



Digital Workstation

PSR-A5000

Owner's Manual

Thank you for purchasing this Yamaha Digital Workstation!

This electric keyboard for professional entertainers not only has a wide selection of Voices and versatile functions but also gives you the potential of expanding content for the instrument.

We recommend that you read this manual carefully so that you can fully take advantage of the advanced and convenient functions of the instrument. We also recommend that you keep this manual in a safe and handy place for future reference.

Before using the instrument, be sure to read "PRECAUTIONS" on pages 5–6.



The model number, serial number, power requirements, etc., may be found on or near the name plate, which is at the bottom of the unit. You should note this serial number in the space provided below and retain this manual as a permanent record of your purchase to aid identification in the event of theft.

Model No.

Serial No.

(bottom_en_01)

**COMPLIANCE INFORMATION STATEMENT
(Supplier's declaration of conformity procedure)**

Responsible Party : Yamaha Corporation of America
Address : 6600 Orangethorpe Ave., Buena Park, Calif. 90620
Telephone : 714-522-9011
Type of Equipment : Digital Keyboard
Model Name : PSR-A5000

This device complies with Part 15 of the FCC Rules.

Operation is subject to the following two conditions:

- 1) this device may not cause harmful interference, and
- 2) this device must accept any interference received including interference that may cause undesired operation.

* This applies only to products distributed by
Yamaha Corporation of America.

(FCC SDoC)

FCC INFORMATION (U.S.A.)

1. IMPORTANT NOTICE: DO NOT MODIFY THIS UNIT!

This product when installed as indicated in the instructions contained in this manual, meets FCC requirements. Modifications not expressly approved by Yamaha may void your authority, granted by the FCC, to use the product.

2. IMPORTANT:

When connecting this product to accessories and/or another product use only high quality shielded cables. Cable/s supplied with this product MUST be used. Follow all installation instructions. Failure to follow instructions could void your FCC authorization to use this product in the USA

3. NOTE:

This product has been tested and found to comply with the requirements listed in FCC Regulations, Part 15 for Class "B" digital devices. Compliance with these requirements provides a reasonable level of assurance that your use of this product in a residential environment will not result in harmful interference with other electronic devices. This equipment generates/uses radio frequencies and, if not installed and used according to the instructions found in the users manual, may cause interference harmful to the operation of other electronic devices. Compliance with FCC regulations does not guarantee

that interference will not occur in all installations. If this product is found to be the source of interference, which can be determined by turning the unit "OFF" and "ON" please try to eliminate the problem by using one of the following measures:

- Relocate either this product or the device that is being affected by the interference.
- Utilize power outlets that are on different branch (circuit breaker or fuse) circuits or install AC line filter/s.
- In the case of radio or TV interference relocate/reorient the antenna. If the antenna lead-in is 300 ohm ribbon lead, change the lead-in to co-axial type cable.

If these corrective measures do not produce satisfactory results, please contact the local retailer authorized to distribute this type of product. If you cannot locate the appropriate retailer, please contact Yamaha Corporation of America, 6600 Orangethorpe Ave. Buena Park CA90620, USA

The above statements apply ONLY to those products distributed by Yamaha Corporation of America or its subsidiaries.

* This applies only to products distributed by YAMAHA CORPORATION OF AMERICA.

(class B)

For the AC adaptor

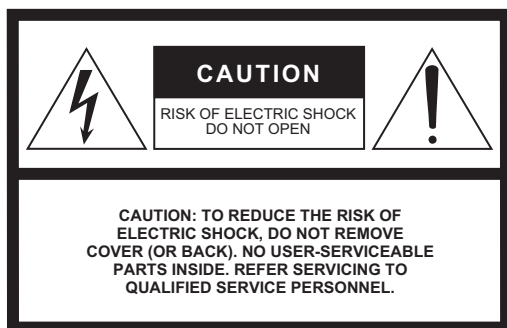

Explanation of Graphical Symbols



The lightning flash with arrowhead symbol within an equilateral triangle is intended to alert the user to the presence of uninsulated “dangerous voltage” within the product’s enclosure that may be of sufficient magnitude to constitute a risk of electric shock to persons.



The exclamation point within an equilateral triangle is intended to alert the user to the presence of important operating and maintenance (servicing) instructions in the literature accompanying the product.

IMPORTANT SAFETY INSTRUCTIONS

- 1 Read these instructions.
- 2 Keep these instructions.
- 3 Heed all warnings.
- 4 Follow all instructions.
- 5 Do not use this apparatus near water.
- 6 Clean only with dry cloth.
- 7 Do not block any ventilation openings. Install in accordance with the manufacturer’s instructions.
- 8 Do not install near any heat sources such as radiators, heat registers, stoves, or other apparatus (including amplifiers) that produce heat.
- 9 Do not defeat the safety purpose of the polarized or grounding-type plug. A polarized plug has two blades with one wider than the other. A grounding type plug has two blades and a third grounding prong. The wide blade or the third prong are provided for your safety. If the provided plug does not fit into your outlet, consult an electrician for replacement of the obsolete outlet.
- 10 Protect the power cord from being walked on or pinched particularly at plugs, convenience receptacles, and the point where they exit from the apparatus.

- 11 Only use attachments/accessories specified by the manufacturer.
- 12 Use only with the cart, stand, tripod, bracket, or table specified by the manufacturer, or sold with the apparatus. When a cart is used, use caution when moving the cart/apparatus combination to avoid injury from tip-over.
- 13 Unplug this apparatus during lightning storms or when unused for long periods of time.
- 14 Refer all servicing to qualified service personnel. Servicing is required when the apparatus has been damaged in any way, such as power-supply cord or plug is damaged, liquid has been spilled or objects have fallen into the apparatus, the apparatus has been exposed to rain or moisture, does not operate normally, or has been dropped.



WARNING

TO REDUCE THE RISK OF FIRE OR ELECTRIC SHOCK, DO NOT EXPOSE THIS APPARATUS TO RAIN OR MOISTURE.

(UL60065_03)

PRECAUTIONS

PLEASE READ CAREFULLY BEFORE PROCEEDING

Please keep this manual in a safe and handy place for future reference.

For the AC adaptor



WARNING

- This AC adaptor is designed for use with only Yamaha electronic instruments. Do not use for any other purpose.
- Indoor use only. Do not use in any wet environments.



CAUTION

- When setting up, make sure that the AC outlet is easily accessible. If some trouble or malfunction occurs, immediately turn off the power switch of the instrument and disconnect the AC adaptor from the outlet. When the AC adaptor is connected to the AC outlet, keep in mind that electricity is flowing at the minimum level, even if the power switch is turned off. When you are not using the instrument for a long time, make sure to unplug the power cord from the wall AC outlet.

For the instrument



WARNING

Always follow the basic precautions listed below to avoid the possibility of serious injury or even death from electrical shock, short-circuiting, damages, fire or other hazards. These precautions include, but are not limited to, the following:

Power supply/AC adaptor

- Do not place the power cord near heat sources such as heaters or radiators. Also, do not excessively bend or otherwise damage the cord, or place heavy objects on it.
- Only use the voltage specified as correct for the instrument. The required voltage is printed on the name plate of the instrument.
- Use the specified adaptor (page 119) only. Using the wrong adaptor can result in damage to the instrument or overheating.
- Use only the supplied power cord/plug.
- Check the electric plug periodically and remove any dirt or dust which may have accumulated on it.

Do not open

- This instrument contains no user-serviceable parts. Do not open the instrument or attempt to disassemble or modify the internal components in any way. If it should appear to be malfunctioning, discontinue use immediately and have it inspected by qualified Yamaha service personnel.

Water warning

- Do not expose the instrument to rain, use it near water or in damp or wet conditions, or place on it any containers (such as vases, bottles or glasses) containing liquids which might spill into any openings. If any liquid such as water seeps into the instrument, turn off the power immediately and unplug the power cord from the AC outlet. Then have the instrument inspected by qualified Yamaha service personnel.
- Never insert or remove an electric plug with wet hands.

Fire warning

- Do not put burning items, such as candles, on the unit. A burning item may fall over and cause a fire.

If you notice any abnormality

- When one of the following problems occur, immediately turn off the power switch and disconnect the electric plug from the outlet. Then have the device inspected by Yamaha service personnel.
 - The power cord or plug becomes frayed or damaged.
 - It emits unusual smells or smoke.
 - Some object has been dropped into the instrument.
 - There is a sudden loss of sound during use of the instrument.
 - If any cracks or breakages exist on the instrument.

CAUTION

Always follow the basic precautions listed below to avoid the possibility of physical injury to you or others, or damage to the instrument or other property. These precautions include, but are not limited to, the following:

Power supply/AC adaptor

- Do not connect the instrument to an electrical outlet using a multiple-connector. Doing so can result in lower sound quality, or possibly cause overheating in the outlet.
- When removing the electric plug from the instrument or an outlet, always hold the plug itself and not the cord. Pulling by the cord can damage it.
- Remove the electric plug from the outlet when the instrument is not to be used for extended periods of time, or during electrical storms.

Location

- Do not place the instrument in an unstable position where it might accidentally fall over.
- Before moving the instrument, remove all connected cables, to prevent damage to the cables or injury to anyone who might trip over them.
- When setting up the product, make sure that the AC outlet you are using is easily accessible. If some trouble or malfunction occurs, immediately turn off the power switch and disconnect the plug from the outlet. Even when the power switch is turned off, electricity is still flowing to the product at the minimum level. When you are not using the product for a long time, make sure to unplug the power cord from the wall AC outlet.

Connections

- Before connecting the instrument to other electronic components, turn off the power for all components. Before turning the power on or off for all components, set all volume levels to minimum.
- Be sure to set the volumes of all components at their minimum levels and gradually raise the volume controls while playing the instrument to set the desired listening level.

Handling

- Do not insert a finger or hand in any gaps on the instrument.
- Never insert or drop paper, metallic, or other objects into the gaps on the panel or keyboard. This could cause physical injury to you or others, damage to the instrument or other property, or operational failure.
- Do not rest your weight on, or place heavy objects on the instrument, and do not use excessive force on the buttons, switches or connectors.
- Do not use the instrument/device or headphones for a long period of time at a high or uncomfortable volume level, since this can cause permanent hearing loss. If you experience any hearing loss or ringing in the ears, consult a physician.

Yamaha cannot be held responsible for damage caused by improper use or modifications to the instrument, or data that is lost or destroyed.

Always turn the power off when the instrument is not in use.

Even when the [] (Standby/On) switch is in standby status (display is off), electricity is still flowing to the instrument at the minimum level.

When you are not using the instrument for a long time, make sure you unplug the power cord from the wall AC outlet.

DMI-7 2/2

NOTICE

To avoid the possibility of malfunction/ damage to the product, damage to data, or damage to other property, follow the notices below.

■ Handling

- Do not connect this product to a public Wi-Fi and/or Internet service directly. Only connect this product to the Internet through a router with strong password protections. Consult your router manufacturer for information on optimum security practices.
- Do not use the instrument in the vicinity of a TV, radio, stereo equipment, mobile phone, or other electric devices. Otherwise, the instrument, TV, or radio may generate noise.
When you use the instrument along with an application on your smart device such as a smartphone or tablet, we recommend that you set "Airplane Mode" to on on that device in order to avoid noise caused by communication.
- Do not expose the instrument to excessive dust or vibrations, or extreme cold or heat (such as in direct sunlight, near a heater, or in a car during the day) to prevent the possibility of panel discoloration, damage to the internal components or unstable operation. (Verified operating temperature range: 5° – 40°C, or 41° – 104°F.)
- Do not place vinyl, plastic or rubber objects on the instrument, since this might discolor the panel or keyboard.

■ Maintenance

- When cleaning the instrument, use a soft cloth. Do not use paint thinners, solvents, alcohol, cleaning fluids, or chemical-impregnated wiping cloths.

■ Saving data

- Edited Song/Style/Voice/MIDI setup data, etc. are lost when you turn off the power to the instrument without saving. This also occurs when the power is turned off by the Auto Power Off function (page 21). Save the data to the instrument, or to USB flash drive/an external device such as a computer (page 33). Saving the data to USB flash drive/an external device is even more secure, since the data in the instrument may be lost due to some failure, an operation mistake, etc. Before using a USB flash drive, make sure to refer to page 108.
- To protect against data loss through USB flash drive damage, we recommend that you save your important data onto spare USB flash drive or an external device such as a computer as backup data.

Main Features

Created to meet the demands of Oriental music entertainers, the PSR-A5000 is an inspirational delight—featuring extraordinary sound, advanced functions, and wonderfully expressive control.

● **Amazingly expressive and realistic Voices**

The PSR-A5000 boasts a comprehensive set of authentic sounding Oriental Voices, including Oud, Nay and Qanoon. The Voices can be played naturally and with great expressiveness—thanks to the new, cutting-edge portamento advancements, featuring velocity and time control.

● **Accompaniment Styles**

The convenient Styles give you full instrument accompaniment, making it possible to perform in a wide variety of music genres simply by playing chords. Naturally, the PSR-A5000's Style content has been created to meet the demands of Oriental music entertainers, and the instrument's Style engine has been localized with new features—including up to 128-note Drum Kits, Drum Key-off samples and support for multiple time signatures within a Style.

● **LIVE CONTROL Joystick, knobs and Assignable buttons—Customized control**

The LIVE CONTROL Joystick and knobs let you intuitively control your performance in real time. A wide variety of functions can be assigned to the Joystick and knobs, so you can easily add variations to the sound during your performance. The Assignable buttons let you set your favorite functions and shortcuts, letting you easily customize the instrument to match your own needs and playing style.

● **Scale Tune—Creating original scales**

The PSR-A5000 features Scale Tune buttons for easy access during live performances. Individual note pitches can be easily modified and stored as your own new scales to Scale Tune Memories. The Scale Tune Quick Setting allows for immediate setting of a desired scale.

● **Chord Looper—Your virtual left hand**

Chord Looper enables you to record a chord sequence and play it back, freeing your left hand from playing chords and providing new opportunities to further enhance your performance.

● **Voice and Style expandability with the Yamaha Expansion Manager**

With Yamaha Expansion Manager software on your computer, you can continually expand the onboard content of the instrument by creating and installing your own custom and downloaded Packs. Supporting WAV, AIFF, SoundFont and even REX format, for handling audio slices, the scope of possibilities for new sounds and styles is virtually unlimited.

● **Audio features, including recording and editing**

Audio files can be played back on the instrument, plus you can directly record your performance as audio files to the internal User drive or a USB flash drive. The instrument also provides a variety of advanced, convenient audio playback and processing functions, including Time Stretch and Pitch Shift. The Vocal Cancel function significantly reduces the volume of existing vocals in an audio file, allowing you to sing “karaoke” style with just the instrumental backing. Since Audio files can also be assigned to Multi Pads and played back during your performance, the creative potential is enormous.

Compatible formats for the instrument



GM (General MIDI) is one of the most common Voice allocation formats. GM System Level 2 is a standard specification that enhances the original GM format and improves Song data compatibility. It provides for increased polyphony, greater Voice selection, expanded Voice parameters, and integrated effect processing.



XG is a major enhancement of the GM System Level 1 format, and was developed by Yamaha specifically to provide more Voices and variations, as well as greater expressive control over Voices and effects, and to ensure compatibility of data well into the future.



GS was developed by the Roland Corporation. In the same way as Yamaha XG, GS is a major enhancement of the GM specifically to provide more Voices and Drum kits and their variations, as well as greater expressive control over Voices and effects.



The Yamaha XF format enhances the SMF (Standard MIDI File) standard with greater functionality and open-ended expandability for the future. This instrument is capable of displaying lyrics when an XF file containing lyric data is played.



SFF (Style File Format) is an original Style file format by Yamaha which uses a unique conversion system to provide high-quality automatic accompaniment based on a wide range of chord types. SFF GE (Guitar Edition) is an enhanced format of SFF, which features improved note transposition for guitar tracks.

Information

■ About copyrights

- Copying of the commercially available musical data including but not limited to MIDI data and/or audio data is strictly prohibited except for your personal use.
- This product incorporates and bundles contents in which Yamaha owns copyrights or with respect to which Yamaha has license to use others' copyrights. Due to copyright laws and other relevant laws, you are NOT allowed to distribute media in which these contents are saved or recorded and remain virtually the same or very similar to those in the product.
 - * The contents described above include computer applications, Accompaniment Style data, MIDI data, WAVE data, voice recording data, a score, score data, etc.
 - * You are allowed to distribute media in which your performance or music production using these contents is recorded, and the permission of Yamaha Corporation is not required in such cases.

■ About functions/data bundled with the instrument

- Some of the preset songs have been edited for length or arrangement, and may not be exactly the same as the original.
- This device is capable of using various types/formats of music data by optimizing them to the proper format music data for use with the device in advance. As a result, this device may not play them back precisely as their producers or composers originally intended.

Yamaha may from time to time update firmware of the product without notice for improvement in functions and usability. To take full advantage of this instrument, we recommend that you upgrade your instrument to the latest version. The latest firmware can be downloaded from the website below:

<https://download.yamaha.com/>

Included Accessories

- Owner's Manual (this book) x 1
 - Online Member Product Registration x 1
 - Music rest x 1
 - AC adaptor, power cord x 1
- May not be included depending on your area. Check with your Yamaha dealer.

About the Manuals

This instrument has the following documents and instructional materials.

Included Documents



Owner's Manual (this book)

Provides overall explanations of the PSR-A5000 basic functions.

Online Materials (downloadable from the Internet)



Reference Manual (only in English, French, German, Turkish, Arabic, and Persian)

Explains advanced features of the instrument, such as creating original Styles, Songs and Multi Pads, and making the settings of specific parameters.



Data List

Contains various important preset content lists such as Voices, Styles, Effects, as well as MIDI-related information.



Smart Device Connection Manual (page 109)

Explains how to connect the instrument to smart devices, such as a smartphone or tablet, etc.



Computer-related Operations (page 110)

Includes instructions on connecting the instrument to a computer, and operations related to transferring song data.

To obtain these materials, access the Yamaha Downloads website, and then enter the model name to search for the desired files.

Yamaha Downloads

<https://download.yamaha.com/>

- The illustrations and LCD screens as shown in this manual are for instructional purposes only, and may appear somewhat different from those on your instrument.
- The displays are taken from the PSR-A5000, and are in English.
- Windows is a registered trademark of Microsoft® Corporation in the United States and other countries.
- Apple, iTunes, Mac, iPhone, iPad, iPod touch and Lightning are trademarks of Apple Inc., registered in the U.S. and other countries.
- The company names and product names in this manual are the trademarks or registered trademarks of their respective companies.

Using the PSR-A5000—a Broad Overview

This section provides a helpful overview of the wide range of functions available in this instrument, and places you can find necessary information on those topics. If you need help in understanding a feature, function or operation—or need to have a general understanding of what the instrument can do and how to effectively use it—look through this section.

OM : PSR-A5000 Owner’s Manual (this book). The relevant chapter names are shown after this symbol. For detailed information on each chapter, see “Contents” (page 12).

* : This material can be obtained from the Yamaha Downloads website (page 9).

Using the PSR-A5000 by itself

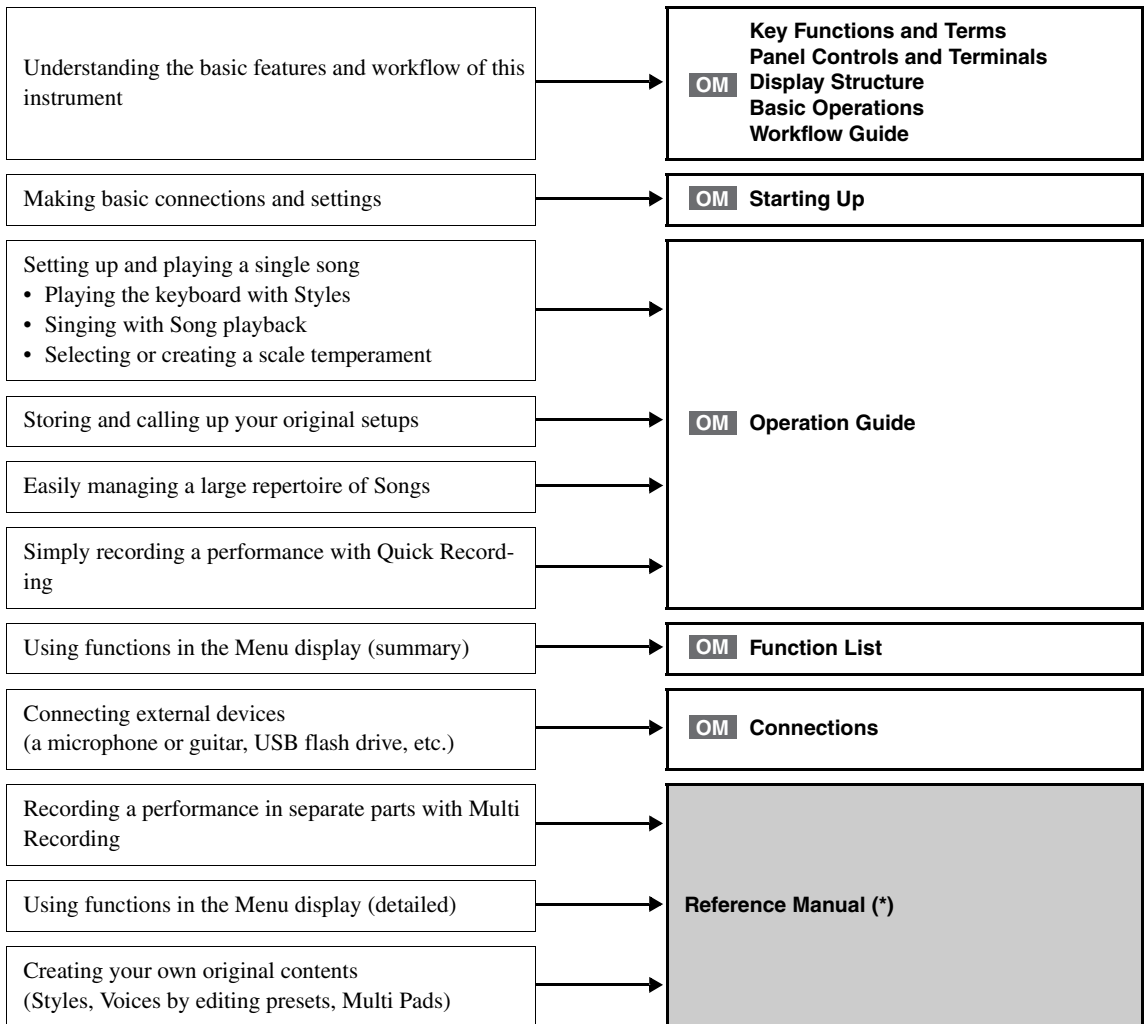
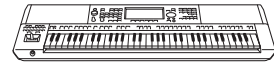

Using the PSR-A5000 with a computer

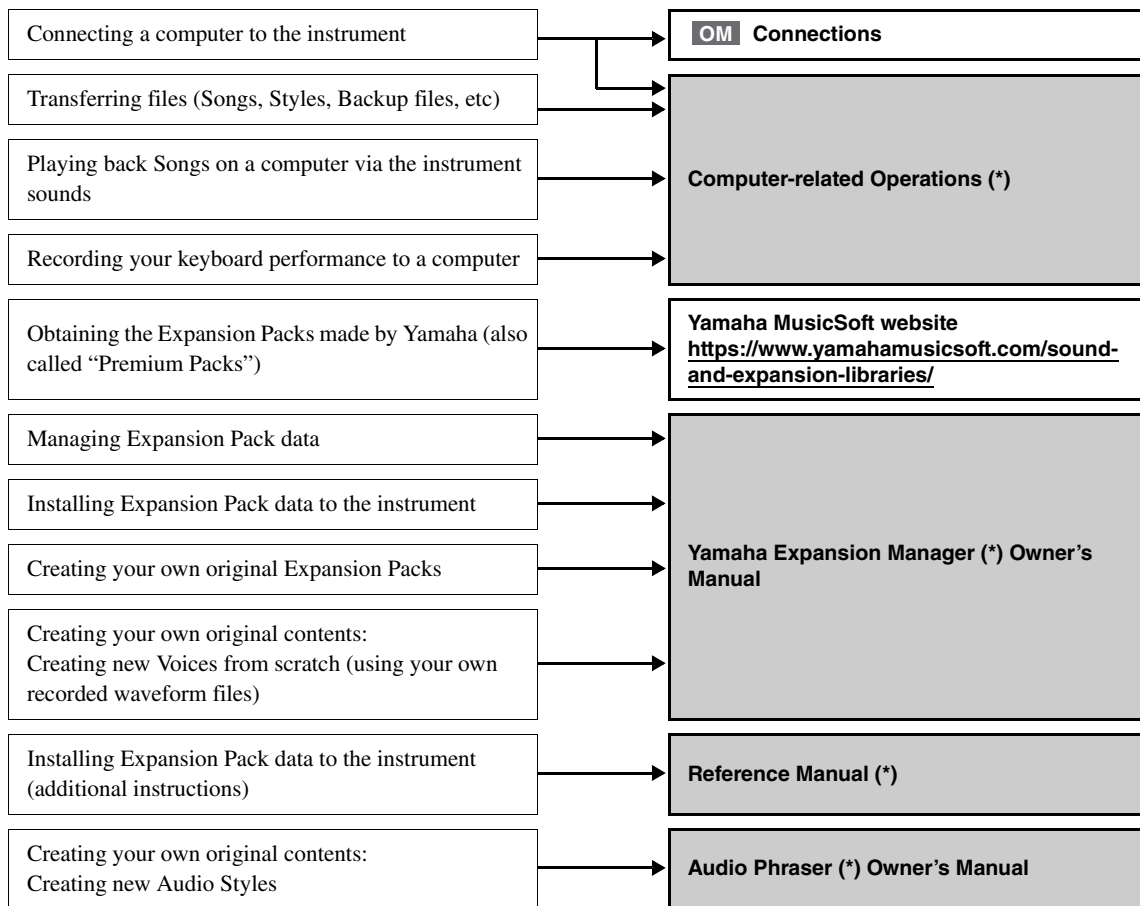
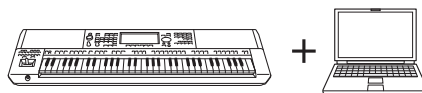

Using the PSR-A5000 with other devices

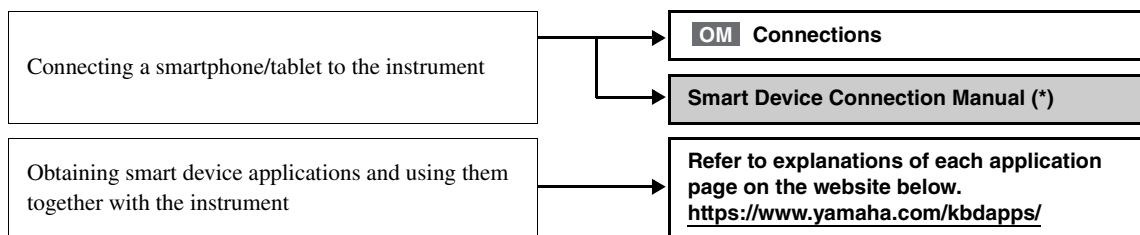
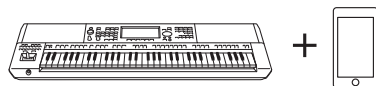

Contents

PRECAUTIONS	5
Main Features	7
Included Accessories	8
About the Manuals	9

Using the PSR-A5000—a Broad Overview...10

Major Functions and Terms...14

Panel Controls and Terminals...16

Starting Up...20

Power Supply	20
Turning the Power On/Off	20
Making Basic Settings	21
Changing the Brightness of the Main Display and Button Lamps	22

Display Structure...23

Main Display Structure	23
------------------------------	----

Basic Operations...26

Display Configuration	26
Closing the Current Display	29
Display-based Controls	30
Calling up the Desired Display Instantly—Direct Access	32
Playing the Demos	32
File Management	33
Entering Characters	36
Locking the Panel Settings (Panel Lock)	37
Using the Metronome	37

Workflow Guide—for Performing on the PSR-A5000...38

Operation Guide 1

Playing with Styles—Setting Up...40

Setting up Styles	40
Optimum Panel Settings for the Current Style (One Touch Setting)	43
Setting up Keyboard Parts	44
Selecting a Voice for Each Keyboard Part	48
Creating Original Organ Flutes Voices	49
Setting up Keyboard Harmony/Arpeggio	50
Setting up Multi Pads	53
Memorizing Original Panel Settings to One Touch Setting	54
Changing the Pitch of the Keyboard	55
Setting up Assignable Controllers	56

Operation Guide 2

Playing with Styles—Operations While Performing...58

Operating Style Playback	58
Recording and Playing Back a Chord Sequence—Chord Looper	60
Expressively Controlling Your Performance	62
Playing and Controlling Super Articulation Voices	63
Controlling Multi Pad Playback	64

Operation Guide 3

Singing with Song Playback—Setting Up...66

Setting Up Song Playback	66
--------------------------------	----

Operation Guide
4

Singing with Song Playback—Operations While Performing...70

Controlling Song Playback 70
 Using Song Position Markers (MIDI Songs only) 73
 Displaying Score, Lyrics, and Text files during Playback 75
 Using the Talk function 77

Operation Guide
5

Selecting and/or Creating a Temperament (Scale Tune)...78

Basic Structure of Scale Tune 78
 Selecting or Creating a Temperament from the Preset Types (Main Scale) 79
 Creating and Using a Temperament (Sub Scale) 80
 Memorizing the Sub Scale Setting 81
 Saving the Scale Tune Memory as a Bank File 82
 Recalling a Memorized Sub Scale Setting 82

Operation Guide
6

Adjusting the Parameters of Each Part—Mixer...83

Basic Procedure for the Mixer 83
 Turning Each Channel of the Style or MIDI Song On/Off 85
 Changing the Voice for Each Channel of the Style or MIDI Song 86

Operation Guide
7

Song Recording...87

MIDI Quick Recording 87
 Audio Quick Recording 88

Operation Guide
8

Storing and Calling up Custom Panel Setups—Registration Memory and Playlist...89

Saving and Recalling Custom Panel Setups with Registration Memory 90
 Managing a Large Repertoire by Using the Playlist 93

Operation Guide
9

Customizing for Optimum Performance...97

Customizing the Shortcuts on the Home Display 97
 Setting the Functions or Shortcuts to the ASSIGNABLE Buttons 97
 Making Global Settings (Utility) 98
 Adjusting the Sound at the Final Output (Master Compressor, Master EQ) 99
 Adding New Contents—Expansion Packs 100

Operation Guide
10

System Settings...101

Confirming the Firmware Version and Hardware ID 101
 Restoring the Factory-programmed Settings 101
 Data Backup and Restore 102

Connections—Using Your Instrument with Other Devices...103

Connecting a Microphone or Guitar ([MIC/GUITAR INPUT] jack) 103
 Using an External Speaker System for Playback (MAIN OUTPUT jacks, SUB (AUX) OUTPUT jacks) 105
 Listening to Audio Playback by the External Device through the Instrument's Speaker 106
 Connecting Footswitches/Foot Controllers (FOOT PEDAL jacks) 107
 Connecting USB Devices ([USB TO DEVICE] terminal) 108
 Connecting to a smartphone/tablet ([USB TO DEVICE], [USB TO HOST], or MIDI terminals) 109
 Connecting to a Computer ([USB TO HOST] terminal) 110
 Connecting External MIDI Devices (MIDI terminals) 110

Function List...111

Appendix...113

Direct Access Chart 113
 Troubleshooting 115
 Specifications 118
 Index 120

Major Functions and Terms

This section briefly explains the key functions of this instrument, to help you better understand the overall capabilities and musical potential.

Styles—Rhythm and Auto Accompaniment

The PSR-A5000 features a variety of accompaniment and rhythmic backing patterns (called “Styles”) in a variety of different musical genres including Arabic music, pop, jazz, and many others. Styles feature sophisticated Auto Accompaniment patterns, letting you produce automatic accompaniment playback simply by playing chords with your left hand. This lets you automatically recreate the sound of a full band or orchestra—even if you’re playing by yourself.

Voices—Individual sounds of the instrument

The PSR-A5000 features a wide variety of exceptionally realistic instrumental Voices, including oriental instruments, piano, guitar, strings, brass, wind instruments and more. The Voices can be played manually on the keyboard, and they are also used by the Styles, MIDI Songs, and Multi Pads.

Keyboard Parts

There are four keyboard parts for your manual performance: LEFT, RIGHT 1, 2 and 3. Each part has one Voice. You can combine these parts by using the PART ON/OFF buttons to create luscious instrument textures and convenient performance combinations. You can change the keyboard range of the Parts by changing the Split Point.

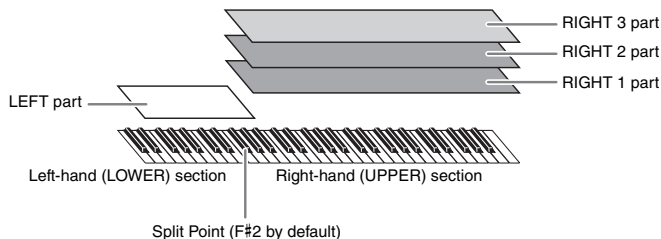

Multi Pads—Adding musical phrases to your performance

The Multi Pads can be used to play a number of short pre-recorded rhythmic and melodic sequences for adding impact and variety to your keyboard performances. Multi Pads are grouped in Banks of four phrases each. This instrument features a variety of Multi Pad Banks in a variety of different musical genres. Moreover, the Audio Link Multi Pad function allows you to create unique, new pad content with your own audio (WAV) data for playing back during your performance.

Songs—Playing back MIDI/audio files

For this instrument, the term “Song” refers to MIDI or audio data, such as preset songs, commercially available files, etc. Not only can you play back a Song and listen to it, but you can also play the keyboard along with Song playback. Song playback features two modes: Song Player mode and Song List mode.

- **Song Player:** Plays back two Songs (one MIDI Song and one Audio Song) simultaneously and allows for a smooth transition between the two.
- **Song List:** Plays back Songs continuously according to a previously created Song List.

Mic/Guitar Connections—Sing/play along with the keyboard performance

By connecting a microphone to the MIC/GUITAR [INPUT] jack (standard 1/4” phone plug connector), you can enjoy singing along with your keyboard performance or with Song playback. The instrument outputs your vocals through the connected speaker system.

The PSR-A5000 lets you connect an electric guitar, and you can even use powerful DSP effects to process the guitar sound instead, and play that along with the keyboard sounds.

Scale Tune—Selecting or Creating a Temperament

The Scale Tune function allows you to select, create and use desired temperament to fit the music you want to play. You can memorize the temperament to Scale Tune Memory buttons and recall it instantly with the buttons during your performance. The memorized settings on five Scale Tune Memory buttons can be saved as a single Scale Tune Memory Bank file.

Registration Memory—Saving and recalling custom panel setups

The Registration Memory function allows you to save (or “register”) virtually all panel settings to a Registration Memory button, and then instantly recall your custom panel settings by simply pressing a single button. The registered settings for eight Registration Memory buttons are saved as a single Registration Memory Bank (file).

Playlist—Managing large amounts of songs and settings

The Playlist function makes it easy to manage and call up your songs and the related settings, no matter how numerous. The Playlist allows you to recall a specific song from more than eight songs by a simple, single step. Up to 2500 songs can be registered in the Playlist, and you can call up the panel settings corresponding to each song by a single tap of the screen.

Recording—Capturing your performances

This instrument allows you to record your performance and save it as a MIDI file in SMF format. The instrument also lets you record your performances as audio data (WAV/MP3) to a USB flash drive or the internal User drive. In addition, MIDI recording also features two convenient recording methods, Quick Recording and Multi Recording.

Panel Controls and Terminals

■ Top Panel

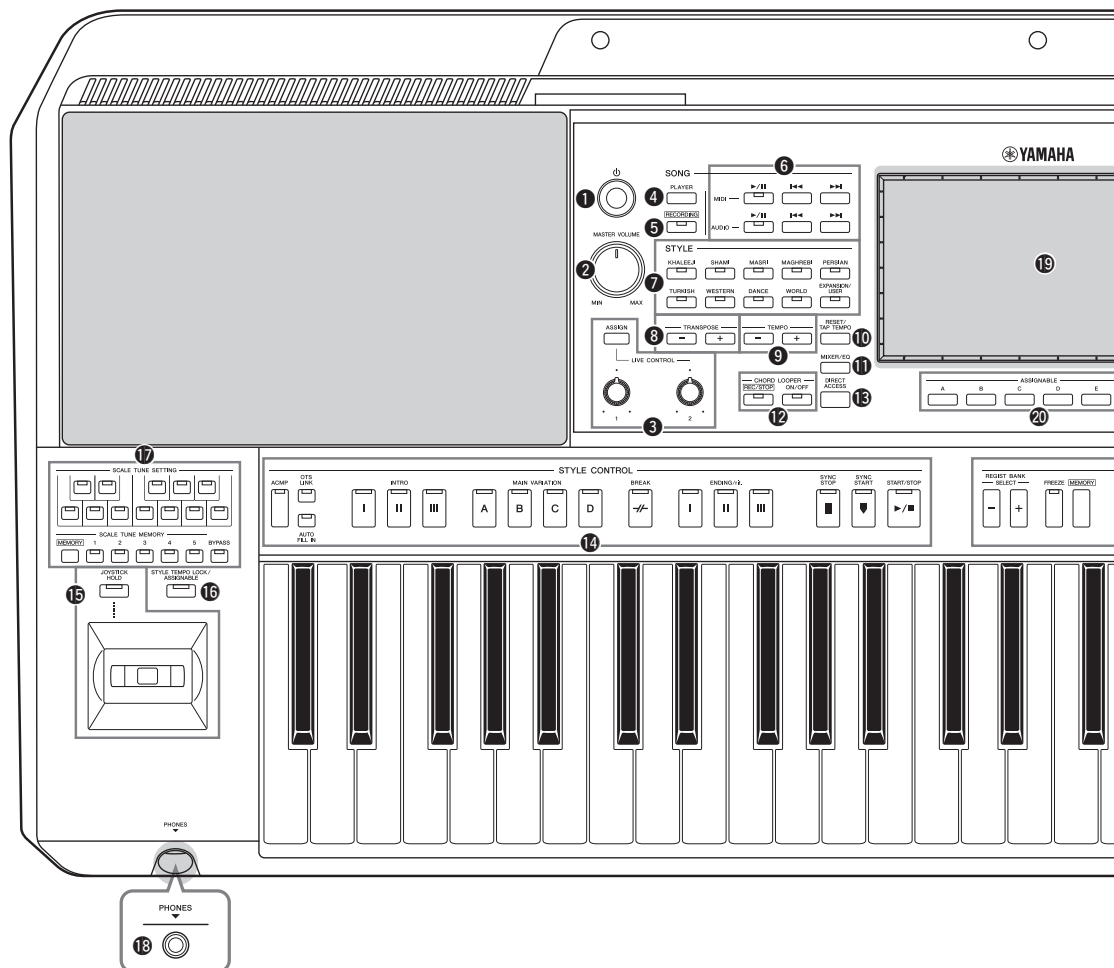

- 1** [⏻] (Standby/On) switch Page 20
Turns on the instrument's power or sets to standby.
- 2** [MASTER VOLUME] dial Page 20
Adjusts the overall volume.
- 3** [ASSIGN] button, LIVE CONTROL knobs
..... Page 56
Assigns functions and controls sounds in real time.
- 4** SONG [PLAYER] button Pages 24, 67
Calls up the Song Player display.
- 5** SONG [RECORDING] button Pages 24, 87
Calls up the Song Recording display.
- 6** SONG playback control buttons..... Page 70
Controls MIDI and Audio Song playback.
- 7** STYLE category selection buttons Page 40
Selects a Style category.
- 8** TRANSPOSE buttons..... Page 55
Transposes the entire pitch of the instrument in semitone steps.
- 9** TEMPO buttons Page 42
Controls the tempo for Style, Song and Metronome playback.
- 10** [RESET/TAP TEMPO] button Pages 42, 59
Allows you to change the tempo by tapping the button twice at the desired tempo. During Style playback, this instantly resets (rewinds) the Style section playback.
- 11** [MIXER/EQ] button Pages 24, 83
Calls up the Mixer display which adjusts the parameters of each part, such as volume, pan, and EQ.
- 12** CHORD LOOPER buttons Page 60
Controls recording and loop playback of the Chord Looper function.
- 13** [DIRECT ACCESS] button..... Pages 32, 113
For instantly calling up the desired display with just a single additional button press.
- 14** STYLE CONTROL buttons..... Pages 40, 58
For controlling Style playback.

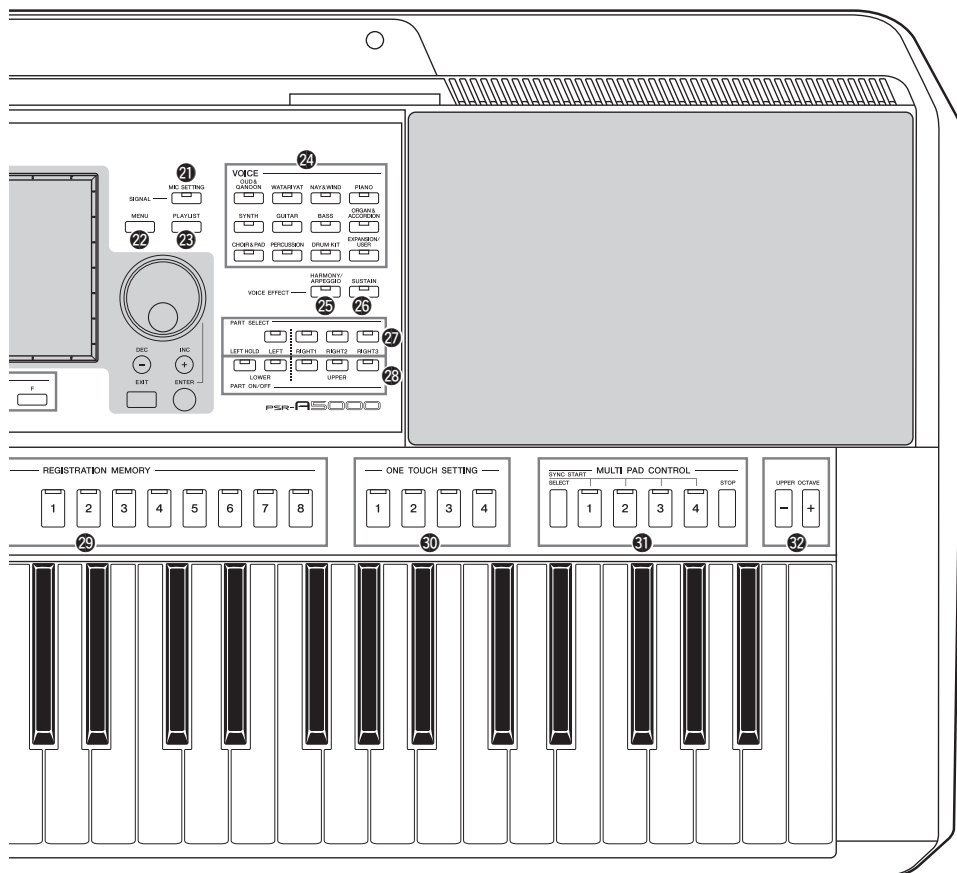

- 15** Joystick, [JOYSTICK HOLD] button Page 62
For using pitch bend, modulation and assigned functions.
- 16** [STYLE TEMPO LOCK/ASSIGNABLE] button Page 57
Controls lock/reset to lock the Style tempo, or turn the assigned function on/off.
- 17** SCALE TUNE SETTING, MEMORY, BYPASS buttons..... Page 78
For controlling and setting up Scale Tune.
- 18** [PHONES] jack Page 19
For connecting a pair of headphones.
- 19** Touch LCD and related controls Page 26
- 20** ASSIGNABLE buttons..... Page 97
For assigning shortcuts to often used functions.
- 21** [MIC SETTING] button Page 104
Calls up the display from which you can make settings for the microphone/guitar.
- 22** [MENU] button..... Pages 25, 29
Calls up the Menu display, which allows you to call up various functions.
- 23** [PLAYLIST] button Pages 25, 93
Calls up the Playlist display.
- 24** VOICE category selection buttons..... Page 48
Selects a Voice category.
- 25** [HARMONY/ARPEGGIO] button Page 50
Applies the Harmony or Arpeggio to the right-hand Voices.
- 26** [SUSTAIN] button Page 63
Applies Sustain to the right-hand Voices.
- 27** PART SELECT buttons..... Page 48
Selects a Voice for each of the keyboard parts.
- 28** PART ON/OFF buttons Page 44
Turns each of the keyboard parts on or off.

- 29 **REGISTRATION MEMORY buttons**..... Page 89
For registering and recalling panel setups.
- 30 **ONE TOUCH SETTING buttons**.....Pages 43, 54
Calls up the appropriate panel settings for the Style.
- 31 **MULTI PAD CONTROL buttons**Pages 53, 64
Selects and plays a rhythmic or melodic Multi Pad phrase.

- 32 **UPPER OCTAVE buttons** Page 55
Shifts the pitch of the keyboard in octave steps.

Panel Setup (Panel Settings)

By using the controls on the panel, you can make various settings as described here. These settings of the instrument are together referred to as “panel setup” or “panel settings” in this manual.

■ **Rear Panel**

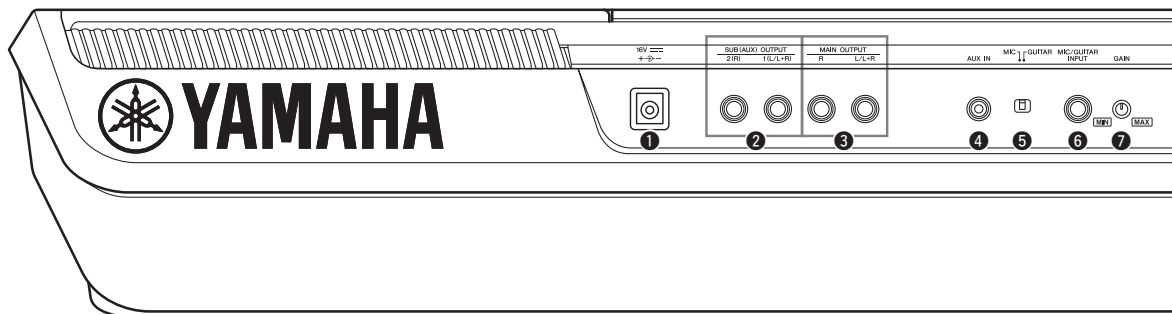

- 1 **DC IN jack**..... Page 20
For connecting the power adaptor.
- 2 **SUB (AUX) OUTPUT [1 (L/L+R)], [2 (R)] jacks** Page 105
For connecting external audio devices. These jacks function as either SUB 1-2 or AUX outputs, depending on the Line Out settings.
- 3 **MAIN OUTPUT [L/L+R], [R] jacks**..... Page 105
For connecting external audio devices.

- 4 **[AUX IN] jack** Page 106
For connecting an external audio device, such as a portable audio player.
- 5 **[MIC GUITAR] switch**Page 103
For switching between “MIC” and “Guitar” for proper use of the [MIC/GUITAR INPUT] jack.
- 6 **[MIC/GUITAR INPUT] jack**Page 103
For connecting a microphone or guitar.

Attaching the Music Rest

Insert the music rest into the slots as shown.

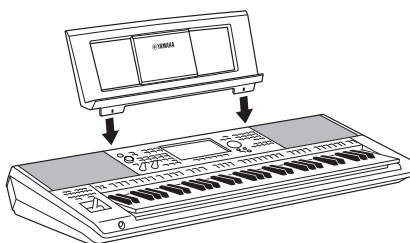

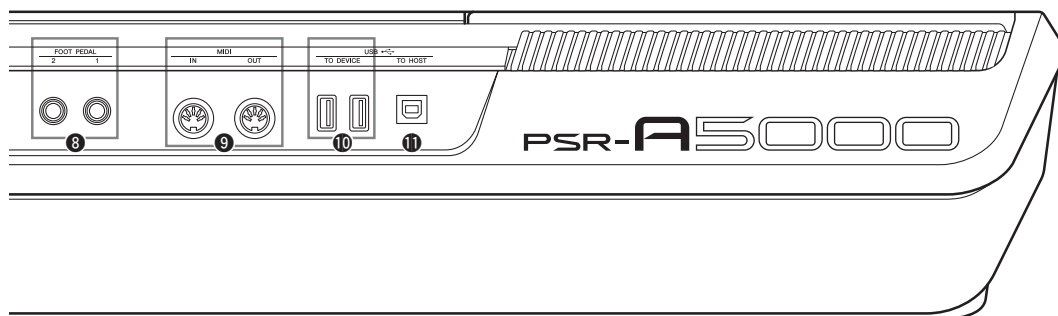

- 7 [GAIN] knob**..... Page 103
 For adjusting the input level of the [MIC/GUITAR INPUT] jack.
- 8 FOOT PEDAL [1], [2] jacks**..... Page 107
 For connecting footswitches and/or foot controllers.
- 9 MIDI [IN], [OUT] terminals**..... Page 110
 For connecting external MIDI devices.
- 10 USB TO DEVICE terminals** Page 108
 For connecting USB devices, such as a USB flash drive, or an optional wireless LAN adaptor, etc.
- 11 [USB TO HOST] terminal**.....Page 110
 For connecting to computer, or an optional wireless MIDI adaptor.

Using the Headphones

Connect a pair of headphones to the [PHONES] jack.

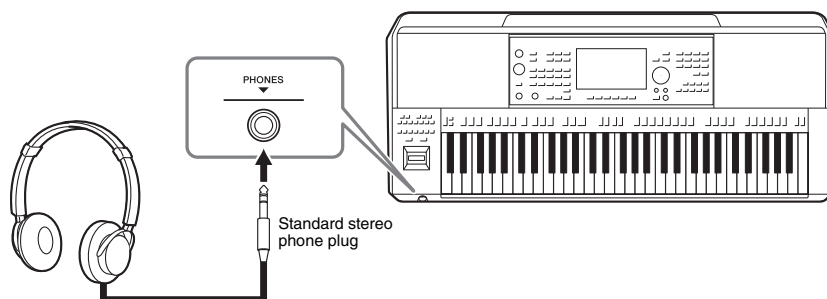

CAUTION

Do not listen with the headphones at high volume for long periods of time. Doing so may cause hearing loss.

Starting Up

Power Supply

Connect the AC adaptor in the order shown in the illustration.

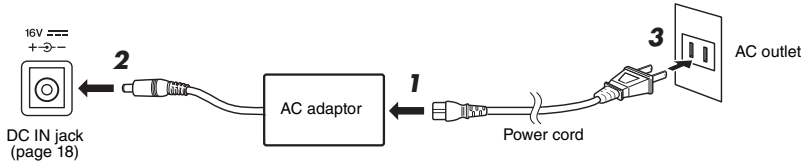

The shape of the plug and outlet differs depending on your area.

WARNING

Use the specified AC adaptor (page 119) only. Using the wrong AC adaptor can result in damage to the instrument or overheating.

CAUTION

When setting up the product, make sure that the AC outlet you are using is easily accessible. If some trouble or malfunction occurs, immediately turn the power off and disconnect the plug from the outlet.

NOTE

Reverse the order shown above (3-2-1) when disconnecting the AC adaptor.

Turning the Power On/Off

- 1 Turn down the [MASTER VOLUME] dial down to “MIN.”

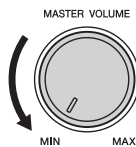

- 2 Press the [⏻] (Standby/On) switch to turn the power on.

After a brief interval, the Home display (page 26) appears. Adjust the volume as desired while playing the keyboard.

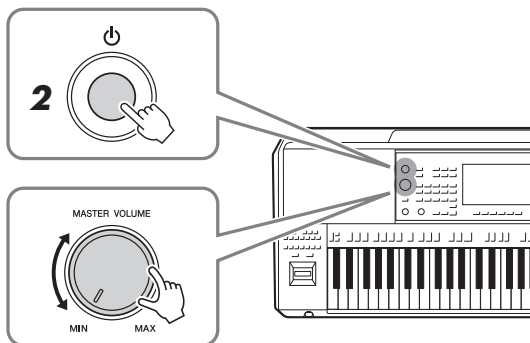

- 3 After you finish using the instrument, turn off the power by pressing and holding the [⏻] (Standby/On) switch for about a second.

NOTE

Until the Home display appears, no operations can be carried out, including power-off and keyboard performance.

CAUTION

Even when the [⏻] (Standby/On) switch is turned off, electricity is still flowing to the product at the minimum level. When you are not using the product for a long time, make sure to unplug the power cord from the wall AC outlet.

NOTICE

When recording or editing, or while a message is displayed, the power cannot be turned off even if you press the [⏻] (Standby/On) switch. If you want to turn off the power, press the [⏻] (Standby/On) switch only after recording, editing, or after the message has disappeared. If you need to force-quit the instrument, hold down the [⏻] (Standby/On) switch for longer than three seconds. Note that the force-quit operation might cause data loss and damage to the instrument.

Auto Power Off function

To prevent unnecessary power consumption, this instrument features an Auto Power Off function that automatically turns the power off if the instrument is not operated for a specified period of time. The amount of time that elapses before the power is automatically turned off is approximately 30 minutes by default; however, you can change the setting (page 21).

NOTICE

Any data which is not saved via the Save operation will be lost if the power automatically turns off. Make sure to save your data before this happens.

Disabling Auto Power Off (simple method)

Turn the power on while holding down the lowest key on the keyboard. A message appears briefly and the Auto Power Off function is disabled.

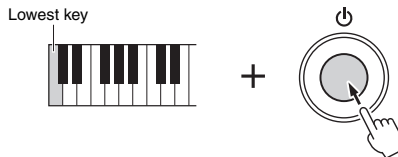

NOTE

When a USB flash drive containing a large number of files is connected to the instrument, the execution of the Auto Power Off function may be postponed, since the file search index is automatically updated.

Making Basic Settings

As necessary, make basic settings for the instrument, such as the language shown on the display.

1 Call up the Utility operation display.

First, press the [MENU] button to call up the Menu display. Then touch [Menu 2] to move to page 2 on the display (if necessary), and touch [Utility].

2 Touch [System] on the display.

3 Make the necessary settings by touching the display.

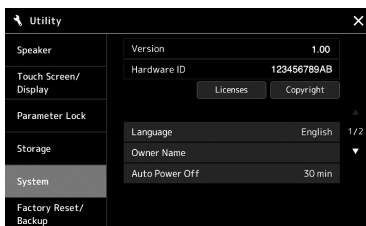

Language	Determines the language used in the display for menu names and messages. Touch this setting to call up the language list, and then select the desired one.
Owner name	Lets you input your name which appears in the opening display (called up when the power is turned on). Touch this setting to call up the character entry window, and then input your name (page 36).
Auto Power Off	Lets you set the amount of time that elapses before the power is turned off by the Auto Power Off function (page 21). Touch this to call up the list of settings, and then select the desired one. To disable Auto Power Off, select "Disabled" here.

For information on the other items in this display, refer to the Reference Manual on the website (page 9).

Changing the Brightness of the Main Display and Button Lamps

Here you can change the brightness of the main display and button lamps.

- 1** Call up the operation display (Utility) (step 1 on page 21).
- 2** Call up the “Touch Screen/Display” display.
Touch [Touch Screen/Display] on the display.
- 3** Change the settings by touching the display.

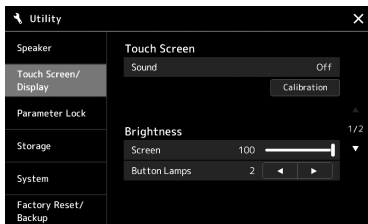

Screen	Use the slider to adjust the brightness of the main display.
Button Lamps	Touch [◀]/[▶] to adjust the brightness of the button lamps.

For information on the other items in this display, refer to the Reference Manual on the website (page 9).

Display Structure

This instrument has an LCD touch screen display and button lamps for visually helping you understand the current status.

LCD (Main Display; touch screen)

The LCD indicates the parameters and values related to the currently selected operation. You can operate by touching the 'virtual' buttons or sliders on the display. For details on the display structure, see below.

Panel buttons and lamps

Many of the panel buttons have colored lamps that indicate the corresponding function statuses by lighting on/off, flashing, or changing in color. For details on the lighting rules and indications, refer to the relevant function's description.

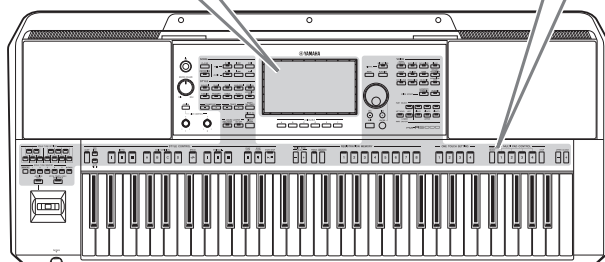

Main Display Structure

When the instrument is turned on, the Home display is called up. By touching the display, you can call up the various functions.



Home display

This is portal of the instrument's display structure, which provides at-a-glance information on all current settings. (page 26)

However, as you operate the instrument, you can directly call up displays dedicated to each main function directly by pressing the corresponding buttons on the front panel. Other functions and various detailed settings for the instrument can be accessed from the Menu display. Also, depending on the particular function, you can call up the File Selection display to select desired files.

The next page shows an overview of how to call up each major function display.

How to call up the major function displays by the buttons

This map shows how to call up the displays for each key function by the buttons on the panel.

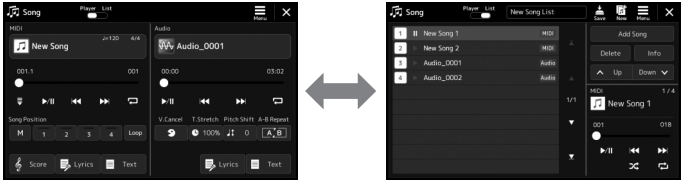

Song Playback display
This is for controlling Song playback (pages 66, 70).

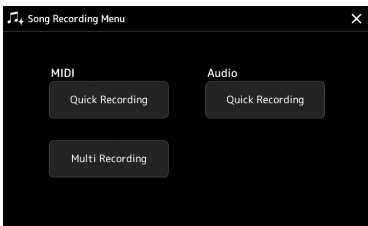

Song Recording display
For recording your performance (page 87).

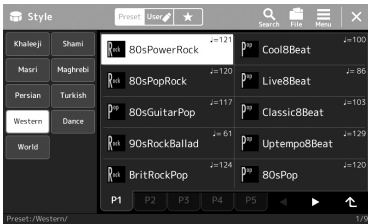

Style Selection display
One of the File Selection displays (page 28) for selecting Styles.

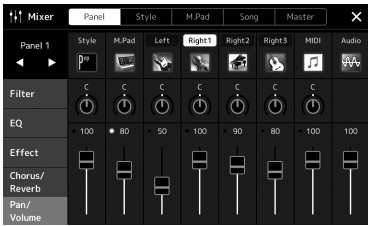

Mixer display
For adjusting the parameters of each part, such as volume, pan, and EQ (page 83). It also allows you to adjust overall sound controls, by Master Compressor and Master EQ (page 99).

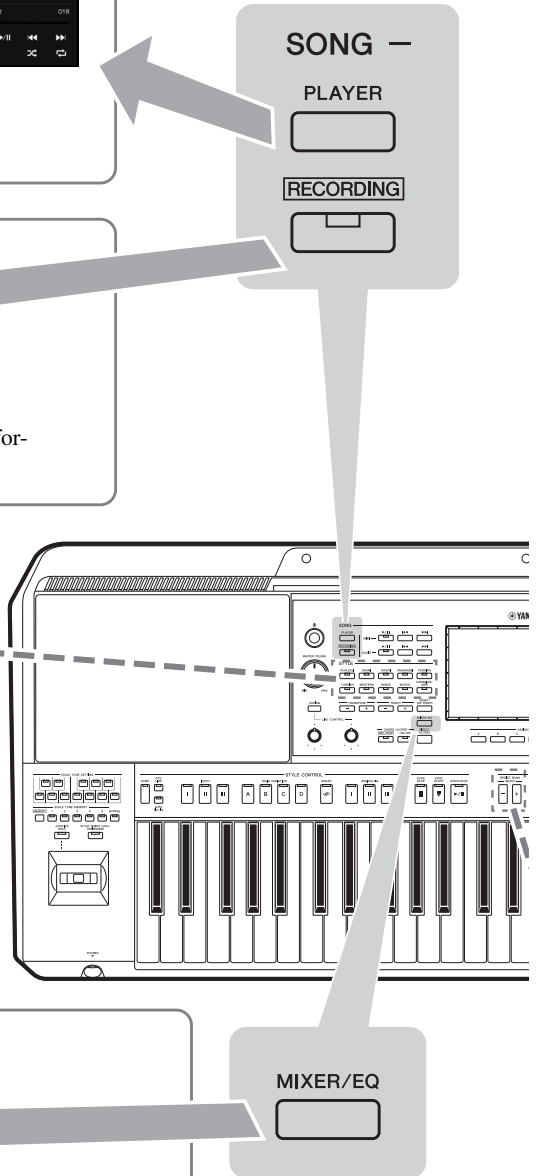

Menu display
By touching each of the icons, you can call up various functions, such as Song Score, Volume Balance and other detailed settings. (page 29)

Mic Setting display
This is for making settings for the microphone or the guitar sound (page 104).

Playlist display
This is for selecting and editing Playlists. (page 93)

Voice Selection display
One of the File Selection displays for selecting Voices for the keyboard parts (page 48).

Multi Pad Selection display
One of the File Selection displays for selecting a Multi Pad Bank (page 53).

Registration Memory Bank Selection display
One of the File Selection displays for selecting Registration Memory Bank (page 91).

Basic Operations

Display Configuration

This section covers the most often used displays: Home, File Selection and Menu. The Home display appears when the power is turned on. The term “File Selection display” refers to all the various displays called up on the instrument from which you can select files. The Menu display is a portal display for various functions and can be called up by pressing the [MENU] button.

Home Display

Appears when the power is turned on. This display shows the current basic settings such as the current Voice and Style, allowing you to see them at a single glance. Because of this, you should normally have the Home display shown when you perform on the keyboard.



1 Voice area

Indicates the current Voices for each of the keyboard parts (Left and Right 1–3) and the on/off status of the four parts. Touching a Voice name calls up the Voice Selection display for the corresponding part.

2 Song area

Indicates information related to Song playback/recording. The information on Song playback is displayed depending on the Song playback mode (page 67). Touching the file name calls up the relevant selection display. When in recording, the recording status is displayed. Touching the recording status calls up the recording display.

3 Style area

Indicates information for the current Style, such as the current position of the section playback, the current chord name, and the time signature. Touching a Style name calls up the Style Selection display. When the [ACMP] button is set to on, the chord specified in the chord section of the keyboard will be displayed.

4 Multi Pad area

Indicates the current Multi Pad Bank. Touching a Multi Pad Bank name calls up the Multi Pad Bank Selection display.

5 Other Information area

Indicates the current status, such as the current Registration Memory or Scale Tune information. For details, see below.

6 Shortcut area

Contains the shortcut icons which let you call up various functions with a single touch. Touching a shortcut icon calls up the display of the corresponding function. You can also register your own custom shortcut icons as desired here, via the Assignable display (page 97).

■ Other Information area in the Home display

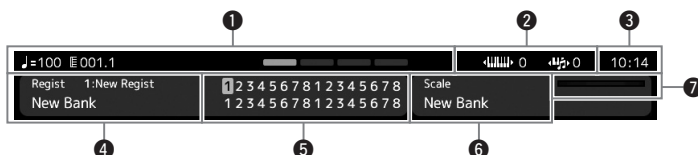

1 Bar/Beat/Tempo

Displays the current position (bar/beat/tempo) in Style playback or MIDI Song playback. By rotating the Data dial, you can call up the Tempo pop-up display and adjust the tempo.

2 Upper Octave/Transpose

Displays the amount by which the upper octave value is shifted, and the amount of master transposition in semitone units (page 55).

3 Clock

Once this instrument has accessed the network via the USB Wireless LAN Adaptor, the current time is shown here.

4 Registration Memory Bank

Indicates the currently selected Registration Memory Bank name and Registration Memory number. Touching a Registration Memory Bank name calls up the Registration Memory Bank Selection display.

5 Registration Sequence

Appears when the Registration Sequence is active. For instructions on programming the sequence, refer to the Reference Manual on the website.

6 Scale Tune

Indicates the currently selected Scale Tune Memory Bank name and Scale Tune Memory number with its name. Touching a Scale Tune Memory Bank name calls up the Scale Tune Memory Bank Selection display.

7 MIC/GUITAR Input level indicator

When a microphone or guitar is connected, this indicates the input level. Adjust the level with the [GAIN] knob so that the indicator lights in green or yellow (but not in red). For details on connecting a microphone or guitar, refer to page 103.

File Selection Display

The File Selection display is for selecting a Voice, Style, Song, Multi Pad set and other items. You can call up this display by touching the name of the Voice, Style or Song on the Home display, or by pressing one of the VOICE buttons or STYLE buttons, etc. The displays differ depending on which file type is selected. For example, when Voice is selected, the Voice Selection display is called up.

This section explains the display structures common to all types of the File selection displays.

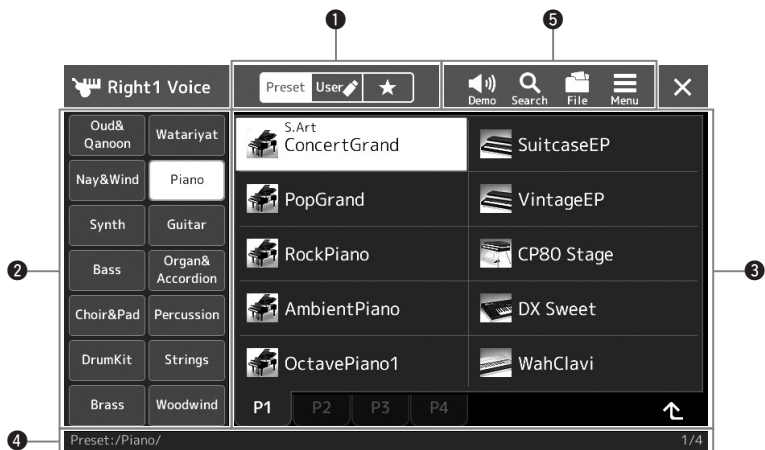

1 Main Category

For selecting the Preset, User, or Favorite tab.

Preset	Location where preset data are available. A wide variety of data such as Voices and Styles are divided into several sub categories (tabs).
User	Location where recorded or edited data is saved. Data saved to the instrument are shown in “User” (User drive), while data in the connected USB flash drive are shown in “USB.” In this manual, data in the User tab are referred to as “User data.”
Favorite	Location where the data which you have registered as Favorites are shown. This tab may not be shown depending on the data type.

2 Sub Category / Drives

- When the Preset tab is selected in the main categories, the sub categories are shown here according to the data type. For example, various instrument types such as Piano are shown on the Voice Selection display.
- When the User tab is selected, the drives available are shown as sub categories.

3 Selectable data (files)

The files that can be selected are shown. If two or more pages are available, you can call up another page by touching the desired page tab at the bottom of this area.

4 Folder Path

The current path or folder is shown here according to the folder structure.

5 Operation icons

The functions (save, copy, delete, etc.) which can be operated via the File Selection display are shown. The icons shown here differ depending on which File Selection display is selected. For detailed instructions, refer to “File Management” (page 33), or the instructions for each function’s File Selection display.

Menu Display

This is the portal display for using various functions and can be called up by pressing the [MENU] button.

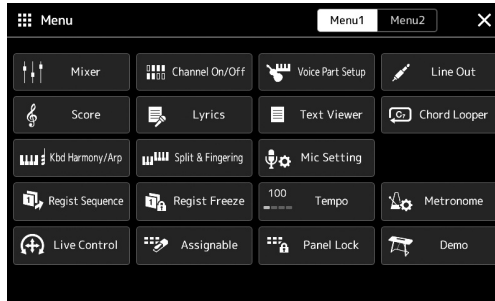

Various convenient functions are shown via icons, and touching one of them calls up the corresponding function. This list consists of two pages, which you can select by touching [Menu 1] or [Menu 2], or pressing the [MENU] button several times. For brief information on each function, refer to the “Function List” (page 111).

 **NOTE**

You can also change pages by flicking horizontally.

Instruction conventions for the Menu display

Throughout this manual, instructions with multiple steps are given in convenient shorthand, with arrows indicating the proper sequence.

Example: [MENU] → [Utility] → [System] → [Language]

The example above describes a four step operation:

- 1) Press the [MENU] button to call up the Menu display.
- 2) From the Menu display, touch [Utility].
- 3) Touch [System].
- 4) Touch [Language].

Closing the Current Display

To close the current display, press the [EXIT] button or touch  at the upper right of the display (or window) or [Close] at the lower right of pop-up displays. When a message (information or confirmation dialog) appears, touching the appropriate item such as “Yes” or “No” closes the message.

If you want to instantly return to the Home display, press the [DIRECT ACCESS] and [EXIT] buttons simultaneously.

Display-based Controls

The display of this instrument is a special touch screen that allows you to select or change the desired parameter by simply touching the corresponding setting on the display. You can also decrease/increase the value in small steps by rotating the Data dial or pressing the [DEC]/[INC] button.

Using the display (touch screen)

NOTICE

Do not use any sharp or hard tools to operate the touch screen. Doing so may damage the display.

NOTE

Keep in mind that operation by simultaneously touching two or more points on the display is not possible.

Touch

To select an item, lightly touch the corresponding indication on the display.

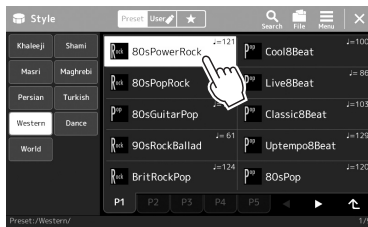

NOTE

If you find the system sounds (produced when touching the display) distracting, you can turn them on/off from [MENU] → [Utility] → [Touch Screen/Display] → Touch Screen [Sound]

Slide

Hold down the display slider, and then slide your finger vertically or horizontally to change the parameter value.



NOTE

In the case of a vertical slider, the slide operation is only effective for the slider when it is selected. To select a slider, touch it once. The selected state is indicated by a surrounding orange frame.

Rotate

Touch and hold the display knob, and rotate your finger around the knob to change the parameter value.



NOTE

The rotate operation is only effective for the knob when it is selected. To select a knob, touch it once. The selected state is indicated by a surrounding orange frame.

Touch and hold

This instruction means to touch the object in the display and hold it for a while.

When setting values by using the [◀]/[▶] buttons, a slider or a knob, you can restore the default value by touching and holding the value on the display.



Using the Data dial, [ENTER] button, and [DEC]/[INC] buttons

Depending on the display, the Data dial and the buttons can be used in the following two ways.

■ Adjusting the parameter values

After selecting the desired parameter by touching it, use the Data dial or the [DEC]/[INC] buttons to adjust the value. This is useful if you have difficulty adjusting by touching on the display, or want finer control over the adjustment.

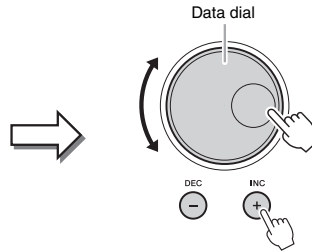
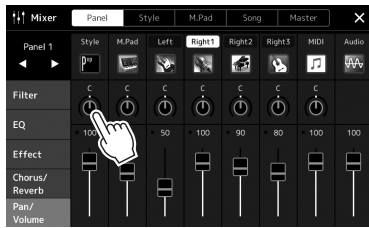

■ Loading/Selecting an item from a list

When a list such as File Selection displays or pop-up windows for setting parameters, use the Data dial and the [DEC]/[INC] buttons to select an item.

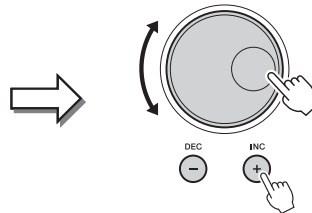
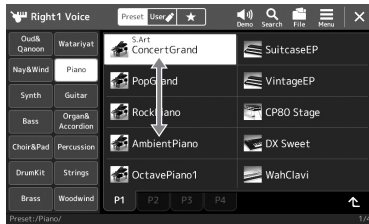

Rotate the dial or press the [DEC]/[INC] buttons to actually load/select the item. Whether the item is loaded or only selected depends on the setting in the display called up via [MENU] → [Utility] → [Touch Screen/Display]. For details, refer to the "Utility" of the Reference Manual on the website.

Calling up the Desired Display Instantly—Direct Access

With the convenient Direct Access function, you can instantly call up the desired display—with just a single additional button press. Refer to the “Direct Access Chart” on page 113 for a list of the displays that can be called up with the Direct Access function.

1 Press the [DIRECT ACCESS] button.

A message appears in the display prompting you to press the appropriate button.

2 Press the button (or move the knob, joystick or connected pedal) corresponding to the desired setting display to instantly call up that display.

For example, pressing one of the REGISTRATION MEMORY [1]–[8] buttons calls up the Regist Bank Info display (page 92).

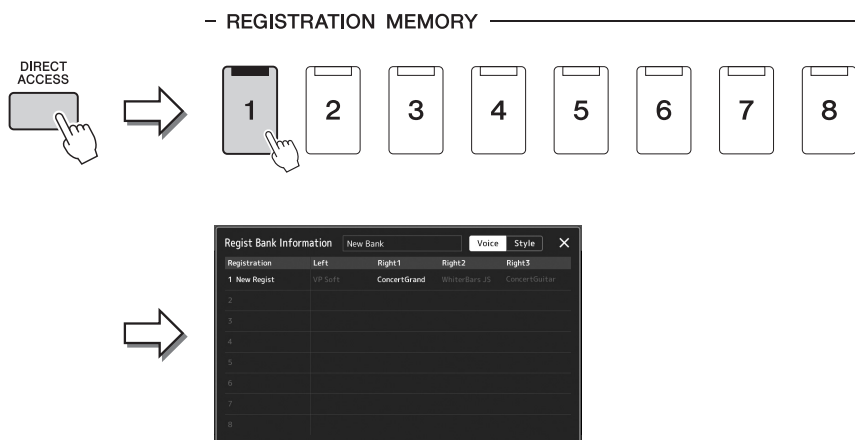

Playing the Demos

The Demos provide dynamic demonstrations of the high-quality sounds.

1 Call up the Demo display via [MENU] → [Demo].

2 Touch the display to show and play the desired Demo.

3 To return to the Demo display, press the [EXIT] button, or tap the Close button on the display.

4 Press the [EXIT] button to exit from the Demo display.

File Management

Data you have created such as recorded Songs and edited Voices can be saved as files to the instrument (referred to as “User drive”) or a USB flash drive. If you’ve saved a lot of files, you may have trouble finding the desired file quickly. To make operation easier, you can organize your files in folders, rename the files, delete unnecessary files, etc. These operations are done in the File Selection display.

NOTE

Before using a USB flash drive, be sure to read “Connecting USB Devices” on page 108.

Restrictions for Preset Songs

Preset Songs are copy protected to prevent illegal copying or accidental erasure. These can only be copied or saved to the User drive, and cannot be moved or deleted.

Saving a file

You can save your original data (such as Songs you’ve recorded and Voices you’ve edited) as a file to the User drive or the USB drive in the File Selection display (page 28).

1 In the relevant File Selection display (*), touch (File Edit) to call up the File Edit pop-up window.

* For example, the display shown below (Voice Selection) is called up via the PART SELECT [RIGHT 1] button.

NOTE

To cancel the file operation, press the [EXIT] button.

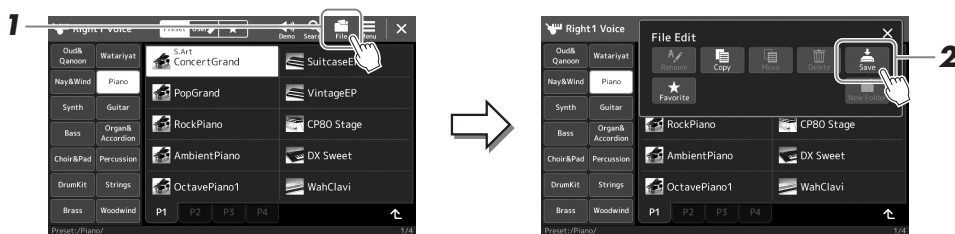

2 Touch [Save] to call up the display for selecting the saving destination.

3 Select the location to which you want to save the file.

To show the next higher level folder, touch  (Up).



4 Touch [Save here] to call up the Character Entry window.

5 Enter the file name (page 36).

Even if you skip this step, you can rename the file at any time (page 34) after saving.

NOTE

To cancel this operation, touch [Cancel].

6 Touch [OK] in the Character Entry window to actually save the file.

The saved file will be automatically located at the appropriate position among the files in alphabetical order.

Creating a new folder

Folders can be created, named and organized as desired, making it easier to find and select your original data.

1 In the File Selection display, touch the User tab (page 28), and then select the location to which you want to create a new folder.

To show the next higher level folder, touch  (Up).

2 Touch (File Edit) to call up the File Edit pop-up window.

3 Touch [New Folder] to call up the Character Entry window.

4 Input the name of the new folder (page 36).

NOTE

The maximum number of files/folders which can be stored in a folder is 2500.

NOTE

A new folder cannot be created in the Preset tab or the "Expansion" folder (page 100) in the User tab.

Renaming a file/folder

You can rename files/folders.

1 Call up the File Selection display, on which the desired file/folder is shown.

2 Touch (File Edit) to call up the File Edit pop-up window.

3 Touch [Rename] in the File Management menu, to call up the display for selecting the desired file/folder.

4 Select the desired file or folder by touching it.

5 Touch [Rename] at the top of the display to call up the Character Entry window.

6 Input the name of the selected file or folder (page 36).

NOTE

Files in the Preset tab or the "Expansion" folder (page 100) in the User tab cannot be renamed.

NOTE

Only one file or folder can be renamed at a time.

Copying or moving files

You can copy or cut a file and paste it to another location (folder). You can also copy a folder (without moving it) by using the same procedure.

1 Call up the appropriate File Selection display, on which the desired files/folders are shown.

2 Touch (File Edit) to call up the File Edit pop-up window.

3 Touch [Copy] or [Move] in the File Management menu, to call up the display for selecting the desired files/folders.

NOTE

- Files in the Preset tabs cannot be copied/moved.
- Files in the "Expansion" folder (page 100) in the User tab cannot be copied/moved.

4 Select the desired files/folders by touching each item.

One or more files/folders can be selected (highlighted). To cancel the selection, touch the same item again.

Touch [Select All] to select all items indicated on the current display including the other pages. To cancel the selection, touch [All Off].

5 Touch [Copy] or [Move] at the top of the display, to call up the display for selecting the destination.**6 Select the desired destination (path) to paste the files/folders.****7 Touch [Copy here] or [Move here] to paste the files/folders you've selected in step 4.**

The pasted file/folder appears on the display at the appropriate position among the files in alphabetical order.

NOTE

To cancel this operation, touch [Cancel] before going to step 7.

Deleting files/folders

You can delete files/folders.

1 Call up the appropriate File Selection display, on which the desired files/folders are shown.**2 Touch  (File Edit) to call up the File Edit pop-up window.****3 Touch [Delete] in the File Management menu, to call up the display for selecting the desired files/folders.****4 Select the desired files/folders by touching each item.**

One or more files/folders can be selected (highlighted). To cancel the selection, touch the same item again.

Touch [Select All] to select all items indicated on the current display including the other pages. To cancel the selection, touch [All Off].

5 Touch [Delete] at the top of the display.

A confirmation message appears. To cancel this operation, touch [No] before going to step 6.

6 Touch [Yes] to actually delete the files/folders you've selected in step 3.**NOTE**

Files in the Preset tabs or the "Expansion" folder (page 100) in the User tab cannot be deleted.

Registering files to the Favorite tab

You can call up your favorite or often used Style or Voice files quickly by registering them to the Favorite tab. For details, refer to the Reference Manual on the website (page 9).

Searching for files

You can search for desired files by name, on the display called up by touching  (File Search). In the case of Registration Memory Bank files, you can also search for them by specifying other detailed properties. For details, refer to the Reference Manual on the website (page 9).

Entering Characters

This section covers how to enter characters for naming your files/folders, inputting keywords when searching for files, etc. Entering characters is done in the display shown below.



1 Touch the character type.

Touching [Symbol] (or [abc]) switches between entering symbols or Roman letters (and numbers).

To switch between entering capital letters or small letters, touch  (Shift).

2 Touch [◀]/[▶], rotate the Data dial or the press [DEC]/[INC] buttons to move the cursor to the desired location.

3 Input the desired characters one by one.

To delete a single character, touch [Delete]; to delete all characters at once, touch and hold [Delete]. To enter a space, touch the space key indicated in the illustration above.

To input letters with auxiliary symbols:

You can input letters with auxiliary symbols, such as an umlaut, by touching and holding a letter to call up a list. For example, touch and hold “E” to enter “Ë” from the list.

To select custom icons for files (shown at left of file name):

You can select custom icons for the file. Touch [Icon] to call up the pop-up window, and then select the desired icon.

4 Touch [OK] to finalize the characters (name, keywords, etc.) you have input.

NOTE

- Depending on the display for character entry you are working in, some types of characters cannot be entered.
- A file name can contain up to 46 characters and a folder name can contain up to 50 characters.
- The following characters (half size) cannot be used: \ / : * ? * < > |

NOTE

To cancel this operation, touch [Cancel] before going on to step 4.

Locking the Panel Settings (Panel Lock)

When the panel settings are locked, nothing happens, even when you press any of the panel buttons. For example, when you take a break during your performance and leave the instrument unattended, this feature protects the panel settings from being accessed by others.

1 Call up the Panel Lock display via [MENU] → [Panel Lock].

The numeric keypad for PIN code entry is called up.

2 Input a four-number PIN code by touching the numeric keypad, and then touch [OK] to enter it.

The panel settings are locked. The main display is also in “lock” mode during the panel lock.

3 To unlock the instrument, touch the display, then input the same PIN code you entered in step 2.

NOTE

If you have forgotten the PIN code, simply turn the power off and back on again to unlock the instrument.

Using the Metronome

The metronome provides a click sound, giving you an accurate tempo guide when you practice, or letting you hear and check how a specific tempo sounds. When recording without Style playback, turning the metronome on makes your recording sessions much more efficient.

1 Call up the Metronome display via [MENU] → [Metronome].

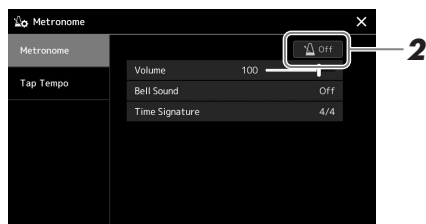

2 Touch the icon to turn the metronome On/Off.

For information on the other items on the display, refer to “Metronome Settings” of the Reference Manual on the website.

NOTE

The Metronome can also be turned on/off by touching the Metronome On/Off button on each recording display. (page 87)

Workflow Guide—for Performing on the PSR-A5000

■ Creating panel settings manually and performing a single song

Playing the keyboard with Styles (Auto Accompaniment)

Setting up the Style
... p. 40

Optimum panel settings for the current Style (One Touch Setting) ... p. 43

Calling up the most appropriate panel settings (Keyboard Parts, Harmony/Arpeggio, or Multi Pads) for the selected Style.

or

Setting up the Voices ... p. 44
(Setting up keyboard parts)

Setting up Harmony/Arpeggio ... p. 50

or
Singing with Song playback

Making Song playback settings ... p. 66

■ Storing the song's panel settings for easy recall

Storing the song's panel settings to Registration Memory ... p. 90

For details about Registration Memory and Registration Memory Bank, refer to page 89.

■ Calling up the stored panel settings for your performance

Selecting the desired Registration Memory Bank file

Calling up the Registration Memories 1–8 for the Bank file. (p. 91)

Calling up the desired song's panel settings from the Playlist in a single step

Selecting the desired Playlist Record for calling up the corresponding linked Registration Memory. (p. 95)

■ Recording your keyboard performance

Recording setup: Calling up a Registration Memory from the Playlist, etc.

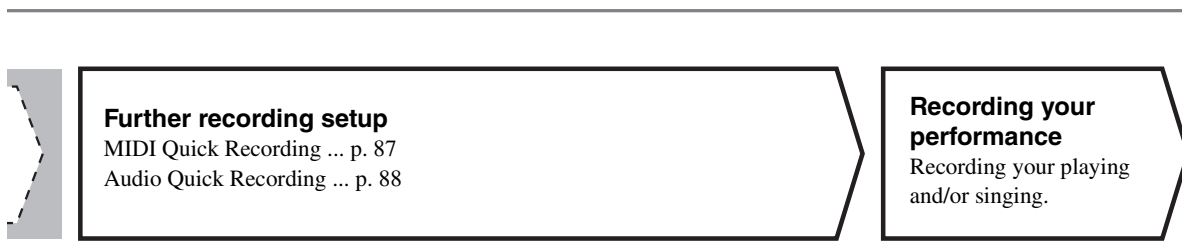
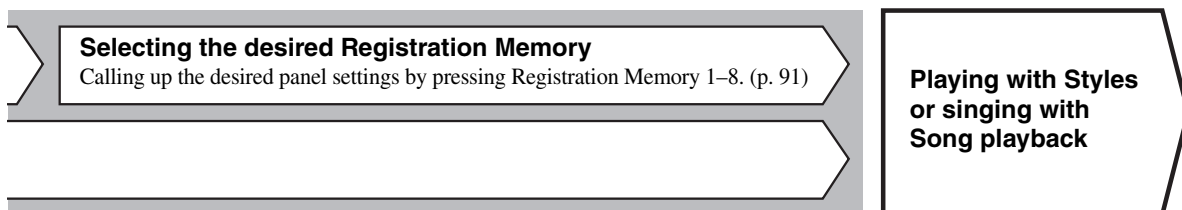
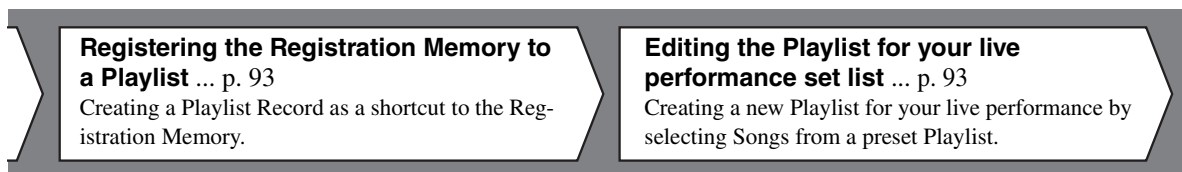
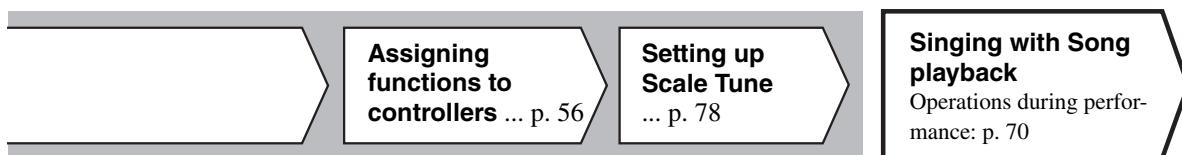
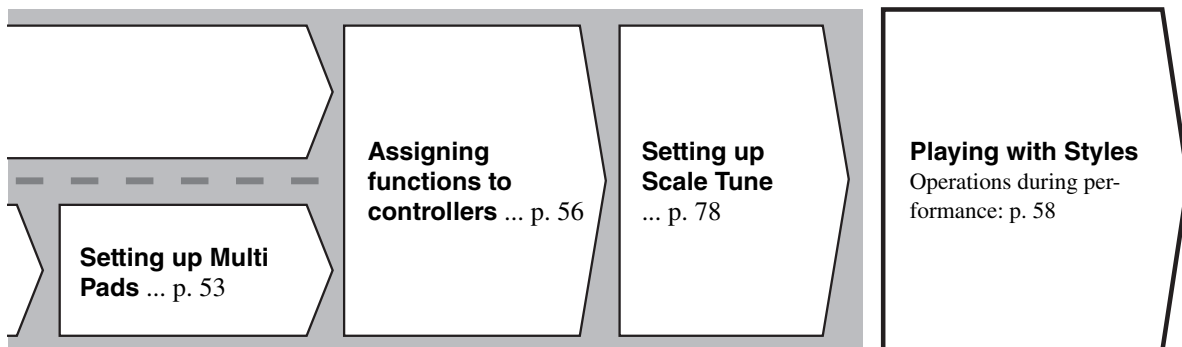

Playing with Styles—Setting Up

This section gives you basic steps on how to enhance your keyboard performance with Styles (Rhythm and Auto Accompaniment). Follow the various instructions below for completely setting up your performance of a single Song, including a Style, Keyboard Parts (Voices), Multi Pad, and various types of controllers.

The settings made in this section can be collectively stored in the Registration Memory as one song setting (page 89).

Setting up Styles

Selecting the desired Style and turning Auto Accompaniment (ACMP) on

- 1 Press one of the **STYLE** category selection buttons to call up the **Style Selection** display.

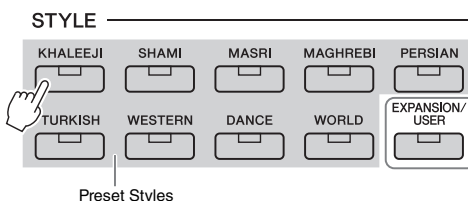

- **Expansion Styles**
Styles additionally installed (page 100).
- **User Styles**
Styles created with the Style Creator function (refer to the Reference Manual on the website), or Styles copied to the User drive (page 34).

NOTE

You can also call up the Style Selection display via the Home display (page 26).

- 2 Touch the desired **Style**.

For example, touch the category [Western], and then [80sPowerRock].

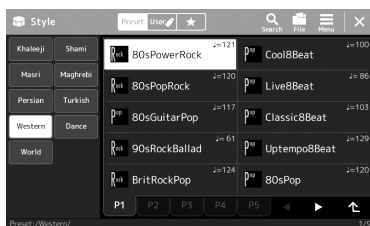

NOTE

For basic operations of the Style Selection display, refer to "File Selection Display" (page 28).

- 3 Press the **STYLE CONTROL [ACMP]** button to turn on the **Auto Accompaniment**.

When the button is turned on, both the rhythm part and auto accompaniment can be played back during Style playback.

NOTE

The Split Point can be changed as desired (page 45).

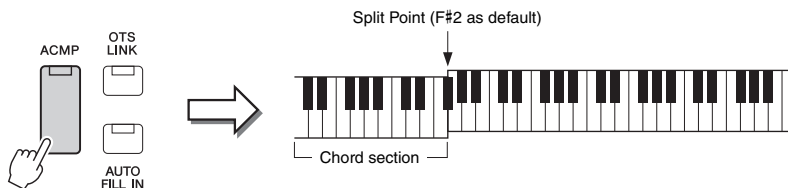

At the same time, the specific left-hand section of the keyboard can be used as the Chord section, and chords played in this section are automatically detected and used as a basis for fully automatic accompaniment with the selected Style.

4 If necessary, try out the selected Style.

Press the STYLE CONTROL [] (SYNC START) button, and then play chords with your left hand.

To stop Style Playback, press the STYLE CONTROL [ / ] (START/STOP) button.

NOTE

For more details on operating Style playback, refer to page 58.

Style Characteristics

The particular type of Style is indicated the upper left of the Style name in the Style Selection display. The defining characteristics of these Styles and their performance advantages are described below.

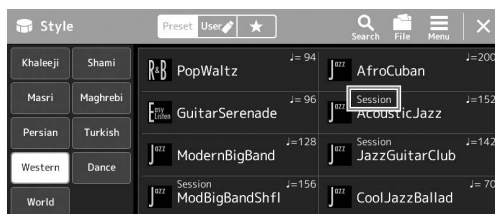

- **Session:** These Styles provide even greater realism and authentic backing by mixing in original chord types and changes, as well as special riffs with chord changes, with the Main sections. These have been programmed to add “spice” and a professional touch to your performances of certain songs and in certain genres. Keep in mind, however, that the Styles may not necessarily be appropriate—or even harmonically correct—for all songs and for all chord playing. In some cases for example, playing a simple major triad for a country song may result in a “jazzy” seventh chord, or playing an on-bass chord may result in inappropriate or unexpected accompaniment.
- **Free Play:** These Styles are characterized by rubato performance. You can perform freely with remarkably expressive accompaniment, without being constrained by a strict tempo.
- **DJ:** These contain their own special chord progressions, so you can add chord changes to your performance simply by changing the root key. The Multi Pad (page 53) data in the “DJ Phrase” category are specially created for these Styles. You can call up the suitable Multi Pads by using the One Touch Setting function (page 43).

NOTE

You cannot specify the chord type, such as major and minor, when using the DJ Styles.

For the Preset Style List, refer to the Data List on the website.

A Style generally consists of eight parts (channels): rhythm, bass, etc. You can add variations and change the feeling of a Style by selectively turning channels on/off or by changing the Voices (page 85).

In some particular Styles, some sections consist of only rhythm parts to showcase their musical characteristics. For details, refer to the Data List on the website.

Style File Compatibility

This instrument uses the SFF GE file format (page 8) and can play back existing SFF files; however, they will be saved in the SFF GE format when the file is saved (or loaded) in this instrument. Keep in mind that the saved file can only be played back on instruments that are compatible with the SFF GE format.

Adjusting the tempo

The TEMPO [-] and [+] buttons let you change the playback tempo of the Metronome, Style and MIDI Song. The tempo of the Style and MIDI Song can also be adjusted via the [RESET/TAP TEMPO] button.

● TEMPO [-]/[+] buttons

Press the TEMPO [-] or [+] button to call up the Tempo pop-up display. Use the TEMPO [-]/[+] buttons to decrease or increase the tempo over a range of 5–500 beats per minute. Holding down either button changes the value continuously. Pressing both TEMPO [-] and [+] buttons calls up the default tempo of the last selected Style or Song.

NOTE

If you want to adjust the tempo of an Audio Song, use the Time Stretch function on page 72.

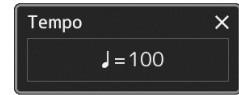

● [RESET/TAP TEMPO] button

When Style and MIDI Song are stopped, tapping the [RESET/TAP TEMPO] button (four times for a 4/4 time signature) starts playback of the rhythm part of the Style at the tempo you tapped.

During playback of a MIDI Song, you can change the tempo by tapping the [RESET/TAP TEMPO] button twice at the desired tempo.

During playback of a Style, you can rewind to the top of the section (“reset” the playback position, for stutter repeat effects) by tapping the [RESET/TAP TEMPO] button. This is called “Style Section Reset.”

NOTE

This button can also be set to change the tempo during Style playback, instead of Section Reset. The setting is made on the display called up via [MENU] → [Metronome] → [Tap Tempo]. For details, refer to the Reference Manual on the website.

Changing the Chord Fingering type

By changing the Chord Fingering type, you can automatically produce appropriate accompaniment even if you don't press all of the notes which comprise a chord. Chord fingering type can be changed via the Split Point/Fingering window:

[MENU] → [Split & Fingering].

The following types can be selected:

● Single Finger

This method lets you easily play chords in the accompaniment range of the keyboard using only one, two or three fingers.



Major chord

Press the root key only.



Minor chord

Simultaneously press the root key and a black key to its left.



Seventh chord

Simultaneously press the root key and a white key to its left.



Minor seventh chord

Simultaneously press the root key and both a white and black key to its left.

● Fingered

This lets you finger your own chords on the chord section of the keyboard, while the instrument supplies appropriately orchestrated rhythm, bass, and chord accompaniment in the selected Style. The Fingered type recognizes the various chord types which are listed on the Data List on the website (page 9), and can be looked up using the Chord Tutor function called up via [MENU] → [Chord Tutor].

● AI Full Keyboard

This lets you play just about anything, anywhere on the keyboard using both hands—like conventional playing of a piano—and still have appropriate accompaniment. You don't have to worry about specific ways to play/indicate the chords. (Depending on the song arrangement, AI Full Keyboard may not always produce appropriate accompaniment.)

NOTE

When the chord detection area is set to “Upper” (page 47), only “Fingered*” is available.

For other types, refer to the Reference Manual on the website (page 9).

NOTE

In the case of a specific fingering type (Fingered, Fingered On Bass, AI Fingered), you can create a state in which no chord is input by entering a special chord named “Cancel.” This is called as “Chord Cancel.” For more information on entering chords including “Cancel,” refer to the “Chord Types Recognized in the Fingered Mode” in the Reference Manual on the website.

Optimum Panel Settings for the Current Style (One Touch Setting)

One Touch Setting is a powerful and convenient feature that automatically calls up the most appropriate panel settings (Voices, effects, etc.) for the currently selected Style, with the touch of a single button. If you've already decided which Style you wish to use, you can have One Touch Setting automatically select the appropriate Voice for you.

1 Select the desired Style (steps 1–2 on page 40).

2 Press one of the ONE TOUCH SETTING [1]–[4] buttons.

Not only does this instantly call up all the settings (Voices, effects, etc.) that match and are most commonly used with the current Style, it also automatically turns on ACMP and SYNC START, so that you can immediately start playing the Style.

Confirming the One Touch Setting Contents

In the Style Selection display, touch  (Menu) followed by [Style Information] to call up the Information window that shows what Voices are assigned to the ONE TOUCH SETTING [1]–[4] buttons for the current Style. You can call up the desired settings also by touching one of the One Touch Settings numbers 1–4 directly on the Information window.

3 As soon as you play a chord with your left hand, the selected Style starts.

Each Style has four One Touch Setting setups. Press any other of the ONE TOUCH SETTING [1]–[4] buttons to try out other setups.

NOTE

For information on panel settings that are called up by One Touch Setting, refer to the OTS section of "Parameter Chart" in the Data List on the website (page 9).

NOTE

You can automatically have the One Touch Settings change when you select a Main section (A–D) of the selected Style. For details, refer to "OTS LINK" (page 59).

Setting up Keyboard Parts

There are four keyboard parts for your manual performance: LEFT, RIGHT 1, RIGHT 2 and RIGHT 3, and each part has one Voice. You can combine these parts by using the PART ON/OFF buttons to create luscious instrument textures and convenient performance combinations.

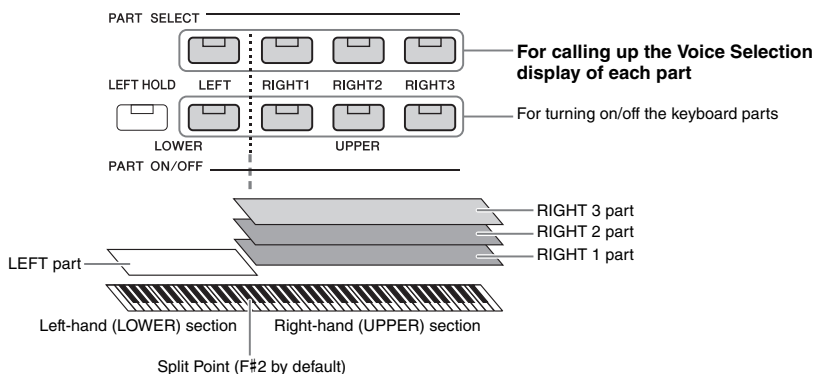

Creating combinations of keyboard parts (Layer, Split)

● To play one single Voice over the entire keyboard:

Turn on the RIGHT 1, 2 or 3 part. Make sure the LEFT part is turned off.

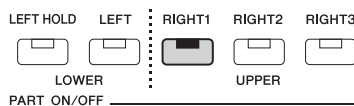

● To play two or three different Voices simultaneously (Layer):

Turn on two or more parts from RIGHT 1, 2 and 3.

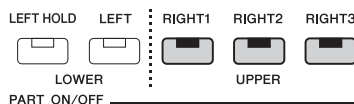

● To play different Voices in the right- and left-hand sections of the keyboard (Split):

Turn on the LEFT part and at least one of the RIGHT 1–3 parts. The F#2 and lower keys are used for the LEFT part while the upper keys (excluding F#2) are used for the RIGHT 1, 2 and 3 parts. The key which divides the keyboard into the left-hand and right-hand sections is referred to as the “Split Point.”

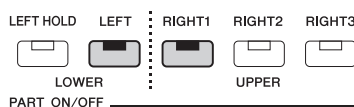

Turning each keyboard part on/off from the display

You can also turn parts on/off via the Home display, or the Voice Part Setup display. For details, see “Home Display” (page 26), or “Voice Part Setup Display” (Reference Manual on the web site).

Holding the LEFT part Voice (Left Hold)

By turning on the PART ON/OFF [LEFT HOLD] button when the LEFT part is ON, the LEFT part Voice is held even when the keys are released.

Non-decaying Voices such as strings are held continuously, while decay-type Voices such as piano decay more slowly (as if the sustain pedal has been pressed). This function is convenient when used along with Style playback since the sound of the chords matching Style playback are maintained.

To stop the LEFT part Voice from sounding, stop Style or Song playback, or turn the [LEFT HOLD] button off.

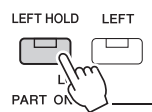

Setting the Split Point

The key which divides the keyboard into two areas is referred to as “Split Point.” There are three types of Split Point: Split Point (Style), Split Point (Left), and Split Point (Right 3). You can set them individually (as shown).

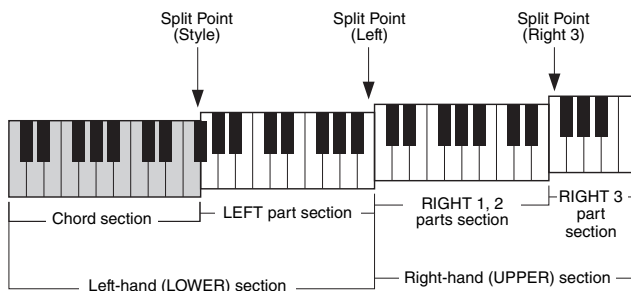

- **Split Point (Style):**Divides the left-hand (LOWER) section into the Chord section and the LEFT part section.
- **Split Point (Left):**Divides the keyboard into the left-hand (LOWER) section and the right-hand (UPPER) section.
- **Split Point (Right 3):**Divides the right-hand (UPPER) section into the RIGHT 1, 2 parts section and the RIGHT 3 part section.

1 Call up the Split Point/Fingering window.

[MENU] → [Split & Fingering]

2 Set the Split Point.

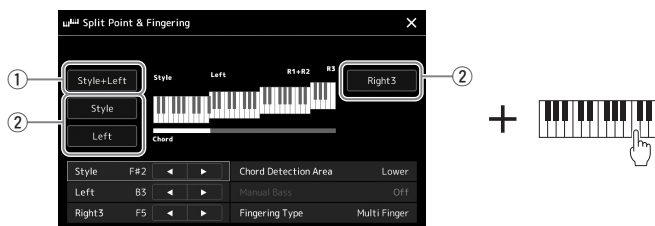

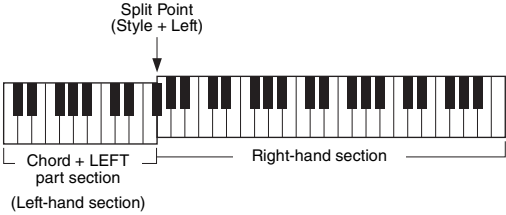
<p>① Split Point (Style + Left)</p>	<p>Sets Split Point (Style) and Split Point (Left) to the same note. In this case, the Chord Section and the LEFT part section occupy the same area.</p> <p>Specify the Split Point directly from the keyboard by simultaneously holding [Style + Left] on the display and pressing the desired key on the keyboard.</p> 
<p>② Split Point (Style, Left, Right 3)</p>	<p>Sets each Split Point individually.</p> <p>Specify the Split Point directly from the keyboard by simultaneously holding the corresponding item on the display and pressing the desired key on the keyboard.</p>

You can also specify each Split Point by note name, touching the [◀]/[▶] controls. Split Point (Style) is indicated by “Style,” Split Point (Left) is indicated by “Left,” and Split Point (Right 3) is indicated by “Right 3.”

 **NOTE**

Once you have touched [◀]/[▶], the Split Point type you are controlling is focused (corresponding indicator is colored). In this condition, you can change the value of the focused Split Point type by rotating the Data dial.

 **NOTE**

Split Point (Left) cannot be set lower than Split Point (Style), and Split Point (Right 3) cannot be set lower than Split Point (Left).

Specifying chords with your right hand for Style playback

By changing the Chord Detection area from the left-hand section to the right-hand section, you can play a bass line with your left hand while using your right hand to play chords for controlling Style playback.

1 Call up the Split Point/Fingering window.

[MENU] → [Split & Fingering]

2 Make the necessary settings by touching the display.



<p>Chord Detection Area</p>	<p>Select "Upper." The Chord section is set to the right of the left Split Point. Fingering type is set to "Fingered*" automatically.</p> <p>NOTE</p> <ul style="list-style-type: none"> • "Fingered*" is basically same as "Fingered," except that "1+5," "1+8" and Chord Cancel are not available. • For information about when the "Chord Detection Area" is set to "Lower," refer to "Setting the Split Point" (page 45).
<p>Manual Bass</p>	<p>When this is set to "On," the bass part of the current Style is muted and the Voice of the muted bass part is assigned to the left part.</p> <p>NOTE</p> <ul style="list-style-type: none"> • Manual Bass is set to "On" automatically by the default settings when you select "Upper" in the Chord Detection Area above. • This parameter is available only when the "Chord Detection Area" is set to "Upper."

Selecting a Voice for Each Keyboard Part

1 Press the PART SELECT button corresponding to the desired part.

The Voice Selection display (for the desired part) appears.

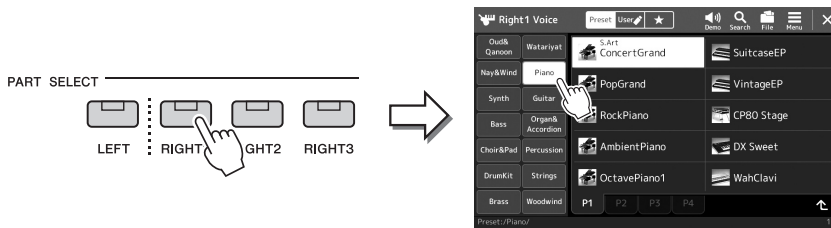

NOTE

You can also call up the Voice Selection display via the Home display (page 26) or the Voice Part Setup display (Reference Manual on the web site).

2 Touch the desired Voice.

You can also select the sub category of the Voice by pressing one of the VOICE category selection buttons.

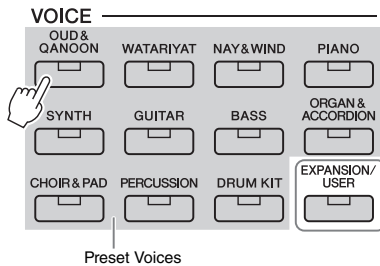

• **Expansion Voices**
Voices additionally installed (page 100).

• **User Voices**
Voices created with the Voice Set function (refer to the Reference Manual on the website), or Voices copied to the User drive (page 34).

NOTE

For basic operations of the Voice Selection display, refer to "File Selection Display" (page 28).

To hear the characteristics of the Voices:

Touch (Demo) to start demo playback of the selected Voice. Touch (Demo) again to stop playback.

3 If necessary, try out the selected Voice.

Make sure that the desired keyboard part is turned on, and play the keyboard.

Voice Characteristics

The Voice type and its defining characteristics are indicated above the Voice name. There are various Voice characteristics; however, only the following ones are covered here. For detailed explanations, refer to the Reference Manual on the website (page 9).

• S.Art (Super Articulation) Voices (page 63)

Lets you create subtle, very realistic expressive nuances, simply by how you play or by pressing a foot pedal connected to the FOOT PEDAL [2] jack.

• Organ Flutes Voices (page 49)

Lets you recreate all of the classic organ sounds by adjusting the flute footage levels and the percussive sounds, just like on conventional organs.

• Drums/SFX Voices

These let you play various drums and percussion instruments or SFX (sound effects) sounds on the keyboard, collected together in what are called Drum/SFX kits. For details, see the "Drum/SFX Kit List" of the Data List on the website.



Creating Original Organ Flutes Voices

This instrument uses advanced digital technology to recreate the legendary sound of vintage organs. Just as on a traditional electronic organ, you can create your own sound by increasing and decreasing the levels of the flute footages. The created Voice can be saved for future recall.

NOTE

The term “footage” is a reference to the sound generation of traditional pipe organs, in which the sound is produced by pipes of different lengths (in feet).

1 On the Voice Selection display, select the desired Organ Flutes Voice.

Touch the [Organ] in the sub categories, and then select the desired Organ Flutes Voice.

2 Return to the Home display, and then touch  (Organ Flutes) located at the lower right of the Voice name to call up the Organ Flutes Voice Edit display.

3 Slide the Footage levers to adjust the footage settings.

The footage settings determine the basic sound of the Organ Flutes.

NOTE

- The available parameters differ depending on the Organ type.
- You can also make Effects and EQ settings. For details, refer to the Reference Manual on the website (page 9).

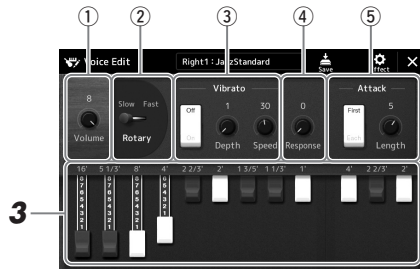

You can also change other settings here, such as Rotary Speaker and Vibrato.

①	Volume	Determines the volume of the entire Organ Flutes sound.
②	Rotary Speaker	Alternately switches between the slow and fast rotary speaker speeds. This parameter is available only when an effect which contains “Rotary” or “Rot” in its name is applied.
③	Vibrato	Turns the vibrato on or off, and allows you to adjust the vibrato depth and vibrato speed.
④	Response	Adjusts the response speed of both the Attack and Release portions of the sound.
⑤	Attack	Switches between two different Attack modes: First and Each, and determines the length of the Attack sound.

4 Touch  (Save) and save the created Organ Voice.

For instructions on saving, refer to “File Management” (page 33).

NOTICE

The settings will be lost if you select another Voice or turn the power to the instrument off without executing the Save operation.

Setting up Keyboard Harmony/Arpeggio

You can apply the Keyboard Harmony or Arpeggio features to enhance or change the sound of the right-hand parts (RIGHT 1–3). Keyboard Harmony applies performance effects such as harmony (duet, trio, etc.), echo, tremolo and trill to the notes played in the right-hand section. The Arpeggio function lets you play arpeggios (broken chords) by simply pressing the notes of the chord. For example, you could play the notes C, E and G to trigger interesting and rhythmically dynamic phrases. This feature can be used for music production as well as live performance.

NOTE

When you select another Voice for the RIGHT 1 part, the Keyboard Harmony/Arpeggio type is automatically set to the type which is memorized as the Voice Set. For details on the Voice Set function, refer to the Reference Manual on the website.

Using Keyboard Harmony

1 Call up the operation display.

[MENU] → [Kbd Harmony/Arp]

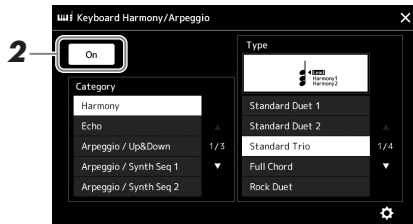

2 Set the Keyboard Harmony/Arpeggio function to “On.”

When this is set to “On,” Keyboard Harmony is applied to your keyboard performance automatically.

3 Touch to select the desired category, “Harmony” or “Echo.”

4 Touch the desired Harmony or Echo type.

Touching  (detailed settings) calls up the detailed settings popup window. For more information, refer to the Reference Manual on the web site.

5 Play the keyboard.

The effect selected in step 4 is applied to the right-hand melody.

NOTE

You can also set the function to “On” by turning the [HARMONY/ARPEGGIO] button on.

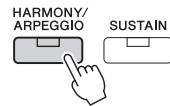

To turn off the effect, turn the [HARMONY/ARPEGGIO] button off.

■ Keyboard Harmony category types (Harmony/Echo)

● Harmony Category

Standard Duet—Strum

These types apply the harmony effect to notes played in the right-hand section of the keyboard according to the chord specified in the left-hand section of the keyboard. (Note that the “1+5” and “Octave” settings are not affected by the chord.)

- When the [ACMP] button is on and the LEFT part is off:

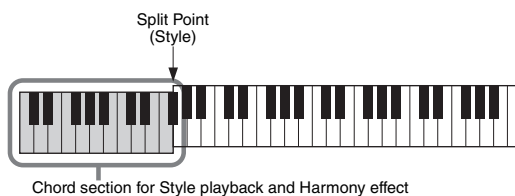

NOTE

For details on the Split Point, refer to page 45.

- When the [ACMP] button is off and the LEFT part is on:

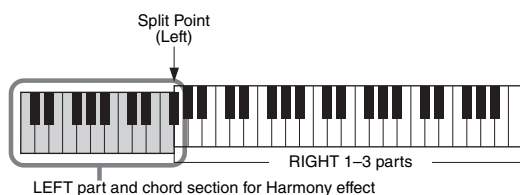

- When both the [ACMP] button and the LEFT part are on:

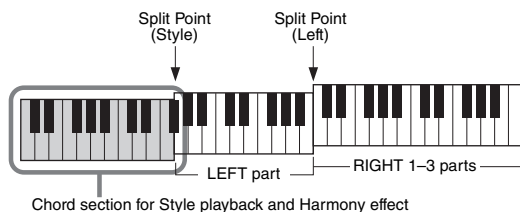

Multi Assign

The Multi Assign effect automatically assigns the notes of chords you play on the right-hand section of the keyboard to separate parts (Voices). For example, if you play a three-note chord, the first note you press is played by the RIGHT 1 Voice, the second by the RIGHT 2 Voice, and the third by the RIGHT 3 Voice. The Multi Assign effect is not affected by the [ACMP] and LEFT part on/off status.

● Echo Category (Echo, Tremolo, Trill)

The Echo, Tremolo or Trill effect is applied to the note played in the right-hand section of the keyboard in time with the currently set tempo, regardless of the [ACMP] and the LEFT part on/off status. Keep in mind that Trill works only when you hold down two notes on the keyboard simultaneously (or the last two notes, if more than two notes are held), and it plays those notes alternately.

Using Arpeggio

1 Call up the operation display.

[MENU] → [Kbd Harmony/Arp]

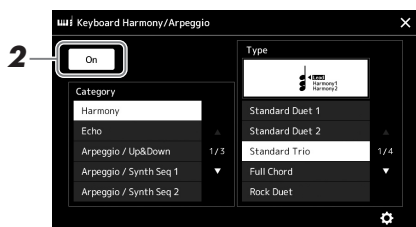

2 Set the Keyboard Harmony/Arpeggio function to “On.”

When this is set to “On,” Keyboard Harmony is applied to your keyboard performance automatically.

3 Touch to select a category other than “Harmony” or “Echo.”

4 Touch the desired Arpeggio type.

Touching  (detailed settings) calls up the detailed settings popup window. For more information, refer to the Reference Manual on the web site.

NOTE

You can also set the function to “On” by turning the [HARMONY/ARPEGGIO] button on.

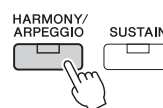

5 Play a note or notes to trigger the Arpeggio.

The arpeggiated phrase differs depending on the notes played.

To turn off the effect, turn the [HARMONY/ARPEGGIO] button off.

NOTE

- By using the Arpeggio Quantize function, Arpeggio playback can be synchronized with Song/Style playback, allowing any slight imperfections in the timing to be corrected. This can be set in the display: [MENU] → [Voice Setting] → [Arpeggio].
- Arpeggio playback can be continued even after the note has been released, by assigning the Arpeggio Hold function to the footswitch. For instructions, refer to page 57.

Setting up Multi Pads

Selecting Multi Pads

- 1 Press the **MULTI PAD CONTROL [SELECT]** button to call up the Multi Pad Bank Selection display.

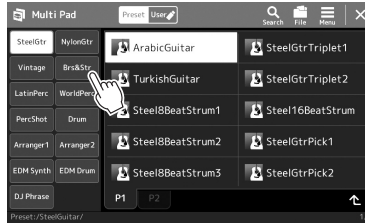
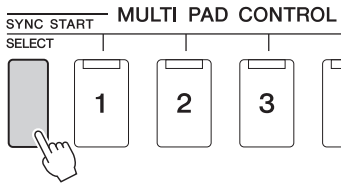

NOTE

You can also call up the Multi Pad Selection display via the Home display (page 26).

- 2 Touch the desired Multi Pad Bank.

- 3 If desired, try out the selected Multi Pad(s).

Simply press the MULTI PAD CONTROL [1]–[4] buttons to start playback of the corresponding phrase. To stop playback, press the [STOP] button.

For more information on Multi Pad playback control, refer to “Controlling Multi Pad Playback” (page 64).

NOTE

For basic operations of the Multi Pad Selection display, refer to “File Selection Display” (page 28).

Creating and Editing Multi Pads

You can create your original Multi Pads in one of three ways:

- Recording new phrases
- Editing existing Multi Pad phrases
- Linking with audio files (Audio Link Multi Pad)

Also, you can make your original Multi Pad Bank by managing each Multi Pad. For details, refer to the Reference Manual on the web site (page 9).

Memorizing Original Panel Settings to One Touch Setting

You can memorize your original panel settings (mainly Style, Voices, and Multi Pads) to a One Touch Setting (OTS). The newly created One Touch Setting will be saved in the User drive or a USB flash drive as a Style, and you can call up the One Touch Setting as a part of the Style.

NOTE

For information on which panel settings are memorized to One Touch Setting, refer to "Parameter Chart" in the Data List on the website (page 9).

- 1** Select the desired Style to memorize your One Touch Setting.
- 2** Make the desired panel settings, such as those for Voices and Effects.
- 3** Press the [MEMORY] button in the REGISTRATION MEMORY section.

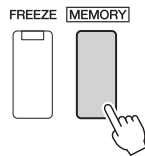

A message appears. However, you do not need to make any settings here, since the On/Off settings in this display do not affect the One Touch Setting function.

- 4** Press the desired ONE TOUCH SETTING [1]–[4] button to which you wish to memorize your panel settings.

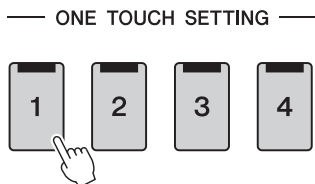

A message appears prompting you to save the panel settings at this time. To go on and memorize various panel settings to other buttons, touch [No], and then repeat steps 2–4 as necessary, finally saving all your new settings in Step 5 below.

- 5** Touch [Yes] to call up the Style Selection display for saving your data, and then save the current settings as a User Style.

For instructions on saving, refer to "File Management" (page 33).

NOTE

For OTS buttons to which your panel settings have not been memorized, the OTS settings of the original Style will be maintained.

NOTICE

The memorized One Touch Setting will be lost if you change the Style or turn the power off without carrying out the Save operation.

Changing the Pitch of the Keyboard

Transposing the pitch in semitones (TRANPOSE [-]/[+] buttons)

The TRANPOSE [-]/[+] buttons transpose the overall pitch of the instrument (the keyboard sound, Style playback, MIDI Song playback, and so on) in semitone steps (from -12 to 12). To instantly reset the transpose value to 0, press the [-] and [+] buttons simultaneously.

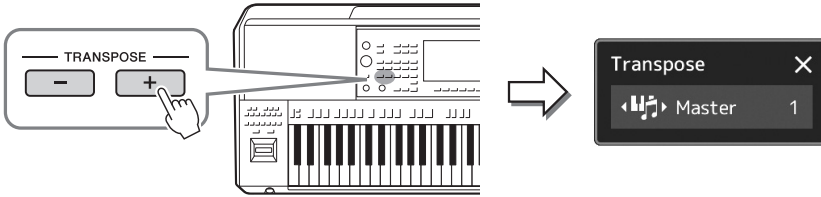

NOTE

- If you want to transpose the pitch of the Audio Song, use the Pitch Shift parameter on page 72.
- The Transpose functions do not affect the Drum Kit or SFX Kit Voices.

You can independently select the part to be transposed as desired. Touch the Transpose pop-up several times until the desired part appears, and then use the TRANPOSE [-]/[+] buttons to transpose it.

NOTE

Transpose can be done on the display also via [MENU] → [Transpose]. For details, refer to the Reference Manual on the website.

Master	Transposes the pitch of the entire sound, with the exception of the Audio Song and input sound from the [MIC/GUITAR INPUT] or the [AUX IN] jacks.
Keyboard	Transposes the keyboard pitch including the chord root for triggering Style Playback.
Song	Transposes the pitch of the MIDI Song.

Fine Tuning the Pitch

By default, the pitch of the entire instrument is set to 440.0 Hz according to equal temperament. This setup can be changed from the display called up via [MENU] → [Master Tune]. For details, refer to the Reference Manual on the website.

Transposing the pitch in octaves (UPPER OCTAVE [-]/[+] buttons)

The UPPER OCTAVE [-]/[+] buttons allow you to shift the pitch of the Right 1–3 parts up or down in octave units. To instantly reset the octave value to 0, press the [-] and [+] buttons simultaneously.

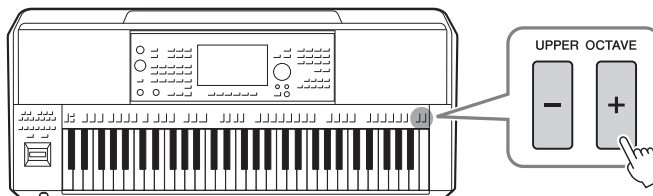

Setting up Assignable Controllers

You can assign parameters and functions to the LIVE CONTROL knobs, the LIVE CONTROL joystick, the [STYLE TEMPO LOCK/ASSIGNABLE] button, or optional footswitches for quick operations and expressive control during your keyboard performance. The setup of assignable controllers is stored/recalled from the registration memory so you can change them all together at once.

Selecting the Assign Types of the LIVE CONTROL knobs

Each setup of assigned parameters for knobs is called “Knob Assign Type.” There are three Knob Assign Types (1–3) and they can be switched in sequence by pressing the LIVE CONTROL [ASSIGN] button. The selected Assign Types for knobs will be reset when the power is turned off; however, these can be conveniently saved to Registration Memory (page 89).

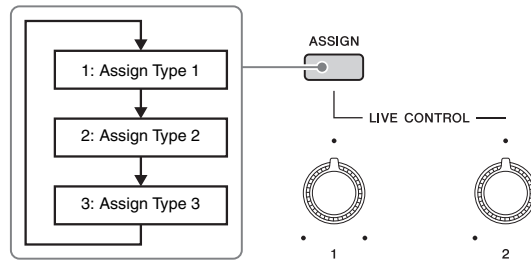

Editing the Assign Type of the knobs

Knob Assign Types 1–3 can be edited in the Edit display which is called up via [MENU] → [Live Control]. For details of editable items, refer to the Reference Manual on the website.

Selecting the Assign Types of the LIVE CONTROL joystick

Each setup of assigned parameters for the joystick is called “Joystick Assign Type.” There are three Joystick Assign Types (1–3) and they can be switched in sequence by pressing the ASSIGNABLE [D] button by default. The selected Assign Types for the joystick will be reset when the power is turned off; however, these can be conveniently saved to Registration Memory (page 89).

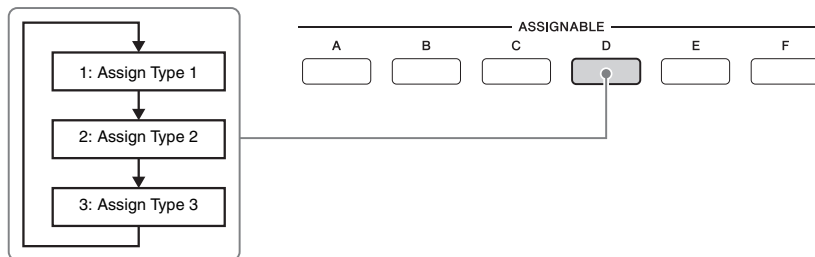

Editing the Assign Type of the joystick

Joystick Assign Types 1–3 can be edited in the Edit display which is called up as follows: [MENU] → [Live Control]. For details of editable items, refer to the Reference Manual on the website.

Assigning functions to the assignable buttons

Various functions can be assigned to the ASSIGNABLE [A]–[F] buttons and the [STYLE TEMPO LOCK/ASSIGNABLE] button.

- 1 To call up the Edit display, touch [MENU] → [Assignable].

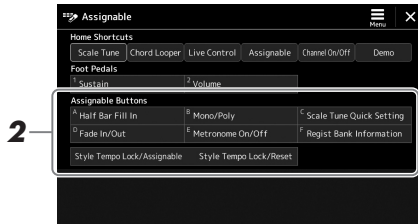

- 2 Double-tap (touch twice) the desired item on the “Assignable Buttons” area (shown above).

The function selection pop-up window appears.

- 3 Touch the desired function.

NOTE

There are some differences between the ASSIGNABLE [A]–[F] buttons and the [STYLE TEMPO LOCK/ASSIGNABLE] button on which functions can be assigned. For details on assignable functions, refer to the Reference Manual on the website.

Assigning functions to footswitches/foot controllers

You can assign various functions to optional footswitches/foot controllers.

- 1 To call up the Edit display, touch [MENU] → [Assignable].

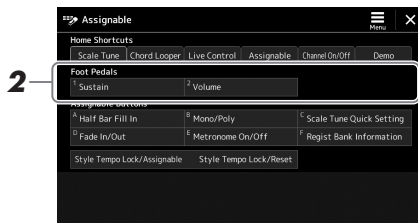

- 2 Double-tap (touch twice) the desired item in the “Foot Pedals” area (shown above).

The function selection pop-up window appears.

- 3 Touch the desired function.

NOTE

- For details on assignable parameters and functions, refer to the Reference Manual on the website.
- For connecting footswitches/foot controllers, refer to “Connecting Footswitches/Foot Controllers” (page 107).

Playing with Styles—Operations While Performing

If you've made all desired settings for a single song (in the previous sections), now you're ready to play the keyboard. This section mainly explains the various Style-related operations you'll use during your keyboard performance: Style playback, applying expressive effects, and Multi Pad playback.

Operating Style Playback

Starting and stopping Style playback

● [START/STOP] button

Starts playback of the rhythm part of the current Style. To stop playback, press the button again.



Playing back both rhythm and auto accompaniment (ACMP)

If the [ACMP] button is turned on, both the rhythm part and auto accompaniment can be played back when playing chords in the chord section during Style playback.



● [SYNC START] button

This puts the Style playback in "standby." The Style starts playing back when you press any note on the keyboard (when [ACMP] is off) or you play a chord with your left hand (when [ACMP] is on). While a Style is playing back, pressing this button stops the Style and puts playback in standby.



● [SYNC STOP] button

You can start and stop the Style any time you want by simply playing or releasing the keys in the chord section of the keyboard. Make sure that the [ACMP] button is on, press the [SYNC STOP] button, and then play the keyboard.



NOTE

When the Fingering type (page 42) is set to "Full Keyboard" or "All Full Keyboard," Sync Stop cannot be turned on.

● INTRO [I]–[III] buttons

The instrument features three different Intro sections that let you add an introduction before starting the Style playback. After pressing one of the INTRO [I]–[III] buttons, start playback of the Style. When the Intro finishes playing, the Style playback automatically shifts to the Main section.

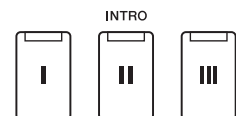

● ENDING/rit. [I]–[III] buttons

The instrument features three different Ending sections that let you add an ending before stopping Style playback. When you press one of the ENDING [I]–[III] buttons while Style is playing back, the Style will automatically stop after the ending is played. You can have the ending gradually slow down (ritardando) by pressing the same ENDING button once again, while the ending is playing.

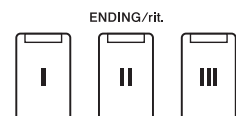

Fading In/Out

The Fade In/Out function produces smooth fade-ins and fade-outs when starting/stopping the playback of a Style or Song. You can assign this function to the assignable buttons and foot pedals.

NOTE

For information on assigning functions to each controller, refer to “Setting up Assignable Controllers” (page 56) and “Setting the Functions or Shortcuts to the ASSIGNABLE Buttons” (page 97).

- **To start playback with a fade-in:**

When playback is stopped, press the button/pedal to which this function has been assigned. Then press the [START/STOP] button for Style (or the [▶/⏸] (PLAY/PAUSE) button for MIDI Song).

- **To stop playback with a fade-out:**

During playback, press the button/pedal to which this function has been assigned.

Changing pattern variations (Sections) during Style playback

Each Style features four different Main sections, four Fill-in sections and a Break section. By using these sections effectively, you can easily make your performance sound more dynamic and professional. The section can be freely changed while the Style is playing back.

- **MAIN VARIATION [A]–[D] buttons**

Press one of the MAIN VARIATION [A]–[D] buttons to select the desired Main section (the button lights in red). Each is an accompaniment pattern of a few measures or more and it plays indefinitely. Pressing the selected MAIN VARIATION button again plays an appropriate fill-in pattern to spice up the rhythm and break the repetition. After the fill-in finishes playing, it leads smoothly into the Main section.

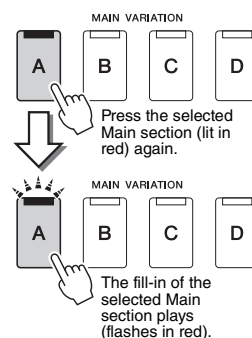

AUTO FILL IN function

When the [AUTO FILL IN] button is turned on, pressing any of the MAIN VARIATION [A]–[D] buttons as you play automatically plays a fill-in section for a smooth, dynamic transition into the next (or same) section.

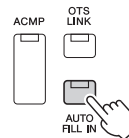

Style Section Reset

During playback of a Style, you can rewind to the top of the section (“reset” the playback position, for stutter repeat effects) by pressing the [RESET/TAP TEMPO] button (page 42).

Style Section Change Timing

You can choose behavior when Style sections are changed. For details, refer to the Reference Manual on the website.

Automatically changing One Touch Settings with the Main sections (OTS LINK)

The convenient OTS (One Touch Setting) Link function lets you automatically have One Touch Settings change when you select a different Main section (A–D). The Main sections A, B, C and D correspond to One Touch Settings 1, 2, 3 and 4 respectively. To use the OTS Link function, turn the [OTS LINK] button on.

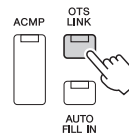

NOTE

You can change the timing in which the One Touch Settings change with the MAIN VARIATION [A]–[D] changes. To do this, call up the display via [MENU] → [Style Setting] → [Setting], then set the OTS Link Timing parameter. For details, refer to the Reference Manual on the website (page 9)

● [BREAK] button

This lets you add dynamic breaks in the rhythm of the accompaniment. Press the [BREAK] button during Style playback. When the one-measure Break pattern finishes playing, Style playback automatically shifts to the Main section.



About the lamp status of the section buttons (INTRO, MAIN VARIATION, BREAK, ENDING)

- **Orange:** The section is currently selected.
- **Orange (flashing):** The section will be played next, following the currently selected section.
 - * The MAIN VARIATION [A]–[D] button lamps also flash in orange when the fill-in is playing.
- **Blue:** The section contains data but is not currently selected.
- **Off:** The section contains no data and cannot be played.

Recording and Playing Back a Chord Sequence—Chord Looper

While playing back a Style, you usually specify chords with your left hand. However, with the convenient Chord Looper function, you can record a sequence of the chords and play it back in a loop. For example, if you record a “C → F → G → C” chord progression, Style playback will continue automatically with the chords “C → F → G → C → C → F → G → C → ...” Since the chords play back in a loop, you don’t need to repeat the chord pattern manually anymore—letting you focus on your performance and other operations.

Loop playback a chord sequence while playing back the Style

You can record desired chord sequence instantly and loop it.

- 1 While playing back a Style, press the CHORD LOOPER [REC/STOP] button.**

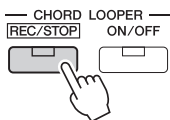

NOTE

When the [REC/STOP] is turned on, the [ACMP] button is turned on automatically.

The [REC/STOP] button flashes to indicate the Chord Looper function is standby to record.

On the next measure of the Style, the [REC/STOP] button is turned on and the recording starts.

- 2 Enter the chords on the keyboard, according to the playback tempo of the Style.**



The chord sequence continues to be recorded until you stop recording in step 3.

3 Press the CHORD LOOPER [ON/OFF] button to stop recording and start loop playback of the chord sequence.

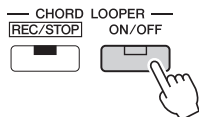

Recording stops, and the [ON/OFF] button flashes in orange and loop playback standby is entered.

On the next measure of the Style, the [ON/OFF] button lights in orange, and the chord sequence recorded in step 2 will be played back in loop.

4 Press the CHORD LOOPER [ON/OFF] button to stop loop playback.

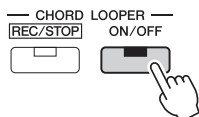

The playback of the chord sequence is stopped, and the Style will return to normal playback.

NOTE

While the chord sequence is played back, the [ACMP] button flashes, chord input from the keyboard is disabled, and the entire keyboard is only used for performance.

NOTE

- The [ON/OFF] button lights in blue to indicate the chord sequence has been recorded and loop playback stops.
- Pressing the [ON/OFF] button restarts loop playback of the chord sequence recorded on steps 1–3.

Advanced features of the Chord Looper function

You can start recording the chord sequence when Style playback is stopped, using SYNC START.

Also, you can save recorded chord sequences from the display called up via [MENU] → [Chord Looper].

- Up to eight chord sequences can be memorized.
- You can save each chord sequence as a file individually for future recall.

For details, refer to the Reference Manual on the website.

Expressively Controlling Your Performance

Using the Joystick

By default, by moving the joystick in a horizontal (X) or vertical (Y) direction, you can bend the pitches up or down, or apply modulation effects. Move the joystick to control the sound while playing the keyboard.

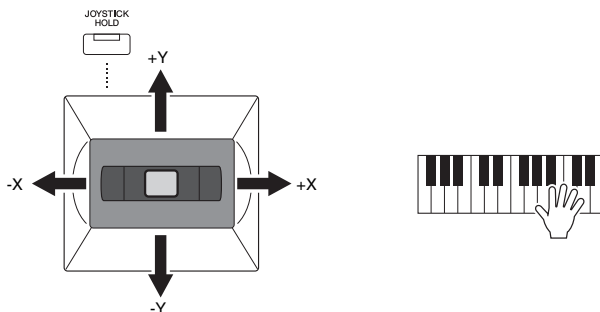

● X: Pitch Bend

Bends pitches up (by moving the joystick to the right) or down (by moving the joystick to the left) while playing the keyboard. This is applied to all keyboard parts (RIGHT 1–3 and LEFT).

● Y: Modulation

The Modulation function applies a vibrato effect to notes played on the keyboard. By default, this is applied to the keyboard parts RIGHT 1–3.

You can assign various parameters to control with the joystick. For details, refer to the Reference Manual on the website.

NOTE

The effects of the Pitch Bend and the Modulation may not be applied to the LEFT part during Style playback, depending on the Style setting.

Holding the values (JOYSTICK HOLD)

The Joystick is self-centering when released. However, you can hold the current values by pressing the [JOYSTICK HOLD] button.

- If the [JOYSTICK HOLD] button is turned on while the Joystick is moved, the values are fixed and held even after the Joystick is released. By default, only the value of the Y-axis is fixed and held. For details, refer to the Reference Manual on the website.
- If the [JOYSTICK HOLD] button is turned off, the held values are released.

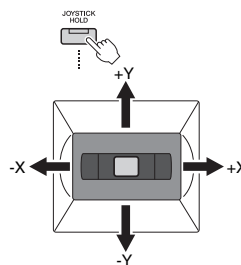

Applying sustain to the RIGHT 1–3 Voices

The [SUSTAIN] button turns the Sustain function on and off. When on, all notes played on the keyboard with the right-hand parts (RIGHT 1, 2, 3) have a longer sustain.

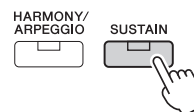

Playing and Controlling Super Articulation Voices

The word “articulation” in music usually refers to the transition or continuity between notes. This is often reflected in specific performance techniques, such as staccato, legato and slur.

The Super Articulation Voices (S.Art Voices) enable you to create subtle, very realistic expressive nuances, simply by how you play. The Voice type (S.Art) is indicated above the name of Super Articulation Voices, on the Voice Selection display.

NOTE

The applied articulation effect differs depending on the selected Voice. For details, refer to the Data List on the website.

Automatic articulation effects of Super Articulation Voices

■ S.Art Voices

The S.Art Voices provide many benefits with great playability and expressive real-time control.

Example: Saxophone Voice

If you play a C note and then an adjacent D in a very legato way, you will hear the note change seamlessly, as though a saxophone player played it in a single breath.

Example: Concert Guitar Voice

If you play a C note and then the E just above in a very legato but firm way, the pitch slides up from C to E.

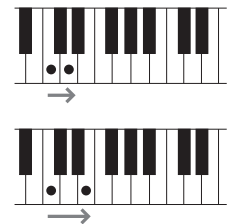

NOTE

You can also add articulation sounds manually by using the functions “Articulation 1–2” when the Voice has the corresponding sounds. These functions can be assigned to the ASSIGNABLE buttons, the [STYLE TEMPO LOCK/ASSIGNABLE] button, or the foot pedals (pages 57, 97).

Controlling Multi Pad Playback

Playing the Multi Pads

1 Press any of the MULTI PAD CONTROL [1]–[4] buttons to play a Multi Pad phrase.

The corresponding phrase for the button starts playing back in its entirety at the currently set tempo. You can play up to four Multi Pads at the same time.

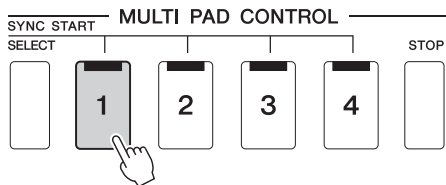

NOTE

- There are two types of Multi Pad data. Some types will play back once and stop when they reach the end. Others will be played back repeatedly (loop).
- Pressing the pad during its playback will stop playing and restart the phrase from the top.

2 Press the [STOP] button to stop playback of the Multi Pad(s).

If you want to stop a specific pad, simultaneously hold down the [STOP] button and press the pad(s) you wish to stop.

NOTE

- While the Style or MIDI Song is playing back, pressing the Multi Pad button starts playback at the top of the next measure. When the Style or MIDI Song is stopped, pressing the Multi Pad button starts playback immediately.
- While the Style or MIDI Song is playing back, pressing the STYLE CONTROL [START/STOP] or MIDI [▶/■] (PLAY/PAUSE) button also stops playback of the Multi Pad(s). While both the Style and MIDI Song are playing back, pressing the MIDI [▶/■] (PLAY/PAUSE) button stops playback of the Song, Style and Multi Pad(s). This behavior can be changed with settings on the Song Setting and Style Setting displays. For details, refer to the Reference Manual on the website.

About the lamp status of the MULTI PAD CONTROL [1]–[4] buttons

- **Blue:** Indicates that the corresponding pad contains data (phrase).
- **Orange:** Indicates that the corresponding pad is playing back.
- **Orange (flashing):** Indicates that the corresponding pad is in standby (Synchro Start; refer to page 65).
- **Off:** Indicates the corresponding pad contains no data and cannot be played.

Using Chord Match

When the [ACMP] or LEFT part is on, Multi Pad phrases automatically change the pitch to match the chord you play in the chord section.

Play the chord in the chord section before/after pressing any of the Multi Pads.

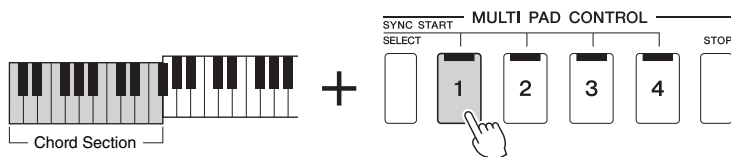

NOTE

Some Multi Pads are not affected by Chord Match.

Using the Multi Pad Synchro Start Function

You can also start Multi Pad playback by playing the keyboard or by starting Style playback.

1 While holding the MULTI PAD CONTROL [SELECT] button, press the desired button or buttons from [1]–[4].

The corresponding buttons flash in orange, indicating standby status.

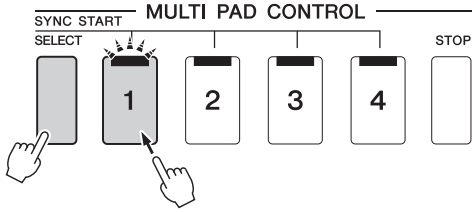

NOTE

To cancel the standby status of the selected Pad, carry out the same operation, or simply press the [STOP] button to cancel the status of all Pads.

2 Start playback of the Multi Pad.

- When [ACMP] is off, press any note, or play back a Style.
- When [ACMP] is on, play a chord in the chord section, or play back a Style.

If you enable standby for a Multi Pad during Style or Song playback, pressing any note (when [ACMP] is off) or playing a chord in the chord section (when [ACMP] is on) will start Multi Pad playback at the top of the next measure.

NOTE

When two or more Multi Pads are in standby status, pressing any one of them starts simultaneous playback of all of them.

This section explains how to set up for your singing performance with Songs, using Song selection.

As is the case in Chapter 1, the settings made in this section can be collectively stored in the Registration Memory as one song setting (page 89).

Setting Up Song Playback

Songs—MIDI and Audio

For this instrument, “Song” refers to MIDI or audio data which include preset songs, commercially available music files, etc. Not only can you playback a song and listen to it, but you can also play the keyboard or sing along with Song playback.

There are two kinds of Songs that can be recorded and played back on this instrument: MIDI Songs and Audio Songs.

● MIDI Songs

A MIDI Song is comprised of your keyboard performance information and is not a recording of the actual sound itself. The performance information refers to which keys are played, at what timing, and at what strength—just as in a musical score. Based on the recorded performance information, the tone generator (of the instrument, etc.) outputs the corresponding sound. Since MIDI Song data contains the information such as keyboard part and Voice, you can play more effectively by viewing the score, turning the particular part on or off, or changing Voices.

● Audio Songs

An Audio Song is a recording of the performed sound itself. This data is recorded in the same way as that used in recording cassette tapes, or with voice recorders, etc. Audio Songs can be played back on portable music players and many other devices, making it easy for you to let others hear what you have played.

If you want to play back a Song in a USB flash drive, connect the USB flash drive containing Song data to the [USB TO DEVICE] terminal beforehand.

NOTE

Before using a USB flash drive, be sure to read “Connecting USB Devices” on page 108.

Song File Compatibility

You can play back the following types of Songs.

- Preset Songs (MIDI Songs)
- Your own recorded Songs (for instructions on recording, see page 87)
- Commercially available Songs: MIDI files in SMF (Standard MIDI File) format, Audio files in WAV or MP3 format.

WAV 44.1 kHz sample rate, 16 bit resolution, stereo

MP3 44.1/48.0 kHz sample rate, 64–320 kbps bit rate or VBR, mono/stereo

NOTE

- For a general overview of MIDI and how you can effectively use it, refer to "MIDI Basics" on the website (page 9).
- For information on compatible MIDI formats, refer to page 8.

Switching Song playback modes

This instrument features two Song playback modes: Song Player and Song List. The Song Player mode simultaneously plays back both a MIDI Song and an Audio Song. The Song List mode plays back Songs continuously along with a previously created Song List.

1 Press the [PLAYER] button to call up the Song Playback display.

The Song Player function or Song List is displayed, depending on which you selected last time.

2 Touch the display or press the [PLAYER] button to switch the Song playback mode.

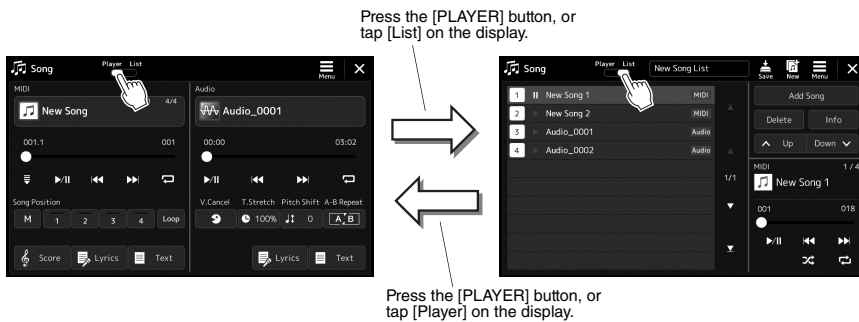

Selecting Songs (Song Player mode)

- 1 Press the [PLAYER] button to call up the Song Playback display. Make sure that Song Player mode is selected.

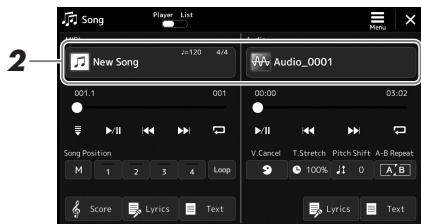

- 2 Touch the Song name in the MIDI or Audio area.

The Song Selection display for the corresponding Song type (MIDI or Audio) appears.

- 3 Select the desired Song.

Viewing Audio information

When an Audio Song is selected on the Song Selection display, touching  (Menu) then [Audio Information] calls up the information window.

For detailed playback operations, refer to page 70.

NOTE

- For basic operations of the Song Selection display, refer to "File Selection Display" (page 28).
- You can call up the display of Song playback related settings, via  (Menu) → [Song Setting].
- You can adjust the volume balance between MIDI Song playback and Audio Song playback, using the LIVE CONTROL knob/joystick to which "MIDI/Audio Song Balance" has been assigned. For details in assigning the LIVE CONTROL knob function, refer to the Reference Manual on the website.

Selecting Songs (Song List mode)

- 1** Press the [SONG] button to call up the Song Playback display. Make sure that Song List mode is selected.

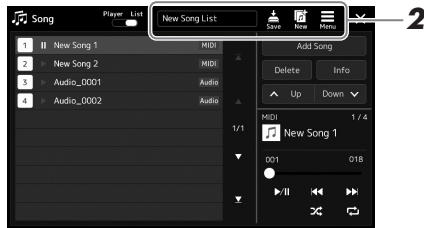

2 Prepare a Song List

● When creating a new Song List

Touching  (New) on the display allows you to create a new Song List.

For details on how to edit the Song List, refer to the Reference Manual on the website.

● When selecting an existing Song List

2-1 Call up the Song List File Selection display by touching the Song List name.

2-2 Touch the desired Song List file.

3 Touch the desired Song from the selected Song List.

The selected Song is highlighted.

For detailed playback controls, refer to page 70.

For information on controlling continuous playback of the Songs on the list, refer to the Reference Manual on the website.

Singing with Song Playback—Operations While Performing

This section explains operations you can do during your singing performance with Songs: Song playback, displaying score and lyrics, and Audio Song, and switching microphone-related functions.

Controlling Song Playback

Song playback can be controlled by pressing buttons on the panel or from the Song Playback display which is called up by pressing the SONG [PLAYER] button. The control displays for MIDI Song and Audio Song (if used) appear, allowing you to control the currently selected Songs on the screen.

Song Playback display

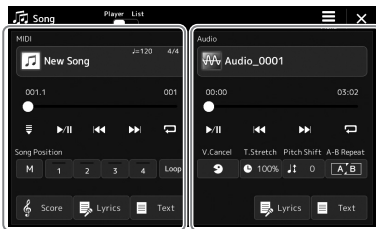

Song Player mode
(MIDI Song, Audio Song)

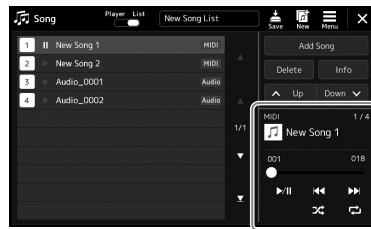

Song List mode
(Common for MIDI and Audio Songs)

NOTE

- For details on MIDI Song/Audio Song, switching between Song playback modes, and Song selection, refer to page 66.
- In the Song List mode, only basic playback operations are possible. On the other hand, you can playback multiple Songs continuously. For details, refer to the Reference Manual on the website.

Basic playback operations (for MIDI and Audio Songs)

SONG

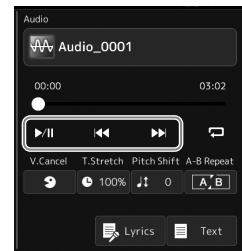
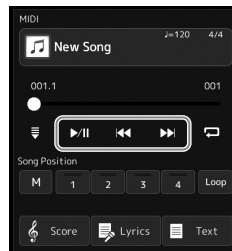
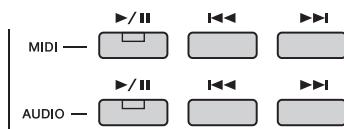

■ Play/Pause ([▶/⏸] (PLAY/PAUSE) button)

Press the [▶/⏸] (PLAY/PAUSE) button (or touch ▶/⏸) to start playback of the corresponding Song (MIDI or Audio). During playback, pressing it pauses playback. Pressing it again resumes Song playback from the current position.

■ Selecting previous/next Song ([◀◀] (PREV) or [▶▶] (NEXT) button)

Press the [◀◀] (PREV) or [▶▶] (NEXT) button (or touch ◀◀ or ▶▶) to select the previous/next Song. In the Song player mode, this operation selects the previous/next Song file in the same folder. In the Song List mode, this operation selects the previous/next Song on the Song List.

■ Rewind/Fast Forward ([◀◀] (PREV) or [▶▶] (NEXT) button)

Hold the [◀◀] (PREV) or [▶▶] (NEXT) button (◀◀ or ▶▶) to move backward/forward continuously through the current file.

NOTE

You can change the behavior when pressing the [◀◀] (PREV) button so that it only returns the playback position to the Song top and does not move to the previous Song, on the display called up via [MENU] → [Song Setting] → [Play]. For details, refer to the Reference Manual on the website.

Moving the Song Playback Position (Song Position pop-up window)

When you press and hold the [◀◀] (PREV) or [▶▶] (NEXT) button, a setting display appears showing the current position of the Song. When the window is shown on the display, you can also use the Data dial to move backward/forward continuously through the current file.

The Phrase Mark number appears only when a MIDI Song containing Phrase Marks is selected. You can select whether the Song playback position moves backward or forward in Bar or Phrase Mark units by touching the setting display beforehand.

NOTE

Phrase Mark is a pre-programmed marker in certain MIDI Song data, which specifies a specific location in the Song.

For Audio Songs

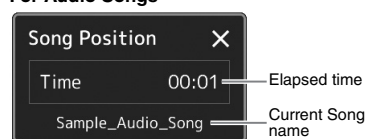

For MIDI Songs

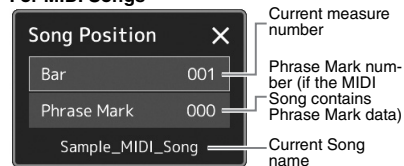

Moving the Song Playback Position (progress bar on the display)



In each Song area, the current position of the Song playback is shown. This can be moved forward or backward by moving the slider on the display.

Queuing the next Song for playback

While a MIDI Song is playing back, you can queue up the next MIDI Song for playback. This is convenient for chaining it to the next Song smoothly during live performance. To queue up, select the Song you want to play next in the Song Selection display, while a Song is playing back. The “Next” indication appears at the upper right of the corresponding Song name. To cancel this setting, touch  (Next Cancel) on the Song Selection display.

You can also queue up the next Audio Song for playback while a Audio Song is playing back, in the same way as for a MIDI Song.

NOTE

When the Recording function is used, the queue for playback is canceled.

Playback Operations exclusively for MIDI Songs

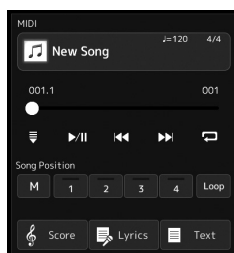

■ Synchro Start

You can conveniently start playback of a MIDI Song as soon as you start playing the keyboard. Touching  (Synchro start) puts Synchro Start in standby status, regardless of whether the Song is currently playing or stopped. To cancel the Synchro Start function, repeat the same operation.

■ Playback Using Song Position Markers ([M], [1]–[4], [Loop])

Using Song Position markers, you can navigate quickly and easily through the MIDI Song data, as well as set up convenient playback loops, for ease in song arranging. For details, refer to “Using Song Position Markers” (page 73).

Playback Operations exclusively for Audio Songs

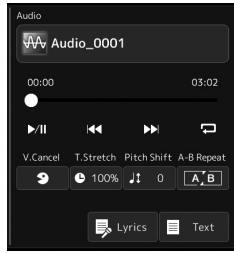



■ Vocal Cancel

This lets you cancel or attenuate the center position of the stereo sound in Audio Song playback. This lets you sing “karaoke” style with just instrumental backing, or play the melody part on the keyboard, since the vocal sound is usually at the center of the stereo image in most recordings.

To turn the Vocal Cancel function on/off, first select an Audio Song, and then turn on/off  (Vocal Cancel).

■ Time Stretch

Like Tempo adjustment of a MIDI Song, this lets you adjust the playback speed of an Audio Song by stretching or compressing it. To do this, touch  100% (Time Stretch) to call up the setup window. Touch  in this window to set the value (from 70% to 160%). Higher values result in a faster tempo.

■ Pitch Shift



Like the Transpose function of the MIDI Song, this lets you shift the pitch of an Audio Song in semitone steps (from -12 to 12).

■ A-B Repeat Playback

This lets you repeatedly play back a specified range (between points A and B).

1 Touch  (Play/Pause) to start playback.

2 Specify the repeat range.

When playback reaches the point you want to specify as the starting point (A), turn on  (A-B Repeat). When playback reaches the point you want to specify as the ending point (B), touch  (A-B Repeat) again. The range from Point A to Point B will be played back repeatedly.

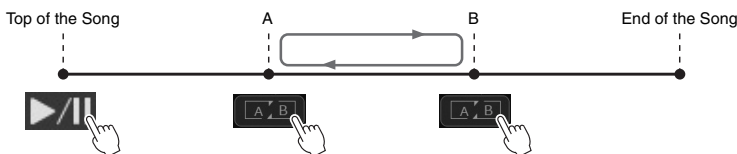

3 To cancel A-B repeat playback, turn off  (A-B Repeat).

The time of point A and B are cleared, and Repeat Playback is canceled.



NOTE

Though the Vocal Cancel function is highly effective on most audio recordings, the vocal sound on some songs may not be completely cancelled.

NOTE

Specifying only Point A results in repeat playback between Point A and the end of Song.

Specifying the repeat range while Song playback is stopped

1. Fast-forward the Song to Point A, and then turn on  (A-B Repeat).
2. Fast-forward the Song to Point B, and then touch  (A-B Repeat) again.

Using Song Position Markers (MIDI Songs only)

Song Position markers (SP1–SP4) can be placed in the MIDI Song data. These not only let you navigate quickly and easily through the MIDI Song data, but also let you set up convenient playback loops—allowing you to create dynamic Song arrangements “on the fly,” as you perform.

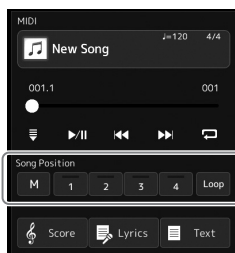

Entering Song Position Markers

- 1** Select the desired MIDI Song (page 68), and start playback (page 70).
- 2** Enter the Song Position markers.
 - 2-1** Touch **M** (Song Position Memorize) to turn it on.
 - 2-2** When the Song reaches the point at which you wish to enter a marker, touch the desired marker number ([1]–[4]) on the display.
The corresponding Song Position marker is entered, and Song Position Memorize is automatically turned off.
- 3** As desired, enter other markers in the same way as step 2.
- 4** Pause Song Playback (page 70).
- 5** Save the Song.
 - 5-1** Touch the Song name to call up the Song Selection Display.
 - 5-2** Save the Song file (page 33).

NOTICE

The entered marker settings will be lost if you change to another Song or you turn the power off without executing the Save operation.

About the status of Song Position [1]–[4]

- **Off:** Song Position is not entered to the button.
- **Green:** Song Position is entered to the button.
- **Red (flashes):** Playback jump is ready. See below (“Jumping to a Song Position Marker during playback”).
- **Red:** The Song Position has been passed and Song playback continues to the next Song button.

Jumping to a Song Position Marker during playback

Simply touching the one of the Song Position [1]–[4] during Song playback jumps to the corresponding position, after the current played measure reaches its end. (The button will flash in red, indicating that playback jump is ready.) You can cancel the jump by touching the same Song Position again before the actual jump.

Starting playback from a specific Marker

First, touch one of Song Position [1]–[4] while Song playback is stopped, and then start playback (page 70).

Using Markers in loop playback

In this section, we'll explain loop playback by the example of looping between markers [1] and [2].

1 Touch  (Play/Pause) to start playback from the top of the Song.

2 After passing the [1] point, touch  (Loop) to turn the loop function on.

The Song plays back up to the [2] point, then goes back to [1] and loops between the two points.

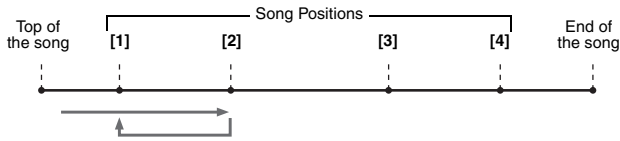

3 To stop the loop and continue normal playback, touch  (Loop) again.

When this is turned off, playback continues past the [2] point.

Displaying Score, Lyrics, and Text files during Playback

Displaying the music notation (Score) of a MIDI Song

You can view the music notation (score) of the selected MIDI Song. We suggest that you read through the music notation before starting to practice.

1 Select a MIDI Song (page 68).

2 Touch  **Score** (Score) on the Song Playback display to call up the Score display.

You can look through the entire notation by touching [◀] or [▶] when Song playback is stopped. While the Song is playing back, the “ball” bounces along through the score, indicating the current position.

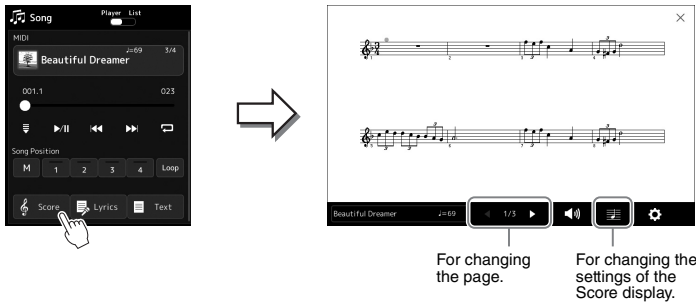

NOTE

- You can call up the Score display as well, via [MENU] → [Score].
- The instrument can display the music notation of commercially available music data or your own recorded Songs.
- The displayed notation is generated by the instrument based on the Song data. As a result, it may not be exactly the same as commercially available sheet music of the same song—especially when displaying notation of complicated passages or many short notes.

Changing the Size of the Score and Displaying Lyrics in a Score

By touching the note icon shown on the lower right of the display, you can change the settings of the Score display, such as changing the size of the score, or displaying note names or lyrics within the score, and so on. For details on the Score display, refer to the Reference Manual on the website.

NOTE

Lyrics can be shown only when the Song contains lyric data.

Displaying Lyrics of the Song

When the selected Song contains lyric data, you can view it on the instrument's display during playback.

1 Select a Song (page 68).

2 Touch (Lyrics) on the Song Playback display to call up the Lyrics display.

When the Song data contains lyrics data, the lyrics are shown on the display. You can look through the entire lyrics by touching [◀] or [▶] when Song playback is stopped. While the Song is playing back, the color of the lyrics changes, indicating the current position.

NOTE

- You can call up the Lyrics display as well, via [MENU] → [Lyrics].
- Audio Songs can also show lyrics as well as MIDI Songs, if the particular Song contains compatible lyrics data. For details, refer to the Reference Manual on the website.

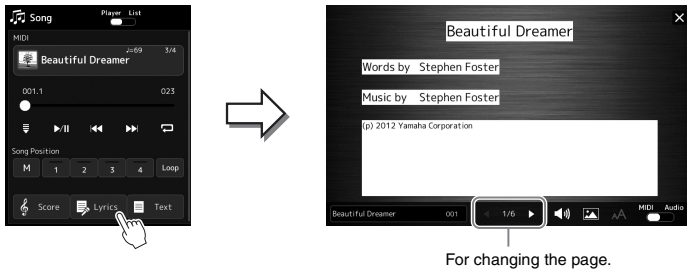

For details on the Lyrics display, refer to the Reference Manual on the website.

Displaying Text

Regardless of whether a Song is selected or not, you can view computer-created text files (.txt) on the instrument's display. To call up the display, touch  (Text) on the Song Playback display. This feature enables various useful possibilities, such as the showing of lyrics, chord charts and performance notes. For details on the Text display, refer to the Reference Manual on the website.

Using the Talk function

The Talk function lets you instantly change the microphone settings for speaking to your audience. This is useful when you want to make announcements between song performances without distracting reverb effects, etc.

1 Call up the Mic Setting display via [MENU] → [Mic Setting].

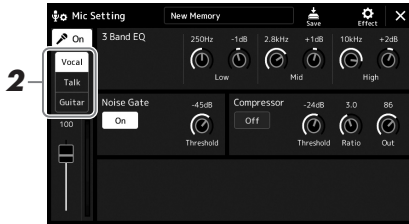

2 Touch [Talk] on the display to turn on the Talk function.

To turn the function off, touch [Vocal] on the display.

You can also change the Talk settings to suit your preferences. For details, refer to the Reference Manual on the website.

NOTE

To get the most convenient use of this function, you can assign a foot pedal or one of the ASSIGNABLE buttons to turn the Talk function on/off during a performance. For details, refer to the Reference Manual.

Selecting and/or Creating a Temperament (Scale Tune)

You can change the temperament of the instrument to fit the music you want to play. The operation display can be called up via [MENU] → [Scale Tune].

Basic Structure of Scale Tune

There are two ways to change the temperament; Main Scale and Sub Scale.

● Main Scale:

Sets the basic scale of the instrument. You can choose from an existing scale type or adjust it manually. The setting can be saved and called up by the Registration Memory function.

● Sub Scale:

Temporarily changes the scale only while the Sub Scale is enabled (e.g., when selected by pressing one of the SCALE TUNE MEMORY [1]–[5] buttons). This lets you temporarily set a Scale Tune setting (which is different from the Main Scale setting) to the desired parts. This setting takes priority over the Main Scale setting, regarding the checkmarked parts (see below). You can manually adjust the setting that can be memorized to the SCALE TUNE MEMORY [1]–[5] buttons or [1]–[5] on the Scale Tune display for instant recall.

You can enable/disable the Sub Scale by touching “Main/Sub” on the display, or by using the function “Scale Tune Quick Setting” that can be set to the assignable buttons or foot pedals. For details, refer to the Reference Manual on the website.

For which settings are applied to each part depending on the checkmarks on the display, see the examples below.

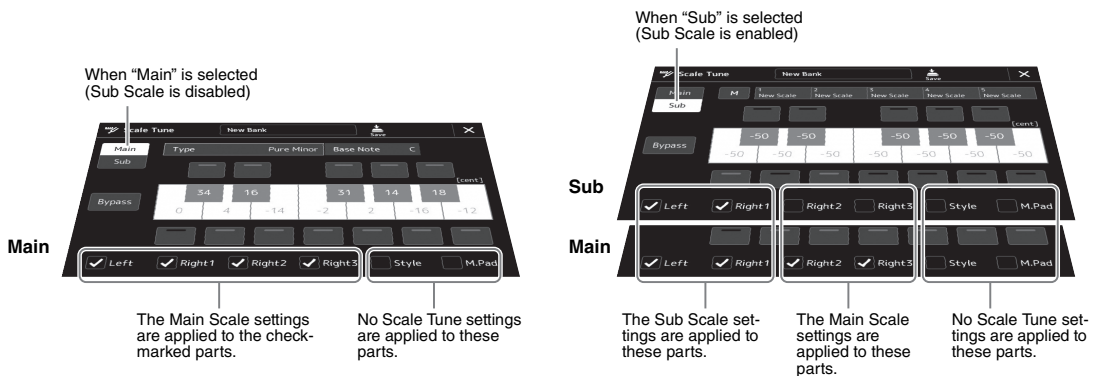

Selecting or Creating a Temperament from the Preset Types (Main Scale)

You can select various scales for playing in custom tunings for specific historical periods or music genres.

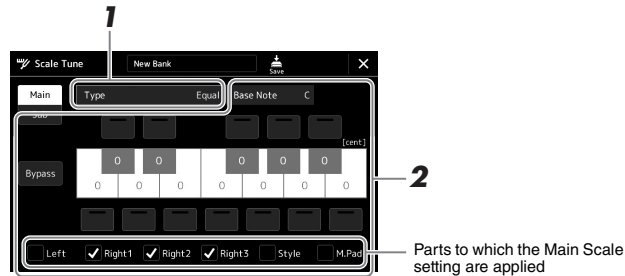

1 Select the desired Scale type (temperament).

Type	<ul style="list-style-type: none"> • Equal: The pitch range of each octave is divided equally into twelve parts, with each half-step evenly spaced in pitch. This is the most commonly used tuning in music today. • Pure Major, Pure Minor: These tunings preserve the pure mathematical intervals of each scale, especially for triad chords (root, third, fifth). You can hear this best in actual vocal harmonies—such as choirs and a cappella singing. • Pythagorean: This scale was devised by the famous Greek philosopher and is created from a series of perfect fifths, which are collapsed into a single octave. The 3rd in this tuning is slightly unstable, but the 4th and 5th are beautiful and suitable for some leads. • Mean-Tone: This scale was created as an improvement on the Pythagorean scale, by making the major third interval more “in tune.” It was especially popular from the 16th century to the 18th century. Handel, among others, used this scale. • Werckmeister, Kirnberger: This composite scale combines the Werckmeister and Kirnberger systems, which were themselves improvements on the mean-tone and Pythagorean scales. The main feature of this scale is that each key has its own unique character. The scale was used extensively during the time of Bach and Beethoven, and even now it is often used when performing period music on the harpsichord. • Bayati, Rast, Rast Jaharka, Rast Nawa, Rast Hosseini: Use these tunings when playing Arabic music.
------	--

2 Change the following settings as necessary.

Base Note	Determines the base note for each scale. When the base note is changed, the pitch of the keyboard is transposed, yet maintains the original pitch relationship between the notes.
Tune	<p>Touch the desired key of the keyboard illustration on the display, and then tune it in cents. The boxes at the upper and lower side of each key determines whether the tune setting is applied to the note. You can turn this on/off by touching it when the value is something other than 0. If you edit this parameter, “(Edited)” is shown at the right of “Type” in step 1.</p> <p>NOTE In musical terms a “cent” is 1/100th of a semitone. (100 cents equal one semitone.)</p>
Bypass	Turning this on with the [BYPASS] button or [Bypass] on the Scale Tune display disables all the Scale Tune settings temporarily. This lets you hear the sound for comparison purposes.
Parts (Left, Right 1, etc.)	Checkmark the part to which the Main Scale setting is applied.

To store the Scale Tune (Main Scale) settings

If you want to store the Scale Tune (Main Scale) settings, use the Registration Memory. Press the [MEMORY] button in the REGISTRATION MEMORY section, then checkmark “Scale Tune” and press one of the REGISTRATION MEMORY [1]–[8] buttons to register the Scale Tune settings.

Creating and Using a Temperament (Sub Scale)

You can create your own scales using the Sub Scale setting. This setting, when being edited, takes priority over the Main Scale setting. The setting is effective only while the Sub Scale is enabled (e.g., “Sub” is selected on the Scale Tune display)

- 1 On the Scale Tune display, touch [Sub] to select the Sub Scale setting.**

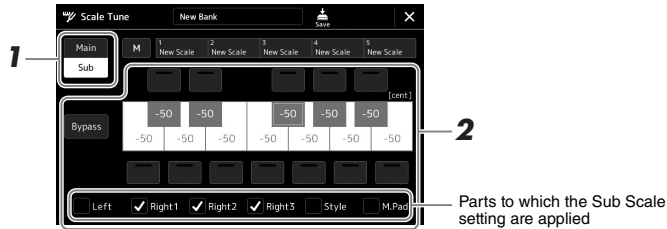

The Sub Scale setting is applied to checkmarked parts on bottom of the display. Even if the Sub Scale is selected, the Main Scale setting is applied to the parts which are not checkmarked on bottom of the Sub Scale display but checkmarked on the Main Scale display.

- 2 Change the following settings.**

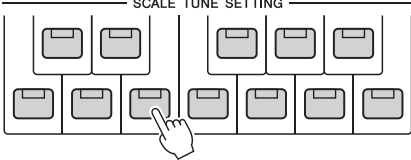
Tune	 <p>You can easily lower the pitches of the desired note by 50 cents. Turning the boxes on/off in the following ways lets you determine whether the tune setting is applied to the note or not.</p> <ul style="list-style-type: none"> • Pressing the SCALE TUNE SETTING buttons • Touching the boxes at the upper and lower side of the keyboard illustration <p>You can also adjust the tune value by touching the desired key illustration and tune it in cents.</p>
Bypass	Turning this on with the [BYPASS] button or [Bypass] on the Scale Tune display disables all the Scale Tune settings temporarily. This lets you hear the sound for comparison purposes.
Parts (Left, Right 1, etc.)	Checkmark the part to which the Sub Scale setting is applied.

If you return to the home display in this condition, the Sub Scale setting remains enabled.

- 3 To stop using the Sub Scale setting, touch [Main] on the Scale Tune display.**

The Sub Scale setting is disabled, and all Sub Scale tune settings are reset to their default values.

NOTE

The Sub Scale setting is also disabled and reset to default when the power of instrument is turned off.

NOTE

You can enable/disable the Sub Scale setting and make the Sub Scale setting quickly, using the function “Scale Tune Quick Setting,” which can be assigned to the assignable buttons or foot pedals. For details, refer to the Reference Manual on the website.

Memorizing the Sub Scale Setting

The Sub Scale setting you make (using the SCALE TUNE SETTING buttons and in the Scale Tune display) can be memorized to the SCALE TUNE MEMORY buttons for instant recall.

- 1 Set up the settings of Sub Scale as desired, using the SCALE TUNE SETTING buttons and the parameters in the Scale Tune display.**
- 2 While holding the SCALE TUNE MEMORY [MEMORY] button, press one of the SCALE TUNE MEMORY [1]–[5] buttons (the desired one for memorizing the Sub Scale setting).**

NOTE

The data memorized are the name, on/off, tuning values and enabled parts of Sub Scale Tune.

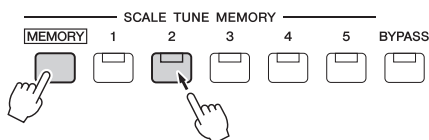

The corresponding SCALE TUNE MEMORY button lights. Any data that was previously in the selected location is erased and replaced by the new Sub Scale setting.

About the lamp status of the [1]–[5] buttons

- **On:** Data registered and currently selected
- **Off:** No data registered, or not currently selected

NOTE

The [BYPASS] button lights up when Bypass is on.

- 3 Memorize the Sub Scale settings to the other buttons by repeating steps 1 and 2.**

The memorized Sub Scale settings can be recalled by simply pressing the desired number button.

NOTICE

The scale settings memorized to the numbered button will be lost if you turn the power to the instrument off without carrying out the Save operation (see below).

Saving the Scale Tune Memory as a Bank File

The Sub Scale settings memorized to the SCALE TUNE MEMORY [1]–[5] buttons can be saved as a single Scale Tune Memory Bank file.

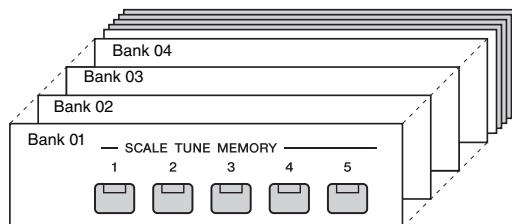

1 Make sure the Sub Scale settings you want to save are memorized to the SCALE TUNE MEMORY [1]–[5] buttons.

2 Touch  (Save) to save the Bank file.

For instructions on saving, refer to “File Management” (page 33).

Recalling a Memorized Sub Scale Setting

The memorized Sub Scale settings can be recalled by selecting the Scale Tune Memory Bank file as described below.

1 Call up the Scale Tune display via [MENU] → [Scale Tune].

2 Touch the Bank file name to call up the pop-up window.

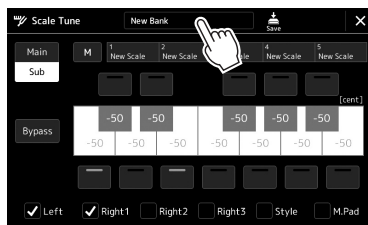

3 Touch and select the desired Bank on the display.

4 Touch and select the desired Sub Scale setting.

You can also use the SCALE TUNE MEMORY [1]–[5] buttons to select the Sub Scale setting.

Adjusting the Parameters of Each Part— Mixer

The Mixer gives you intuitive control over aspects of the keyboard parts and Song/Style channels, including volume balance and the timbre of the sounds. It lets you adjust the levels and stereo position (pan) of each Voice to set the optimum balance and stereo image, and lets you determine how the effects are applied. This section covers the basic procedures for the Mixer. For details, refer to the Reference Manual on the website.

Basic Procedure for the Mixer

1 Press the [MIXER/EQ] button to call up the Mixer display.



2 Touch the appropriate tab for editing the balance among the desired parts.

NOTE

You can also switch among the tabs by pressing the [MIXER/EQ] button.

Panel	Use this display when you want to adjust the balance among the entire Style part, entire Multi Pad part, Left part, Right 1–3 parts, entire MIDI Song part, Audio Song part, Mic part, Aux In Audio part, and the Wireless LAN Audio part (*). * An audio input via the optional wireless LAN adaptor. The optional USB wireless LAN adaptor may not be available depending on your area.
Style	Use this display when you want to adjust the balance among the channels of the Style. About each channel, refer to “Style Channels” (page 85).
M.Pad	Use this display when you want to adjust the balance among the four Audio Link Multi Pads.
Song	Use this display when you want to adjust the balance among all the parts of the MIDI Song.
Master	Unlike the other displays, use this display when you want to adjust the tonal characteristics of the entire sound (except for Audio Songs) of this instrument. For details on this display, refer to page 99.

3 Touch a tab for editing the desired parameters.

Filter	For adjusting Resonance, and Cutoff (sound brightness).
EQ	For adjusting equalization parameters to correct the tone or timbre of the sound.
Effect	For selecting an Effect type and adjusting its depth for each part.
Chorus/Reverb	For selecting a Chorus/Reverb type and adjusting its depth for each part.
Pan/Volume	For adjusting panning and volume for each part.

4 Set the value of each parameter.

5 Save your Mixer settings.

■ To save the Panel 1/2 Mixer settings:

Register them to Registration Memory (page 90).

■ To save the Style 1/2 Mixer Settings:

Save them as a Style file to the User drive or USB flash drive. If you want to recall the settings for future use, select the Style file saved here.

- 1 Call up the operation display via [MENU] → [Style Creator].
- 2 Touch [Save] to call up the Style Selection display, and then save the settings as a Style file (page 33).

■ To save the MIDI Song Ch 1–8 / 9–16 Mixer Settings:

When editing and saving the MIDI Song Channel settings, a different operation is needed. For details, see “Editing and Saving the MIDI Song Ch 1–8 / 9–16 Mixer Settings” below.

NOTE

To reset each parameter to the default value, touch the number value or setting and hold it.

Editing and Saving the MIDI Song Ch 1–8 / 9–16 Mixer Settings

First select a MIDI Song, and edit the parameters. Second, register the edited settings as part of the MIDI Song data (Setup), and then save the Song to the User drive or USB flash drive. If you want to recall the settings for future use, select the Song file saved here.

- 1 Call up the operation display via [RECORDING] → MIDI [Multi Recording].
- 2 Touch the Song name “New Song” to call up the Song Selection display, and then select the desired Song.
- 3 Edit the desired parameters, according to “Basic Procedure for the Mixer” (page 83) steps 1–4.
- 4 Press the [RECORDING] button to call up the MIDI Multi Recording display again.
- 5 Register the edited settings to the MIDI Song.
 - 5-1 Touch [Setup] to call up the Setup display.
 - 5-2 Touch [Execute] to register the edited settings as part of the MIDI Song data.
- 6 Touch [Save] to call up the Song Selection display, and then save the settings as a Song file (page 33).

Turning Each Channel of the Style or MIDI Song On/Off

You can add variations and change the feeling of a Style or a MIDI Song by selectively turning channels on/off.

Style Channels

Each Style contains the channels listed below.

- **Rhythm 1/2:** These are the basic parts of the Style, containing the drum and percussion rhythm patterns.
- **Bass:** The bass part uses various appropriate instrument sounds to match the Style.
- **Chord 1/2:** These comprise the rhythmic chord backing, commonly consisting of piano or guitar Voices.
- **Pad:** This part is used for sustained instruments such as strings, organ, choir, etc.
- **Phrase 1/2:** These parts are used for punchy brass stabs, arpeggiated chords, and other extras that make the accompaniment more interesting.

1 In the Mixer display, touch the [Style] tab or [Song] tab.

2 Touch the Channel which you want to turn on/off.



If you want to play back only one particular channel (solo playback), touch and hold the desired channel until the number is highlighted in purple. To cancel solo, simply touch the (purple) channel number again.

3 As necessary, make other settings, and then save them as a Style file or Song file (step 5 on page 84).

Changing the Voice for Each Channel of the Style or MIDI Song

You can change the Voice for each channel via the Mixer display.

- 1** In the Mixer display, touch the [Style] tab or [Song] tab.
- 2** Touch the instrument icon below the channel name to call up the Voice Selection display, and then select the desired Voice.



- 3** As necessary, make other settings, and then save them as a Style file or Song file (step 5 on page 84).

This instrument allows you to record your performance in two ways: MIDI recording and Audio recording. In addition, MIDI recording features two different methods: Quick Recording, which is the easiest, most convenient way to record, and Multi Recording, which allows you to record each channel or each track independently. In this section, we'll take a look at MIDI Quick Recording and Audio Quick Recording.

■ MIDI Quick Recording

With this method, recorded performances are saved to the instrument or a USB flash drive as an SMF (format 0) MIDI file. If you want to re-record a specific section or change Voices and edit other parameters, use this method. This instrument allows you to record up to approximately 3 MB per Song.

■ Audio Quick Recording

With this method, recorded performances are saved to the instrument as an Audio file. Recording is done without designating the recorded part. Since it is saved in stereo WAV format of normal CD quality resolution (44.1kHz/16-bit) by default, it can be transmitted to and played on portable music players by using a computer. It can also be recorded in MP3 format (44.1 kHz sample rate, 128/256/320 kbps bit rate, stereo). This instrument allows you to record up to 80 minutes per single recording.

Multi Recording

- **MIDI Multi Recording:** This lets you create a MIDI Song consisting of 16 channels by recording your performance to each channel one by one.

For details on Multi Recording, refer to the Reference Manual on the website.

MIDI Quick Recording

Before recording, make the necessary settings such as Voice/Style selection. As necessary, connect the USB flash drive to the [USB TO DEVICE] terminal. With this type of recording, each part will be recorded to the following channels.

- **Keyboard parts:** channels 1–4
- **Multi Pad parts:** channels 5–8
- **Style parts:** channels 9–16

1 Call up the MIDI Quick Recording display via [RECORDING] → MIDI [Quick Recording].

The display appears and a new blank Song is automatically set to record standby status.

NOTE

- Audio data such as the rhythm channels created via the audio data of Audio Link Multi Pad and Audio Link Songs cannot be recorded to the MIDI Songs.
- Before using a USB flash drive, be sure to read "Connecting USB Devices" on page 108.

NOTE

To cancel the recording, touch [Stop] on the display, and then press the [EXIT] button, before going on to step 2.

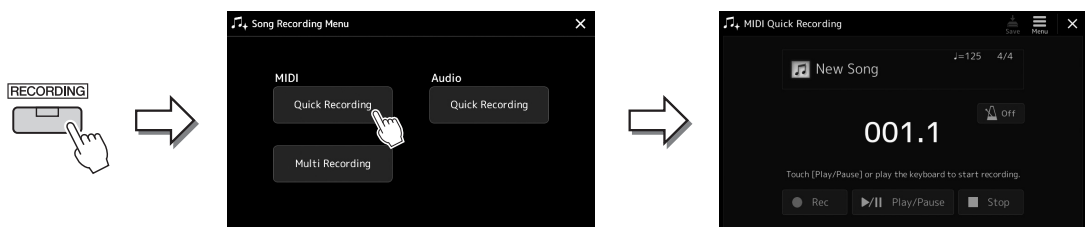

2 Start recording.

You can start recording by playing the keyboard, starting the Style, playing a Multi Pad, or touching [Play/Pause].

3 After you finish your performance, touch [Stop] to stop recording.

4 Touch [Save] to call up the Song Selection display, and then save the recorded performance as a file (page 33).

NOTICE

The recorded Song will be lost if you close the display or you turn the power off without executing the save operation.

Audio Quick Recording

Before recording, make the necessary settings such as Voice/Style selection and the microphone connection (if you want to record your singing).

1 Call up the Audio Quick Recording display via [RECORDING] → Audio [Quick Recording].

The display appears and a new empty audio file is created, with record standby status enabled. However, unlike MIDI Quick Recording, recording does not start automatically with keyboard performance, Style playback, or Multi pad playback.

NOTE

To cancel the recording, touch [Stop] on the display, and then press the [EXIT] button, before going on to step 2.

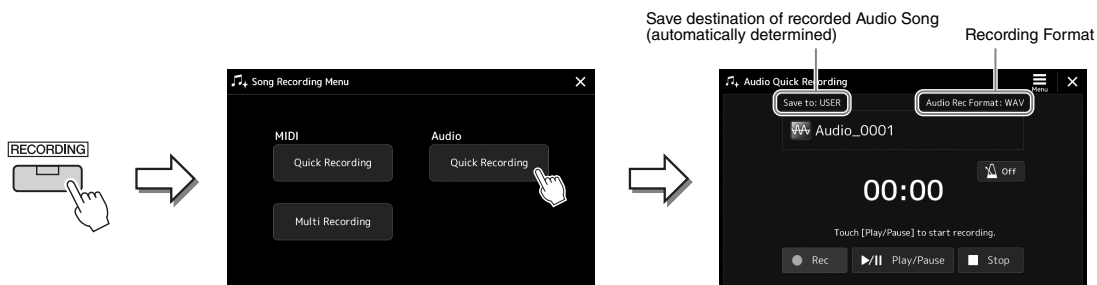

2 Touch [Play/Pause] to start recording.

Immediately after this operation, start and record your performance.

3 After you finish your performance, touch [Stop] to stop recording.

Recorded data is automatically saved to the destination as a file with the name automatically set. The recorded Audio Song appears in the User category on the Song Selection display.

NOTE

- The destination to save the recorded Audio Song is automatically determined, according to the connection status of the USB flash drive. You can change the priority storage setting via (Menu) on the display.
- You can also change the recording format via (Menu) on the display.

Storing and Calling up Custom Panel Set-ups—Registration Memory and Playlist

The Registration Memory function and the Playlist function allow you to save (or “register”) virtually all panel settings, and then instantly recall your custom panel settings for your performances by a simple, one-touch operation. The Playlist is especially useful for managing your repertoire, letting you select only the desired panel settings from the huge repertoire in the Registration Memory and create a new list.

■ Registration Memory

This function allows you to save (register) your custom panel settings to one of the Registration Memory buttons for easy recall.

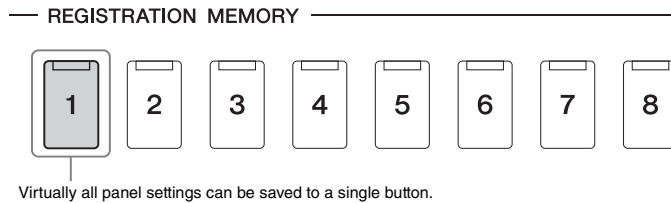

There are eight Registration Memory buttons on the panel. You can save all eight registered panel setups as a Single Registration Memory Bank file.

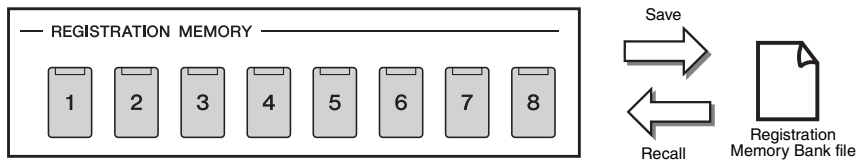

NOTE

For information on the parameters that can be registered with the Registration Memory function, refer to the Registration section of the “Parameter Chart” in the Data List on the website.

■ Playlist

The Playlist function allows you to create your own live performance set list. The advantage of this is that you can select only the specific files you want from the huge number of the Registration Memory Bank files—without having to change the bank file configuration. Each Playlist Record can directly recall a specified Registration Memory in the selected Registration Memory Bank file. You can collectively store the Playlist Records as a single Playlist file.

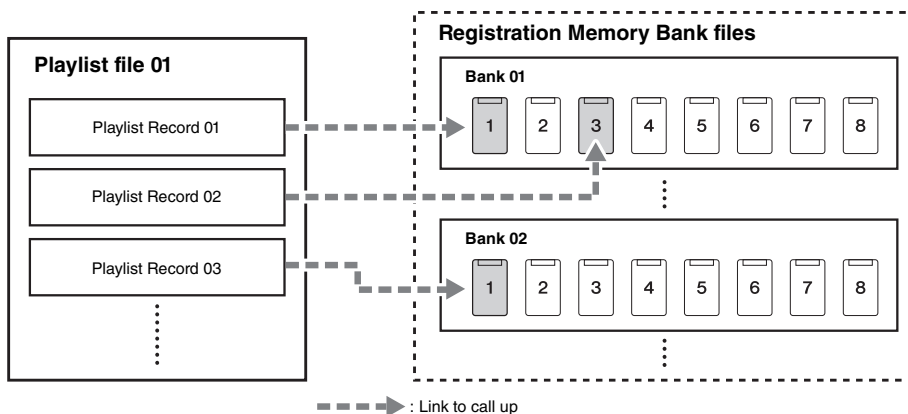

Saving and Recalling Custom Panel Setups with Registration Memory

Registering Your Panel Setups

- 1 Make the desired panel Settings, such as those for Voices, Styles and Effects.
- 2 Press the [MEMORY] button in the REGISTRATION MEMORY section to call up the Registration Memory window.

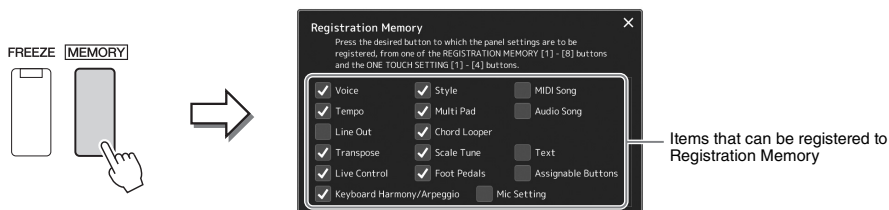

Selecting the items to be registered

The Registration Memory window shows a list of items that can be selected and registered. Before going on to step 3, enter or remove checkmarks by touching the desired items. Items having checkmarks will be registered.

- 3 Press the desired REGISTRATION MEMORY [1]–[8] button to which you wish to memorize the panel setup.

The memorized button lights in orange, which indicates that the button contains data and its number is selected.

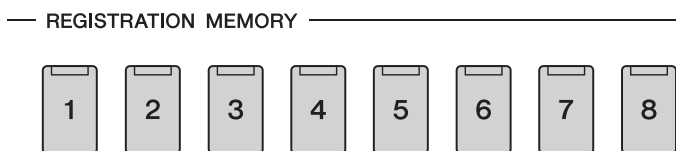

About the lamp status

- **Orange:** Data registered and currently selected
- **Blue:** Data registered but not currently selected
- **Off:** No data registered

- 4 Register various panel setups to other buttons by repeating steps 1–3.

The registered panel setup can be recalled by simply pressing the desired number button.

NOTICE

If you selected a button whose lamp is lit in orange or blue here, the panel setup previously memorized to the button will be erased and replaced by the new settings.

NOTE

The panel setups registered in the numbered buttons are maintained even when you turn off the power. If you want to delete all eight current panel setups, turn the power on while holding the B5 key (second right-most key) on the keyboard.

Saving the Registration Memory as a Bank file

You can save all eight registered panel setups as a Single Registration Memory Bank file.

- 1 Press the REGIST BANK [-] and [+] buttons simultaneously to call up the Registration Memory Bank Selection display.

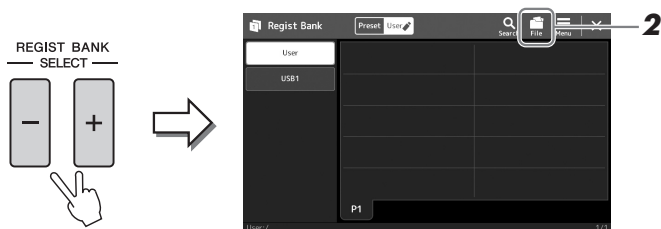

- 2 Touch  (File Edit) to call up the pop-up window, and then touch [Save] to save the Bank file.

For instructions on saving, refer to “File Management” (page 33).

NOTE

You can tag Registration Memory Bank files for easy search. For details, refer to the Reference Manual on the website.

Recalling a Registered Panel Setup from a Bank file

The saved Registration Memory Bank files can be recalled by using the REGIST BANK [-]/[+] buttons or the following procedure.

- 1 Press the REGIST BANK [-] and [+] buttons simultaneously to call up the Registration Memory Bank Selection display.
- 2 Touch and select the desired Bank on the display.
You can also use the REGIST BANK [-]/[+] buttons to select a Bank.
- 3 Press one of the blue-lit numbered buttons ([1]–[8]) in the Registration Memory section.
The selected button lights in orange.

NOTE

- When recalling setups that include Song, Style or text files selected from a USB flash drive, make sure that the appropriate USB flash drive containing the registered Song, Style or text is connected into the [USB TO DEVICE] terminal.
- Before using a USB flash drive, be sure to read “Connecting USB Devices” on page 108.

NOTE

Turning the [FREEZE] button on lets you disable recall of specific item(s) as desired. For instructions, refer to the Reference Manual on the website.

NOTE

You can also call up the eight setups by using pedals or Assignable buttons in any order you specify via [MENU] → [Regist Sequence]. For details, refer to the Reference Manual on the website.

Confirming the Registration Memory Bank Information

You can call up the information display to confirm which Voices, Style and Songs are memorized to the [1]–[8] buttons of a Registration Memory Bank.

1 Call up the Registration Memory Bank Selection display, then select the desired Bank.

2 Touch  (Menu) then [Regist Bank Info] to call up the Regist Bank Information display.

This display consists of two pages: Voice-related, and Style-related. You can switch between the two via [Voice]/[Style] on the display.

NOTE

If a certain Voice part is set to off, the Voice name for the corresponding part is shown in gray.

For switching pages.



Touch to select the desired Registration Memory. The selected Registration is automatically loaded.

3 Press the [EXIT] button to close the information display.

Editing a Registration Memory Bank

You can edit a Registration Memory Bank (delete or rename each Registration Memory, etc.) in the Regist Bank Edit display.

1 Call up the Registration Memory Bank Selection display, then select the desired Bank.

2 Touch  (Menu) then [Regist Bank Edit] to call up the Regist Bank Edit display.

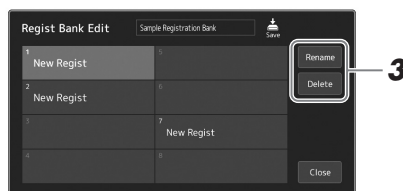

3 Edit the Registration Memory Bank information.

Touch to select the desired Registration Memory. The Registration Memory is selected as a editing target, but not actually loaded.

- To change the name of the selected Registration, touch [Rename].
- To delete the selected Registration, touch [Delete].

4 Touch  (Save) to save the edited Registration Memory Bank file.

Managing a Large Repertoire by Using the Playlist

The Playlist is useful for managing multiple set lists for your live performances. It lets you select just the specific files you want from a large repertoire (the huge number of the Registration Memory Bank files) and create a new set list for each performance.

Creating a new Playlist

- 1 Press the [PLAYLIST] button to call up the Playlist display.

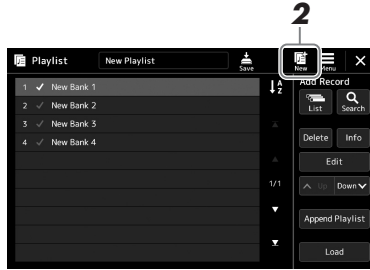

- 2 Touch  (New) on the display.

A new Playlist file is created.

Adding a Record to the Playlist

By adding a Record to the Playlist, you can directly recall your desired Registration Memory.

- 1 Press the [PLAYLIST] button to call up the Playlist display.

The Playlist file which was selected the last time appears. (The sample preset Playlist will appear for the first time.)

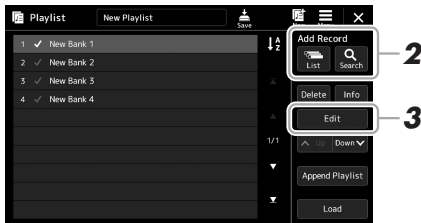

- 2 Add a Record to the Playlist.

- To add a Record via the Registration Memory Bank Selection display:

- 2-1 Touch Add Record [List] on the display.

The Registration Memory Bank Select display appears.

- 2-2 Select the desired Registration Memory Bank file to register as a Playlist Record.

Touching [Add to Playlist] closes the display, and the new Playlist Record is added to the Playlist.

● **To add a Record by using the search function:**

Touching Add Record [Search] on the display calls up the operation display for searching for the desired Registration Memory Bank file. For details on searching for files, refer to the Reference Manual on the website.

From the search result, select the desired file and then touch [Add to Playlist] to close the display, and the new Playlist Record is added.

3 If necessary, edit the Playlist Record.

The newly added Playlist Record simply recalls the selected Registration Memory Bank file. If you want to set more detailed settings (such as directly recalling a specified Registration Memory and automatically switching the screen view), you can edit the Playlist Record.

3-1 Touch [Edit] to call up the Record Edit display.

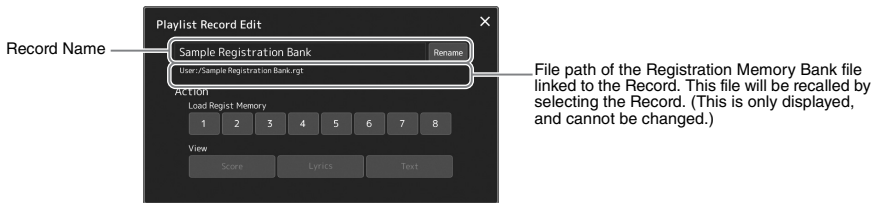

3-2 Touch to edit the Record.

Record Name	Determines the name of the Record. Touching [Rename] calls up the Character Entry window.
Action	Additional actions after selecting the Record and recalling the Bank. <ul style="list-style-type: none"> • Load Regist Memory: Recalls the Registration Memory corresponding to the selected number. When no item is selected, no Registration Memory is recalled. • View: Displays the selected view. When no item is selected, no view is displayed.

3-3 Close the display.

4 Touch  (Save) to save the added Record to the current Playlist file.

To recall the registered Record, touch the desired Record on the Playlist display.

Recalling custom panel setups via the Playlist

- 1 Press the [PLAYLIST] button to call up the Playlist display.



- 2 Touch the Playlist file name to call up the Playlist File Selection display.
- 3 Touch the desired Playlist file, and then close the display.
- 4 Touch the Record name on the Playlist display, and then touch [Load].



The Registration Memory Bank registered as the Playlist Record is recalled and the Action you've made is executed (page 93.)

Copying the Playlist Records (Append Playlist)

“Append Playlist” allows you to copy the existing Playlist file as a new Playlist file.

- 1 Press the [PLAYLIST] button to call up the Playlist display.
- 2 Touch [Append Playlist] on the display.
The Playlist File Selection display appears.
- 3 Touch the desired Playlist file to append.
All Records in the selected Playlist file are added at the bottom of the current Playlist.
- 4 Touch  (Save) to save the appended Records to the current Playlist file.

Changing the order of the Records in the Playlist

- 1** Press the [PLAYLIST] button to call up the Playlist display.
- 2** Change the order of the Records.
 - 2-1** Touch the desired Record you want to move.
 - 2-2** Touch  (Up)/  (Down) to move the Record you selected in Step 2-1.
- 3** Touch  (Save) to save the edited Playlist file.

Deleting the Playlist Record from the Playlist

- 1** On the Playlist display, touch the desired Record to select it.
- 2** Touch [Delete] on the display.

A confirmation message appears here. To cancel the deletion, touch [No].
- 3** Touch [Yes].
- 4** Touch  (Save) to save the edited Playlist file.

Sorting the Playlist in alphabetical order

- 1** Press the [PLAYLIST] button to call up the Playlist display.
- 2** Touch  on the display.

The Playlist items are sorted in alphabetical order. To cancel sorting, touch  again.

Customizing for Optimum Performance

You can customize the instrument for your own personal preferences and optimum performance. This section covers how to edit shortcuts on the Home display, set ASSIGNABLE buttons, make global settings, adjust the sound at the final output, and add expansion contents, such as Voices and Styles.

Customizing the Shortcuts on the Home Display

You can register an often used function to a shortcut on the Home display. Although six shortcuts are registered by default, you can customize them as necessary. Registered shortcuts are shown in the Shortcut area (page 26) at the bottom of the Home display, allowing you to quickly call up the desired function from the Home display.

- 1 Call up the Assignable display via [MENU] → [Assignable].

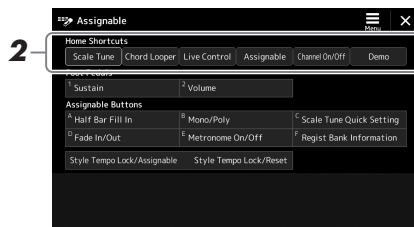

- 2 Double-tap (touch twice) the desired item from the six locations of the “Home Shortcuts” area.

The function selection pop-up window appears.

- 3 Touch the desired function.

The function will be registered to the location selected in step 2.

Setting the Functions or Shortcuts to the ASSIGNABLE Buttons

You can assign various control functions or shortcuts to the ASSIGNABLE buttons, allowing you to quickly operate or call up the desired function.

- 1 Call up the Assignable display via [MENU] → [Assignable].

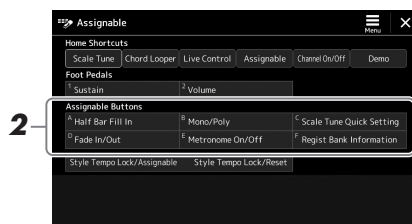

- 2 Double-tap (touch twice) the desired item from the “Assignable Buttons” area.

The function selection pop-up window appears.

- 3 Touch the desired function.

The function will be registered to the location selected in step 2.

NOTE

For details on assignable parameters and functions, refer to the Reference Manual on the website.

Making Global Settings (Utility)

The Utility function provides a variety of convenient tools and settings for this instrument. These include general settings that affect the entire instrument, as well as detailed settings for specific functions. Also included are data reset functions and storage media control, such as disk formatting.

Basic Procedure

1 Call up the operation display.

[MENU] → [Utility]

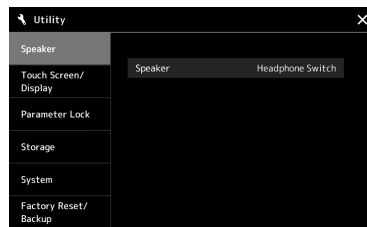

2 Touch the desired tab to call up the desired page, and change the settings or execute the operation.

Speaker	Determines how the sound is output from the speaker.
Touch Screen/Display	Contains display-related settings such as brightness, and touch sound On/Off settings.
Parameter Lock	Specifies the parameters to make them selectable only via the panel control.
Storage	Lets you execute the Format operation or check the memory capacity (approximate value) of the USB flash drive connected to this instrument. (page 109)
System	Indicates the firmware version and the hardware ID of this instrument, and lets you make basic settings, such as the language for the display, Auto Power Off function On/Off. (pages 21, 101)
Factory Reset/Backup	Backs up/restores whole or a part of the instrument or initializes the instrument to the factory default. (page 102)

For more information of each tabs, refer to the “Utility” section of the Reference Manual on the website.

Adjusting the Sound at the Final Output (Master Compressor, Master EQ)

You can adjust the sound quality and the volume at the final output from the instrument by making the Master Compressor and the Master EQ settings.

- 1** Press the [MIXER/EQ] button to call up the Mixer display.
- 2** Touch the “Master” tab.



- 3** Touch a tab for editing the desired parameters.

Compressor	Lets you turn the Master Compressor (which is applied to the entire sound except audio playback) on or off, select the Master Compressor type, and edit the related parameters. Your original edits can be saved as the Master Compressor type.
EQ	Lets you select the Master EQ type applied to the entire sound except audio playback and edit the related parameters. Your original edits can be saved as the Master EQ type.

NOTE

For more information about these parameters, refer to the Reference Manual on the website.

- 4** Set the value of each parameter.

- 5** Save the settings.

Your original edits can be stored as a Master Compressor type and Master EQ type. If you want to recall the settings for future use, select the corresponding type at the upper right of each display.

- 5-1** Touch  (Save) in the “Compressor” display or “EQ” display.
- 5-2** Select one of the USER1–USER30 settings, and then touch [Save] to call up the Character Entry window.
- 5-3** In the Character Entry window, change the name as necessary, then touch [OK] to save the data.

NOTE

To reset each parameter to the default value, touch the number value or setting and hold it.

Adding New Contents—Expansion Packs

By installing Expansion Packs, you can add a variety of optional Voices and Styles to the “Expansion” folder in the User drive. The installed Voices and Styles can be selected via the User tab in the Voice or Style Selection displays, allowing you to expand your music performance and creation possibilities. You can get high quality Expansion Pack data created by Yamaha, or create your own original Expansion Pack data by using the “Yamaha Expansion Manager” software on your computer. For instructions on how to install the Expansion Packs, refer to the Reference Manual on the website.

For more information about Expansion Packs, access the Sound & Expansion Libraries page at the Yamaha MusicSoft website:

<https://www.yamahamusicsoft.com/sound-and-expansion-libraries/>

To obtain the Yamaha Expansion Manager software and its manuals, access the following website, and search by the model name of your instrument, “PSR-A5000.”

<https://download.yamaha.com/>

This section explains how to make important overall, system-related settings, including backup/restore of settings and file data.

Confirming the Firmware Version and Hardware ID

You can check the firmware version and hardware ID of this instrument.

1 Call up the operation display via [MENU] → [Utility].

2 Touch [System].

The program version and the hardware ID are shown in the display.

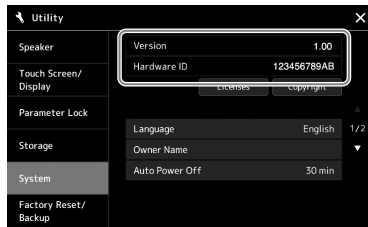

Restoring the Factory-programmed Settings

While holding the right-most key on the keyboard, turn the power on. This restores all settings to their factory defaults.

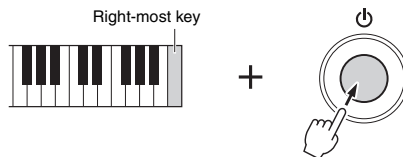

NOTE

- You can also restore the factory default value of specified settings or delete all files/folders in the User drive on the display called up via [MENU] → [Utility] → [Factory Reset/Backup] → page 1/2. For details, refer to the "Utility" section of the Reference Manual on the website.
- If you simply want to restore the default value of any parameter you've changed, touch and hold the value on the display (page 30).

Data Backup and Restore

Data Backup

You can back up all data in the User drive of this instrument (except for Expansion Voices/Styles) and all settings to the USB flash drive as a single file. This procedure is recommended for data security and backup in case of damage.

- 1** Connect the USB flash drive to the [USB TO DEVICE] terminal as backup destination.
- 2** Call up the display via [MENU] → [Utility] → [Factory Reset/Backup] → page 2/2.

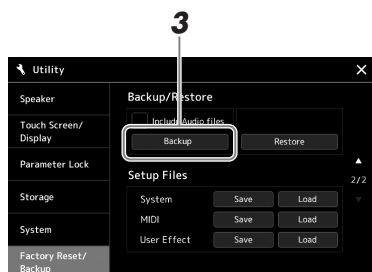

If you want to include audio files to the backup file:

Before going on to step 3, enter a checkmark by touching the “Include Audio files” checkbox.

- 3** Touch [Backup] to save the backup file to the USB flash drive.

Restoring the Backup file

To do this, touch [Restore] in step 3 above. When the operation is complete, the instrument will be restarted automatically.

NOTE

- Before using a USB flash drive, be sure to read “Connecting USB Devices” on page 108.
- You can back up User data such as Voice, Song, Style, and Registration Memory by copying them individually to a USB flash drive. For instructions, refer to page 33.
- If the total size of the target data for backup exceeds 3.9 GB (excluding Audio files), the backup function is not available. If this happens, back up the User data by copying the items individually.
- You can save the System settings, MIDI settings and User Effect settings individually.

NOTICE

Completing the backup/restore operation may take a few minutes. Do not turn off the power during backup or restoring. If you turn off the power during backup or restoring, data may be lost or damaged.

Connections—Using Your Instrument with Other Devices

This chapter covers the connections of this instrument to other devices. To see where the connectors are located on the instrument, refer to pages 16–19.

⚠ CAUTION

Before connecting the instrument to other electronic components, turn off the power of all components. Also, before turning any components on or off, make sure to set all volume levels to minimum (0). Otherwise, damage to the components, electrical shock, or even permanent hearing loss may occur.

Connecting a Microphone or Guitar ([MIC/GUITAR INPUT] jack)

By connecting a microphone, you can sing along with your keyboard performance or with Song playback, as well as record your vocal performance to an Audio Song. You can also connect a guitar to the [MIC/GUITAR INPUT] jack, and output the sound from the speakers of this instrument.

Connecting a microphone or guitar to the instrument

- 1 Before connecting a microphone or guitar, set the [GAIN] knob to the minimum position.

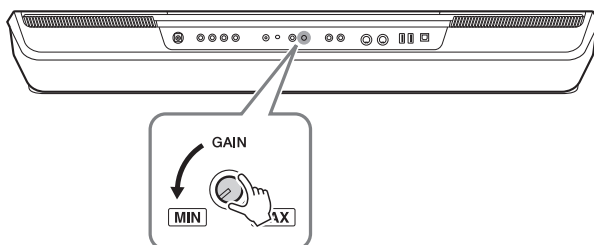

- 2 Set the [MIC GUITAR] switch.

When connecting a microphone, set it to “MIC.” When connecting a guitar, set it to “GUITAR.”

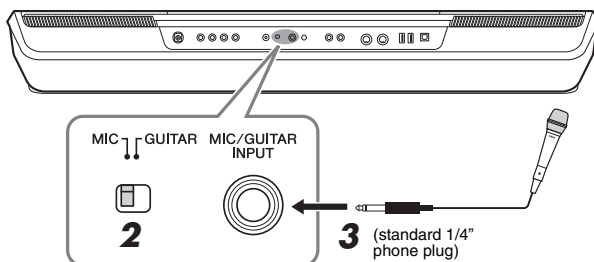

NOTE

Make sure to use a conventional dynamic microphone.

NOTE

- When you are not using a microphone/guitar, disconnect the cable from the [MIC/GUITAR INPUT] jack.
- Always set the [GAIN] knob to minimum when nothing is connected to the [MIC/GUITAR INPUT] jack. Since the [MIC/GUITAR INPUT] jack is highly sensitive, it may pick up and produce noise even when nothing is connected.

NOTE

When you use a guitar with active pickups, set the [MIC GUITAR] switch to “MIC,” since doing so can reduce noise.

- 3** Connect the microphone or guitar to the [MIC/GUITAR INPUT] jack.
- 4** Turn on the power of the instrument.

Adjusting the input level of the microphone or guitar

- 1** If necessary, turn on the microphone.
- 2** Call up the Mic Setting display via [MENU] → [Mic Setting].



Input level meter

NOTE

The Mic Setting display can also be called up by pressing the [MIC SETTING] button.

- 3** Adjust the [GAIN] knob on the rear panel while singing into the microphone or playing the guitar.
Adjust the [GAIN] knob so that the input level meter on the display lights in green or yellow. Make sure that the meter does not light in orange or red, since this indicates that the input level is too high.
- 4** Adjust the volume balance between the microphone or guitar sound and the instrument sound on the Mixer display (page 83).

NOTE

You can also check the input level on the SIGNAL lamp on the [MIC SETTING] button. Make sure that the lamp does not light in orange.

Disconnecting the microphone or guitar

- 1** Set the [GAIN] knob on the rear panel to the minimum position.
- 2** Disconnect the microphone or guitar from the [MIC/GUITAR INPUT] jack.

Using an External Speaker System for Playback (MAIN OUTPUT jacks, SUB (AUX) OUTPUT jacks)

The MAIN OUTPUT jacks are used to send this instrument's output to a keyboard amplifier, stereo sound system or mixing console. If you are connecting the instrument to a mono sound system, use only the MAIN OUTPUT [L/L+R] jack. When only this jack is connected (using a standard phone plug), the left and right channels are combined and output through this jack—providing a convenient mono mix of the stereo sound.

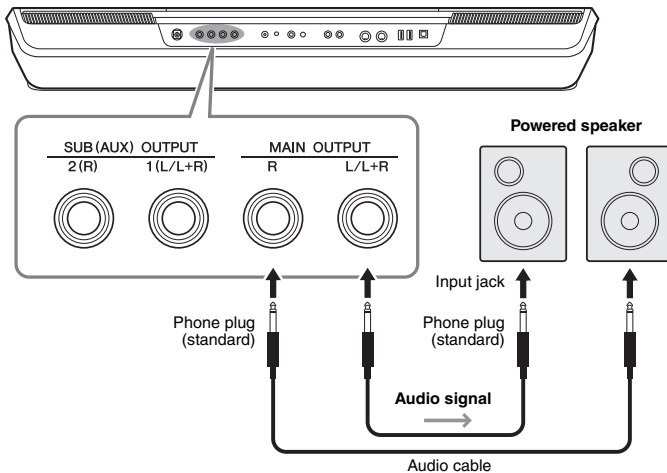

You can use the instrument's [MASTER VOLUME] dial to adjust the volume of the sound output to the external device.

Using the SUB (AUX) OUTPUT jacks

You can use the SUB (AUX) OUTPUT jacks as SUB OUTPUT jacks, sending a specific part to any desired SUB (AUX) OUTPUT jack. Also, you can use these jacks as AUX OUTPUT jacks by switching the function of the jacks to "AUX."

The operation display can be called up via [MENU] → [Line Out]. For details, refer to the Reference Manual on the website.

NOTICE

Do not route the output from the SUB (AUX) OUTPUT jacks to the AUX IN jack. If you make this connection, the signal input at the AUX IN jack is output from the SUB (AUX) OUTPUT jacks, possibly resulting in a feedback loop that will make normal performance impossible, and may even damage the equipment.

NOTE

The output volume from SUB (AUX) OUTPUT jacks cannot be controlled by the MASTER VOLUME control.

NOTE

Use audio cables and adaptor plugs having no (zero) resistance.

NOTICE

To avoid possible damage, first turn on the power to the instrument, and then to the external device. When turning off the power, do the opposite: first turn off the power to the external device, and then to the instrument. Since this instrument's power may automatically be turned off due to the Auto Power Off function (page 21), turn off the power to the external device, or disable Auto Power Off when you do not intend to operate the instrument.

Listening to Audio Playback by the External Device through the Instrument's Speaker

Audio playback by the connected device can be output from the instrument's speaker. To input audio, connect an external device by the method below.

NOTE

- The volume of the audio input can be adjusted from the external device.
- You can adjust the volume balance among the sounds of the instrument and the audio input in the Mixer display. (page 83)

Connecting to an audio player by using an audio cable ([AUX IN] jack)

You can connect the headphone jack of an audio player such as a smartphone and portable audio player to the instrument's [AUX IN] jack. Audio playback on the connected device is output from the built-in speakers of this instrument.

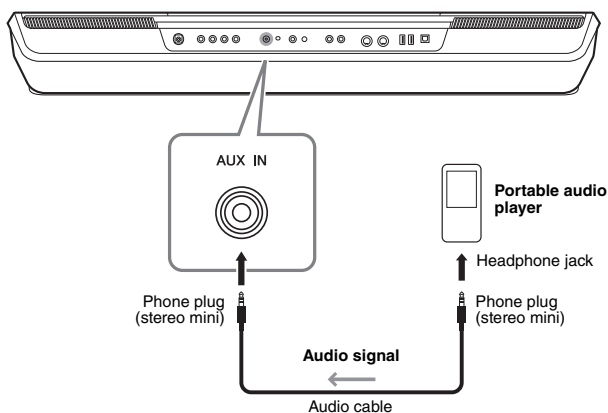

NOTICE

To avoid damage to the devices, first turn on the power to the external device, and then to the instrument. When turning off the power, first turn off the power to the instrument, and then to the external device.

NOTE

- The input signal from the AUX IN jack is affected by the setting of the instrument's [MASTER VOLUME] dial, and the volume balance with other parts such as entire keyboard can be adjusted by the Mixer display (page 83).
- Use audio cables and adaptor plugs having no (zero) resistance.

Connecting Footswitches/Foot Controllers (FOOT PEDAL jacks)

The FC4A or FC5 footswitches and the FC7 foot controller (sold separately) can be connected to one of the FOOT PEDAL jacks. A footswitch can be used for switching functions on and off, while a foot controller controls continuous parameters, such as volume.

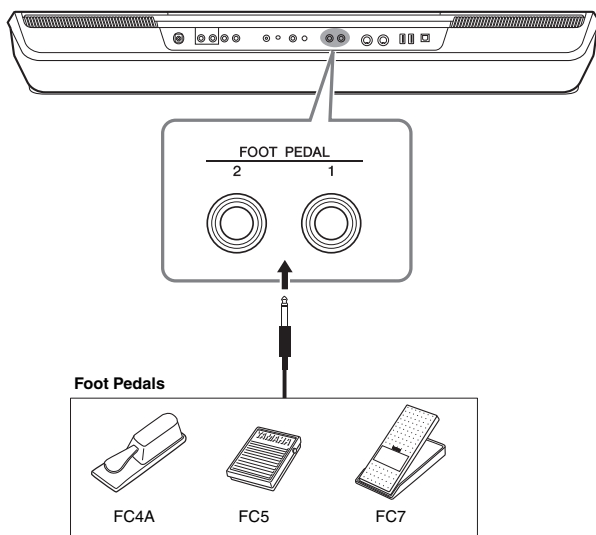

NOTE

Do not connect or disconnect the pedal when the power is on.

By default, each jack features the following function. Use the FC4A or FC5 footswitch.

- **FOOT PEDAL [1]**..... Switches sustain on or off.
- **FOOT PEDAL [2]**..... Controls volume.

You can also change the function assignments to the pedals as desired.

● Example: Controlling MIDI Song Start/Stop by footswitch

Connect a footswitch (FC4A or FC5) to one of the FOOT PEDAL jacks.

To assign the function to the connected pedal, select “Song MIDI Play/Pause” in the operation display: [MENU] → [Assignable].

NOTE

For a list of the functions you can assign to the pedals, refer to the Reference Manual on the website.

Connecting USB Devices ([USB TO DEVICE] terminal)

You can connect a USB flash drive or a USB wireless LAN adaptor to the [USB TO DEVICE] terminal. This allows you to save data you've created on the instrument to the USB flash drive (page 33), as well as connect and use the instrument with a smart device via a USB wireless LAN adaptor (page 109).

Precautions when using the [USB TO DEVICE] terminal

This instrument features a built-in [USB TO DEVICE] terminal. When connecting a USB device to the terminal, be sure to handle the USB device with care. Follow the important precautions below.

NOTE

For more information about the handling of USB devices, refer to the owner's manual of the USB device.

● Compatible USB devices

- USB flash drive
- USB wireless LAN adaptor (UD-WL01; sold separately)

Other USB devices such as a computer keyboard or mouse cannot be used.

The instrument does not necessarily support all commercially available USB devices. Yamaha cannot guarantee operation of USB devices that you purchase. Before purchasing a USB device for use with this instrument, please visit the following web page:

<https://download.yamaha.com/>

Although USB devices 1.1 to 3.0 can be used on this instrument, the amount of time for saving to or loading from the USB device may differ depending on the type of data or the status of the instrument.

NOTICE

The rating of the [USB TO DEVICE] terminal is a maximum of 5V/500mA. Do not connect USB devices having a rating above this, since this can cause damage to the instrument itself.

● Connecting a USB device

When connecting a USB device to the [USB TO DEVICE] terminal, make sure that the connector on the device is appropriate and that it is connected in the proper direction.

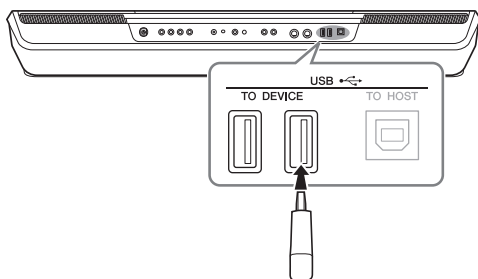

NOTICE

Avoid connecting or disconnecting the USB device while executing playback/recording and file management operations (such as Save, Copy, Delete and Format), or when accessing the USB device. Failure to observe this may result in "freezing" of the operation of the instrument or corruption of the USB device and the data.

NOTICE

- When connecting then disconnecting the USB device (and vice versa), make sure to wait a few seconds between the two operations.
- Do not use an extension cable when connecting a USB device.

NOTE

If you intend to connect two or more devices at the same time to a terminal, you should use a bus-powered USB hub. Only one USB hub can be used. If an error message appears while using the USB hub, disconnect the hub from the instrument, then turn on the power of the instrument and reconnect the USB hub.

● Using USB flash drives

By connecting the instrument to a USB flash drive, you can save data you've created to the connected device, as well as read data from the connected device.

● Maximum number of USB flash drives allowed

Up to four USB flash drives can be connected to the [USB TO DEVICE] terminal. (If necessary, use a USB hub. The number of USB flash devices that can be used simultaneously with musical instruments even when a USB hub is used is a maximum of four.)

● Formatting a USB flash drive

You should format the USB flash drive only with this instrument (page 109). A USB flash drive formatted on another device may not operate properly.

NOTICE

The format operation overwrites any previously existing data. Make sure that the USB flash drive you are formatting does not contain important data. Proceed with caution, especially when connecting multiple USB flash drives.

● To protect your data (write-protect)

To prevent important data from being inadvertently erased, apply the write-protect provided with each USB flash drive. If you are saving data to the USB flash drive, make sure to disable write-protect.

● Turning off the instrument

When turning off the instrument, make sure that the instrument is NOT accessing the USB flash drive by playback/recording or file management (such as during Save, Copy, Delete and Format operations). Failure to do so may corrupt the USB flash drive and the data.

Formatting a USB flash drive or the internal User drive

To format a USB flash drive or the internal User drive, execute the Format operation. In order to format a USB flash drive, make sure that a USB flash drive is properly connected to the [USB TO DEVICE] terminal beforehand.

- 1 Connect a USB flash drive for formatting to the [USB TO DEVICE] terminal.
- 2 Call up the operation display via [MENU] → [Utility] → [Storage].

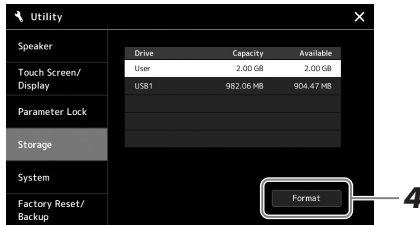

- 3 Touch the name of the desired drive to be formatted in the device list.

The indications USB 1, USB 2, etc. are displayed, depending on the number assigned to the connected device.

- 4 Touch [Format] to execute the Format operation, and then follow the onscreen instructions.

NOTICE

The Format operation deletes any previously existing data. Make sure that the USB flash drive you are formatting does not contain important data. Proceed with caution, especially when connecting multiple USB flash drives.

Connecting to a smartphone/tablet ([USB TO DEVICE], [USB TO HOST], or MIDI terminals)

You can use a smart device, such as a smartphone or tablet, with the instrument for a variety of musical purposes by connecting it to the instrument. By using application tools on your smart device, you can take advantage of convenient functions and get more enjoyment out of this instrument.

You can make connections by one of the following methods.

- Connect to the [USB TO DEVICE] terminal via the USB wireless LAN adaptor: UD-WL01 (*).
- Connect to the [USB TO HOST] terminal via a Wireless MIDI Adaptor: UD-BT01 (*).
- Connect to the MIDI terminals via a Wireless MIDI Adaptor: MD-BT01 (*).

* These accessories are sold separately, but may not be available depending on your area.

For details on connections, refer to the “Smart Device Connection Manual” and the Reference Manual on the website.

For information about the compatible smart devices and application tools, access the following page:

<https://www.yamaha.com/kbdapps/>

NOTICE

- Do not place your smart device in an unstable position. Doing so may cause the device to fall and result in damage.
- Do not connect this product to a public Wi-Fi and/or Internet service directly. Only connect this product to the Internet through a router with strong password protections. Consult your router manufacturer for information on optimum security practices.

NOTE

When you use the instrument along with an application on your smart device, we recommend that you first set “Airplane Mode” to “ON,” and then set “Wi-Fi” to “ON” on your smart device in order to avoid noise caused by communication.

Connecting to a Computer ([USB TO HOST] terminal)

By connecting a computer to the [USB TO HOST] terminal, you can transfer data between the instrument and the computer via MIDI. For details on using a computer with this instrument, refer to the “Computer-related Operations” section on the website.

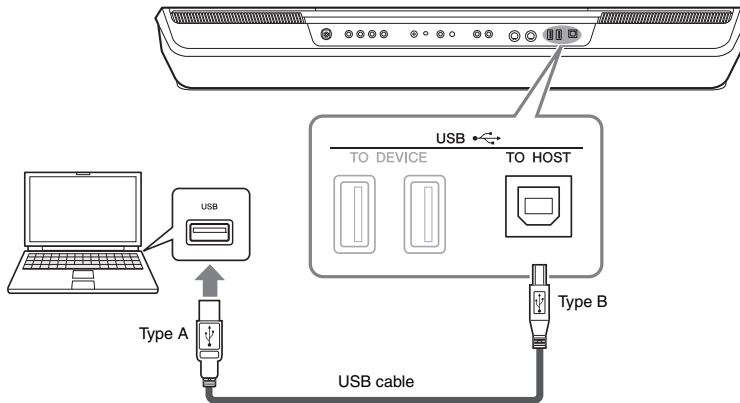

NOTICE

Use an AB type USB cable of less than 3 meters. USB 3.0 cables cannot be used.

NOTE

- When using a USB cable to connect the instrument to your computer, make the connection directly without passing through a USB hub.
- The instrument will begin transmission a short time after the USB connection is made.
- For information on setting up your sequence software, refer to the owner's manual of the relevant software.

Connecting External MIDI Devices (MIDI terminals)

Use the [MIDI] terminals and standard MIDI cables to connect external MIDI devices (keyboard, sequencer, etc.).

- **MIDI IN**.....Receives MIDI messages from another MIDI device.
- **MIDI OUT**.....Transmits MIDI messages generated by the instrument to another MIDI device.

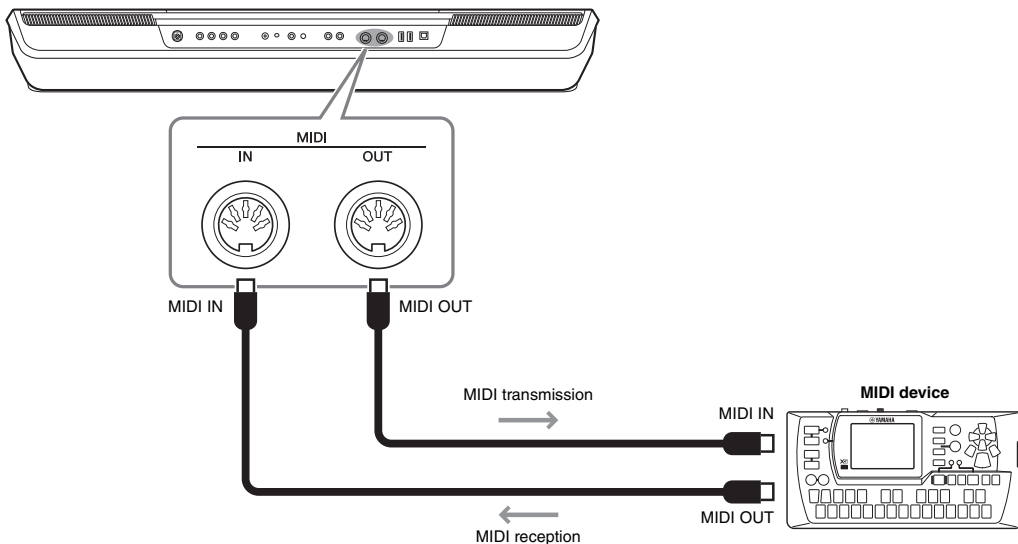

The MIDI settings such as transmit/receive channels on the instrument can be set via [MENU] → [MIDI]. For details, refer to the Reference Manual on the website.

NOTE

For a general overview of MIDI and how you can effectively use it, refer to “MIDI Basics,” which is downloadable from the website.

Function List

This section simply and very briefly explains what you can do in the displays called up by pressing the buttons on the panel, or by touching each icon on the Menu display.

For more information, refer to the page indicated below or the Reference manual on the website.

The “●” mark indicates that corresponding detailed information is described in the Reference Manual.

Displays accessible by the panel buttons

Display	Button to access	Description	Pages	Reference Manual
Home	[DIRECT ACCESS] + [EXIT]	Portal of the instrument's display structure, which provides at-a-glance information on all current settings.	26	-
Menu	[MENU]	By touching each of the icons, you can call up the menus for the various functions listed below.	29	-
Style Selection	STYLE category selection buttons	For selecting Style files.	40	-
Song Playback	SONG [PLAYER]	For controlling Song playback.	66, 70	●
Playlist	[PLAYLIST]	For selecting and editing Playlists, and managing your repertoire.	93	●
Song Recording	SONG [RECORDING]	For recording your performance.	87	●
Mixer	[MIXER/EQ]	For adjusting the parameters of each part, such as volume, pan, and EQ. It also allows you to adjust overall sound controls, such as Master Compressor and Master EQ.	83	●
Voice Selection	PART SELECT [LEFT]–[RIGHT 3], VOICE category selection buttons	For assigning Voices to each of the keyboard parts.	48	●
Multi Pad Selection	MULTI PAD CONTROL [SELECT]	For selecting Multi Pads.	53	●
Registration Memory Bank Selection	REGIST BANK SELECT [-]/[+]	For selecting Registration Memory Banks.	91	●
Registration Memory window	[MEMORY]	For registering the current panel settings.	90	-
Mic Setting	[MIC SETTING]	For making settings for the microphone and guitar sound.	104	●

Menu display functions

Menu	Description	Pages	Reference Manual
Mixer	For adjusting the parameters of each part, such as volume, pan, and EQ. It also allows you to adjust overall sound controls, such as Master Compressor and Master EQ.	83	●
Channel On/Off	For turning on and off each channel of the Style, and MIDI Song.	-	●
Voice Part Setup	For making detailed settings such as Voice Edit and Effect settings of the keyboard parts.	-	●
Line Out	Determines which jack is used to output each part and each drum & percussion instrument.	-	●
Score	For displaying the music notation (score) of the current MIDI Song.	75	●
Lyrics	For displaying the lyrics of the current Song.	76	●
Text Viewer	For displaying text files created on your computer.	-	●
Chord Looper	For recording a sequence of the chords and playing it back in a loop.	60	●
Kbd Harmony/Arp	For adding the Harmony/Arpeggio effect to the right-hand section of the keyboard. Parameters such as Harmony/Arpeggio type can be set.	50	●
Split & Fingering	For setting the Split Point or change the Chord Fingering type and Chord Detection area.	42, 45, 47	●
Mic Setting	For making settings for the microphone and guitar sound.	104	●
Regist Sequence	Determines the order for calling up Registration Memory settings when using a pedal.	-	●
Regist Freeze	Determines the item(s) that remain unchanged even when you call up panel setups from the Registration Memory.	-	●
Tempo	For adjusting the tempo of MIDI Song, Style or Metronome. The same operation as using Tempo [-]/[+] and [RESET/TAP TEMPO] buttons can be done on the display.	42	●

Menu	Description	Pages	Reference Manual
Metronome	For making settings of the metronome and the [RESET/TAP TEMPO] button.	37	●
Live Control	Determines the functions assigned to the LIVE CONTROL knobs and joystick.	56	●
Assignable	Determines the functions assigned to the pedals, assignable buttons, and the shortcuts on the Home display.	57, 97	●
Panel Lock	For locking the panel settings. When the panel settings are locked, nothing happens even when pressing any panel buttons.	37	-
Demo	For calling up the Demo display.	32	-
Voice Edit	For editing the preset Voices to create your own Voices. The display differs depending on whether an Organ Flutes Voice or another kind of Voice is selected.	-	●
Style Creator	For creating a Style by editing the preset Style, or by recording Style channels one by one.	-	●
Song Recording	For recording your performance. (This is same as the [RECORDING] button on the panel.)	87	●
M.Pad Creator	For creating a Multi Pad by editing an existing preset Multi Pad, or by recording a new one.	-	●
Voice Setting	Determines the detailed settings of the keyboard parts, such as the pitch for each part, and Voice Set filter.	-	●
Style Setting	For making Style playback related settings such as OTS Link timing, Dynamics Control, etc.	-	●
Song Setting	For making Song playback related settings such as Guide function, Channel settings, etc.	-	●
Chord Tutor	Indicates how to play chords that correspond to the specified chord names.	-	●
Scale Tune	For adjusting scales to play music you want to play.	78	●
Master Tune	For fine-tuning the pitch of the entire instrument.	-	●
Transpose	For transposing the pitch of the entire sound in semitones, or just the sound of the keyboard or MIDI Song.	55	●
Keyboard	Determines the Touch Response of the keyboard.	-	●
MIDI	For making MIDI-related settings.	-	●
Utility	For making global settings, managing the USB flash drives, initializing the instrument to the factory default, or backing up the data stored in the instrument, etc.	98	●
Expansion	For installing Expansion Packs for adding extra contents downloaded from the website or created on your own by using the Yamaha Expansion Manager.	-	●
Wireless LAN*	For making settings for connecting the instrument to a smart device via the wireless LAN function.	-	●
Time*	For making settings of the time shown on the display.	-	●

* This icon appears only when the optional USB Wireless LAN adaptor is connected.

Direct Access Chart

Press the [DIRECT ACCESS] button, and then press one of the buttons (or move the appropriate knob, joystick or pedal) listed below to call up the desired display.

Control		Display called up with the Direct Access Function			
SONG	[PLAYER]	Menu	Song Setting	-	-
	[RECORDING]			Guide	-
MIDI SONG	[PLAY/PAUSE]	Menu	Score	-	-
	[PREV]			Lyrics	-
	[NEXT]			Text Viewer	-
AUDIO SONG	[PLAY/PAUSE]	Menu	Song Setting	Part Ch	-
	[PREV]			Lyrics	-
	[NEXT]			Play	-
STYLE	Category Selection Button 1	Menu	Mixer	Filter	Style 1
	Category Selection Button 2			EQ	
	Category Selection Button 3			Effect	
	Category Selection Button 4			Chorus/Reverb	
	Category Selection Button 5			Pan/Volume	
	Category Selection Button 6				
	Category Selection Button 7				
	Category Selection Button 8				
	Category Selection Button 9				
	Category Selection Button 10				
LIVE CONTROL	[ASSIGN] Knob 1-2	Menu	Live Control	Knob	-
TRANPOSE	[-]/[+]	Menu	Transpose	-	-
TEMPO	[-]	Menu	Tempo	-	-
	[+]		Metronome	Metronome	-
[RESET/TAP TEMPO]		Menu	Metronome	Tap Tempo	-
[MIXER/EQ]		Menu	Channel On/Off	-	-
CHORD LOOPER	[REC/STOP]	Menu	Chord Looper	-	-
	[ON/OFF]				
DIRECT ACCESS		-	-	-	-
ASSIGNABLE Button	[A]-[F]	Menu	Assignable	-	-
ASSIGNABLE FOOT PEDAL	[1]-[2]	Menu	Assignable	-	-
[MIC SETTING]		Mic Setting Selection	-	-	-
[MENU]		Menu	Utility	-	-
[PLAYLIST]		Playlist Selection	-	-	-
Data Dial		-	-	-	-
[DEC]		-	-	-	-
[INC]		-	-	-	-
[EXIT]		Home	-	-	-
[ENTER]		Menu	Scale Tune	-	-
VOICE	Category Selection Button 1	Menu	Mixer	Filter	Panel 1
	Category Selection Button 2			EQ	
	Category Selection Button 3			Effect	
	Category Selection Button 4			Chorus/Reverb	
	Category Selection Button 5			Pan/Volume	
	Category Selection Button 6				
	Category Selection Button 7				
	Category Selection Button 8				
	Category Selection Button 9				
	Category Selection Button 10				
	Category Selection Button 11				
	Category Selection Button 12				
	[HARMONY/ARPEGGIO]				
	[SUSTAIN]				
	PART SELECT [LEFT]-[RIGHT 3]				
	PART ON/OFF [LEFT HOLD]				
	PART ON/OFF [LEFT]				
PART ON/OFF [RIGHT 1]					
PART ON/OFF [RIGHT 2]					
PART ON/OFF [RIGHT 3]					
			Voice Part Setup	-	-
			Expansion	-	-
			Keyboard Harmony/Arpeggio	-	-
			Voice Edit	Common 1	Page 2
			Voice Setting	Voice Set Filter	-
			Split Point & Fingering	-	-
			Voice Edit	-	Left
					Right 1
					Right 2
					Right 3

Control		Display called up with the Direct Access Function					
SCALE TUNE SETTING	[C]-[B]	Menu	Scale Tune	-	-		
SCALE TUNE MEMORY	[MEMORY]	Scale Tune Memory Bank Selection	-	-	-		
	[1]-[5]	(Scale Tune Memory Bank Selection)	Scale Tune Memory Bank Edit	-	-		
[BYPASS]		Menu	Scale Tune	-	-		
Joystick	[JOYSTICK HOLD]						
	Joystick X (+)	Menu	Live Control	Joystick	-		
	Joystick X (-)						
	Joystick Y (+)						
	Joystick Y (-)						
[STYLE TEMPO LOCK/ASSIGNABLE]	Menu	Assignable	-	-			
STYLE CONTROL	[ACMP]	Menu	Mixer	Split Point & Fingering	-	-	
	[AUTO FILL IN]			Style Setting	Setting	-	
	[OTS LINK]			EQ	Multi Pad		
	INTRO [I]					Chorus/Reverb	
	INTRO [II]					Pan/Volume	
	INTRO [III]				Compressor EQ	Master	
	MAIN VARIATION [A]			Style Setting	Change Behavior	-	
	MAIN VARIATION [B]				Setting	-	
	MAIN VARIATION [C]				Split Point & Fingering	-	
	MAIN VARIATION [D]				Setting	-	
	[BREAK]						
	ENDING/rit. [I]-[III]						
	[SYNC STOP]						
	[SYNC START]						
	[START/STOP]						
	REGISTRATION MEMORY			REGIST BANK [-]/[+]	(Registration Memory Bank Selection)	Regist Bank Edit	-
[FREEZE]		Menu	Registration Freeze	-	-		
[MEMORY]			Registration Sequence	-	-		
[1]-[4]		(Registration Memory Bank Selection)	Regist Bank Information	Voice	-		
ONE TOUCH SETTING	[1]-[4]	(Style Selection)	Style Information	-	-		
MULTI PAD CONTROL	[SELECT]	(Multi Pad Selection)	Multi Pad Edit	-	-		
	[1]						
	[2]						
	[3]						
	[4]						
[STOP]		Audio Link Multi Pad	-	-			
UPPER OCTAVE	[-]/[+]	Menu	Voice Setting	Tune	-		

Troubleshooting

Overall	
A click or pop is heard when the power is turned on or off.	This is normal. Electrical current is being applied to the instrument.
The power is automatically turned off.	This is normal and due to the Auto Power Off function. If necessary, set the parameter of the Auto Power Off function (page 21).
Noise is heard from the instrument.	Noise may be heard if a mobile phone is used near the instrument or if the phone is ringing. Turn off the mobile phone, or use it further away from the instrument.
Noise is heard from the instrument's speakers or headphones when using the instrument with the application on a smart device.	When you use the instrument along with the application on your smart device, we recommend that you set "Airplane Mode" to "ON" on your smart device in order to avoid noise caused by communication.
In the LCD, there are some specific points that are always lit or unlit.	These are the result of defective pixels and occasionally occur in TFT-LCDs; they do not indicate a problem in operation.
There is a slight difference in sound quality among different notes played on the keyboard.	This is normal and is a result of the instrument's sampling system.
Some Voices have a looping sound.	
Some noise or vibrato is noticeable at higher pitches, depending upon the Voice.	
The overall volume is too low, or, no sound is heard.	The master volume may be set too low. Set it to an appropriate level with the [MASTER VOLUME] dial.
	All keyboard parts are set to off. Use the PART ON/OFF [RIGHT 1]/[RIGHT 2]/[RIGHT 3]/[LEFT] button to turn it on (page 44).
	The volume of individual parts may be set too low. Raise the volume in the Mixer display (page 83).
	Make sure the desired channel is set to on in the Mixer display (page 85).
	Headphones are connected, disabling the speaker output. Unplug the headphones.
	Connect the footswitch to the appropriate jack.
The sound is distorted or noisy.	Make sure that the Speaker setting is set to "On" or "Headphone switch": [MENU] → [Utility]
	The volume may be turned up too high. Make sure all relevant volume settings are appropriate.
Sound from the speaker is occasionally interrupted.	This may be caused by certain effects or filter resonance settings. Check the effect or filter settings and change them accordingly in the Mixer display, referring to the Reference Manual on the website.
	The sound level is too high, so the speaker protection function is activated and the sound stops. Set the sound to an appropriate level by turning down the [MASTER VOLUME] dial.
Not all simultaneously played notes sound.	You are probably exceeding the maximum polyphony of the instrument. When the maximum polyphony is exceeded, the least important notes (such as soft notes and notes currently decaying) will stop sounding first.
The keyboard volume is lower than the Style/Song playback volume.	The volume of the keyboard parts may be set too low. Raise the volume in the Mixer display (page 83).
The Main display does not appear even when turning the power on.	This may occur if a USB flash drive has been installed to the instrument. Installation of some USB flash drives may result in a long interval between turning the power on and appearance of the Home display. To avoid this, turn the power on after disconnecting the device.
Some characters of the file/folder name are garbled.	The language settings have been changed. Set the appropriate language for the file/ folder names (page 21).
An existing file is not shown.	The file extension (.MID, etc.) may have been changed or deleted. Manually rename the file on a computer, adding the appropriate extension.
	Data files with names of more than 50 characters cannot be handled by the instrument. Rename the file, reducing the number of characters to 50 or less.

Style	
The Style does not start even when the [START/STOP] button is pressed.	The Rhythm channel of the selected Style may not contain any data. Turn the [ACMP] button on and play the left-hand section on the keyboard to sound the accompaniment part of the Style.
Only the rhythm channel plays.	Make sure the Auto Accompaniment function is turned on; press the [ACMP] button.
	Make sure to play keys in the chord section of the keyboard (pages 45, 47).
Styles in a USB flash drive cannot be selected.	If the size of the Style data is large (about 540 KB or greater), the Style cannot be selected because the data is too large to be read by the instrument.
Style playback seems to “skip” when the keyboard is played.	You are probably exceeding the maximum polyphony of the instrument. The instrument can play up to 128 notes at the same time—including RIGHT 1/RIGHT 2/RIGHT 3/ LEFT Voices, Style, Song, and Multi Pad notes. When the maximum polyphony is exceeded, the least important notes (such as soft notes and notes currently decaying) will stop sounding first.
Style does not change even when a different chord is played, or the chord is not recognized.	Make sure to play notes on the chord section of the keyboard (pages 45, 47).
Voice	
The Voice selected from the Voice Selection display does not sound.	Check whether the selected part is turned on or not (page 44).
A strange “flanging” or “doubling” sound occurs. The sound is slightly different each time the keys are played.	The RIGHT 1, RIGHT 2 and/or RIGHT 3 parts are set to “ON,” and the parts are set to play the same Voice. Turn “ON” only one of the parts or set different Voices for the parts.
The sound is slightly different each time the keys are played.	If you are routing the MIDI OUT on the instrument to a sequencer and back to the MIDI IN, you may need to set Local Control setting to “off” in the System page of the MIDI display (refer to the Reference Manual on the website).
Some Voices will jump an octave in pitch when played in the upper or lower registers.	This is normal. Some voices have a pitch limit which, when reached, causes this type of pitch shift.
Song	
MIDI Songs cannot be selected.	If the size of the Song data is large (about 3 MB or greater), the Song cannot be selected because the data is too large to be read by the instrument.
	MIDI Songs cannot be played back during MIDI recording operation. Stop MIDI Recording when you want to play back a MIDI Song.
Audio Songs cannot be selected.	The file format may not be compatible with the instrument. Compatible formats are: MP3 and WAV. DRM protected files cannot be played back.
Song playback does not start.	The Song has been stopped at the end of the Song data. Return to the beginning of the Song by pressing the SONG [◀◀] (PREV) button of corresponding Song type (MIDI or AUDIO).
(MIDI) The measure number is different from that of the score in the Song Position display, shown by pressing and holding the [◀◀] (PREV) or [▶▶] (NEXT) button.	This happens when playing back music data for which a specific, fixed tempo is set.
(MIDI) When playing back a Song, some channels do not play.	Playback of these channels may be set to off. Turn playback on for those channels that are set to off (page 85).
(MIDI) The tempo, beat, measure and music notation are not displayed correctly.	Some Song data for the instrument has been recorded with special “free tempo” settings. For such Song data, the tempo, beat, measure and music notation will not be displayed correctly.
(MIDI) When viewing the lyrics on the Score display, some lyrics are omitted and cannot be seen.	There is not enough space to show the lyrics. Change the size of the Score to other than “Medium” via the View Setting (page 75).
(Audio) Recorded file is played back at a different volume compared to when it was recorded.	The audio playback volume has been changed. Setting the volume value to 90 plays back the file at the same volume as when it was recorded (page 83).
In the Audio Recording function, an error message appears and audio cannot be recorded to the internal User drive.	The data on the User drive is fragmented and cannot be used as is. Since there is no defragmentation function in Audio Recording, the drive can only be defragmented by formatting it. To do this, first back up the data by using the data backup function (page 102), format the drive, and then finally restore the backup data. Performing this backup/restore operation effectively defragments the drive, allowing you to use it again.

In the Audio Recording function, an error message appears and audio cannot be recorded to the USB flash drive.	Make sure to use a compatible USB flash drive.
	The USB flash drive may not have enough free space. Check the available space on the display called up via [MENU] → [Utility] → [Storage]. (page 109)
	If you are using a USB flash drive to which data has already been recorded, check first that no important data remains on the drive, format it (page 109), and then try recording again.
Mixer	
The sound seems strange or different than expected when changing a rhythm Voice (drum kit, etc.) of the Style or Song from the Mixer.	When changing the rhythm/percussion Voices (drum kits, etc.) of the Style and Song from the VOICE parameter, the detailed settings related to the drum voice are reset, and in some cases you may be unable to restore the original sound. You can restore the original sound by selecting the same Style or Song again.
Microphone, Guitar	
The microphone or guitar input signal cannot be recorded.	The microphone or guitar input signal cannot be recorded by MIDI recording. Record by using Audio recording (page 88).
FOOT PEDAL jacks	
The on/off setting of the footswitch connected to the ASSIGNABLE FOOT PEDAL jack is reversed.	Turn the instrument's power off, and then turn it on again making sure not to press the foot-switch.
Connections	
Sound input to the AUX IN jacks is interrupted.	The output volume of the external device connected to this instrument is too low. Increase the output volume of the external device. The volume level reproduced via this instrument can be adjusted by using the [MASTER VOLUME] dial.
The Wireless LAN and Time icons are not shown in the Menu display even though the USB wireless LAN adaptor is connected.	Disconnect the USB wireless LAN adaptor and connect it again.

Specifications

Product Name		Digital Keyboard		
Size/Weight	Dimensions (W x D x H)		1,017 mm x 431 mm x 139 mm (40-1/16" x 17" x 5-1/2")	
	Weight		11.5 kg (25 lb, 6 oz)	
Control Interface	Keyboard	Number of Keys	61	
		Type	Organ (FSB), Initial Touch	
		Touch Response	Normal, Soft 1, Soft 2, Hard 1, Hard 2	
	Other Controllers	Joystick	Yes (Assignable)	
		Knobs	2 (Assignable)	
		Assignable Buttons	7	
		Scale Tune Memory Buttons	5	
		Scale Tune Setting Buttons	Yes	
	Display	Type	TFT Color Wide VGA LCD	
		Size	800 x 480 dots 7 inch	
		Touch Screen	Yes	
Language		English, German, French, Spanish, Italian		
Panel	Language	English		
Voices	Tone Generation	Tone Generation Technology	AWM Stereo Sampling	
	Polyphony		128 (max.)	
	Preset	Number of Voices	1,161 Voices + 86 Drum/SFX Kits + 480 XG Voices	
		Featured Voices	219 S.Art!, 25 MegaVoice, 41 Sweet!, 64 Cool!, 91 Live!, 24 OrganFlutes, 20 Revo!SFX (including 299 Oriental Voices, 44 Oriental Drum Kits)	
	Compatibility		XG (for Song playback), GS (for Song playback), GM, GM2	
Effects	Types	Keyboard Part	Right 1, Right 2, Right 3, Left	
		Reverb	59 Presets + 30 User	
		Chorus	106 Presets + 30 User	
		Variation Effect	322 Presets (with VCM) + 30 User	
		Insertion Effect	1–8: 322 Preset (with VCM) + 30 User	
		Master Compressor	5 Presets + 30 User	
		Master EQ	5 Presets + 30 User	
		Part EQ	28 Parts	
		Others	Mic/Guitar Effects: Noise Gate, Compressor, 3 Band EQ	
		Styles	Preset	Number of Styles
Featured Styles	429 Pro, 15 Session, 10 DJ			
Fingering	Single Finger, Multi Finger, Fingered, Fingered On Bass, Full Keyboard, AI Fingered, AI Full Keyboard			
Style Control	INTRO x 3, MAIN VARIATION x 4, FILL IN x 4, BREAK, ENDING x 3			
One Touch Setting (OTS)	4 for each Style			
Chord Looper	Yes			
Style Section Reset	Yes			
Style Section Change Timing	Yes			
Style Section Time Signature	Yes			
Compatibility				Style File Format (SFF), Style File Format GE (SFF GE)
Expandability	Expansion Voice		Yes (approx. 1 GB)	
	Expansion Style		Yes (Internal Memory)	
	Expansion Audio Style		Yes (Internal Memory)	
Songs (MIDI)	Preset	Number of Preset Songs	3 Sample Songs	
	Recording	Number of Tracks	16	
		Data Capacity	approx. 3 MB per Song	
		Function	Quick Recording, Multi Track Recording, Step Recording	
	Format	Playback	SMF (Format 0 & 1), XF	
Recording		SMF (Format 0)		
Songs (Audio)	Recording	Data Capacity	approx. 0.8 GB (80 minutes) per Song	
	Format	Playback	WAV (44.1 kHz, 16 bit, stereo), MP3 (44.1/48.0 kHz, 64–320 kbps and VBR, mono/stereo)	
		Recording	WAV (44.1 kHz, 16 bit, stereo), MP3 (44.1 kHz, 128/256/320 kbps, stereo)	
	Time Stretch		Yes	
	Pitch Shift		Yes	
	Vocal Cancel		Yes	
	Multi Pads	Number of Multi Pad Banks		257 banks x 4 Pads
Audio Link		Yes		

Functions	Voices	Harmony	Yes
		Arpeggio	Yes
		Panel Sustain	Yes
		Mono/Poly	Yes
	Styles	Style Creator	Yes
		OTS Information	Yes
	Songs	Score Display Function	Yes
		Lyrics Display Function	Yes
		Guide	Follow Lights, Any Key, Karao-Key, Your Tempo
	Multi Pads	Multi Pad Creator	Yes
	Registration Memory	Number of Buttons	8
		Control	Registration Sequence, Freeze
	Playlist	Number of Records	2,500 (max.) Records per Playlist file
	Search		Yes
	Demo		Yes
	Overall Controls	Metronome	Yes
		Tempo Range	5 – 500, Tap Tempo
		Transpose	-12 – 0 – +12
		Tuning	414.8 – 440 – 466.8 Hz
		Upper Octave	-3 – 0 – +3
Scale Type		12 types	
Sub Scale Setting		Yes	
Scale Tune Memory		5	
Miscellaneous	Direct Access	Yes	
	Text Display Function	Yes	
	Wallpaper Customization	Yes	
Storage and Connectivity	Storage	Internal Memory (USER Drive)	Yes (approx. 2 GB)
		External Drives	USB flash drive
	Connectivity	DC IN	16 V
		Headphones	Standard stereo phone jack
		Microphone/Guitar	Yes
		MIDI	IN, OUT
		AUX IN	Stereo mini jack
		LINE OUT	MAIN OUTPUT (L/L+R, R), SUB (AUX) OUTPUT (1,2 (L/L+R, R))
		FOOT PEDAL	2 (Assignable)
		USB TO DEVICE	Yes (x 2)
USB TO HOST	Yes		
Sound System	Amplifiers	15 W x 2	
	Speakers	13 cm x 2 + 5 cm x 2	
Power Supply	AC Adaptor	PA-300C (Output: DC 16 V, 2.4 A) or an equivalent recommended by Yamaha	
	Power Consumption	24 W	
	Auto Power Off	Yes	
Included Accessories		Owner's Manual (this book) Online Member Product Registration Music rest AC adaptor* (PA-300C or an equivalent recommended by Yamaha) * May not be included depending on your area. Check with your Yamaha dealer.	
Separately Sold Accessories (May not be available depending on your area.)		AC adaptor: PA-300C or an equivalent recommended by Yamaha Headphones: HPH-50, HPH-100, HPH-150 Footswitch: FC4A, FC5 Foot controller: FC7 USB wireless LAN adaptor: UD-WL01 Wireless MIDI adaptor: UD-BT01, MD-BT01 Subwoofer: KS-SW100 Keyboard stand: L-6, L-7B (The exterior size of the PSR-A5000 is beyond the limits as described in the L-6 Assembly Instructions. However, we have determined through tests that the stand can be safely used for the instrument.)	

* The contents of this manual apply to the latest specifications as of the publishing date. To obtain the latest manual, access the Yamaha website then download the manual file. Since specifications, equipment or separately sold accessories may not be the same in every locale, please check with your Yamaha dealer.

Index

A			
A-B Repeat	72		
AC adaptor	20		
Accessories	8		
Accompaniment	40		
Action (Playlist)	94		
AI Full Keyboard	42		
Arpeggio	51		
ASSIGNABLE	57, 97		
Audio Link Multi Pad	53		
Audio Phraser	11		
Audio Song	66		
Auto Power Off	21		
AUX IN	106		
B			
Backup	102		
Break (Style)	60		
Button Lamps	22, 23		
C			
Channel (Style, MIDI Song)	85		
Character Entry	36		
Chord Cancel	42		
Chord Detection Area	47		
Chord Fingering type	42		
Chord Looper	60		
Chord Match	64		
Chorus	84		
Close	29		
Compressor	99		
Computer	11, 110		
Computer-related Operations	9, 11		
Connection	103		
Copy	34		
D			
Data Dial	31		
Data List	9		
Delete	35		
Demo	32		
Direct Access	32, 113		
DJ Style	41		
Drums/SFX Voice	48		
E			
Effect	84		
Ending (Style)	58		
EQ (for each part)	84		
EQ (Master EQ)	99		
Expansion Packs	100		
F			
Factory Reset	101		
Fade In/Out	59		
Fast Forward	70		
Favorite	28, 35		
File	28, 33		
File Selection Display	28		
Fill-in (Style)	59		
Filter	84		
Fingered	42		
Fingering type	42		
Firmware Version	101		
Folder	34		
Foot Controller	57, 107		
Footage	49		
Footswitch	57, 107		
Format	109		
Function	111		
G			
GM	8		
GS	8		
Guitar	14, 103		
H			
Hardware ID	101		
Harmony (Keyboard Harmony)	50		
Headphones	19		
Home Display	23, 26		
I			
Intro (Style)	58		
J			
Joystick	62		
Joystick Assign Type	56		
JOYSTICK HOLD	62		
K			
Keyboard Harmony	50		
Keyboard Part	14, 44		
Knob Assign Type	56		
L			
Language	21		
Layer	44		
LEFT	44		
Left Hold	45		
LIVE CONTROL joystick	56		
LIVE CONTROL knobs	56		
Loop Playback	74		
LOWER	44		
Lyrics	76		
M			
Main (Style)	59		
Main Display	22, 23		
Main Scale	79		
Manual Bass	47		
Master Compressor	99		
Master EQ	99		
Menu	29, 111		
Metronome	37		
Mic	14		
Mic Setting	104		
Microphone	77, 103		
MIDI	109, 110		
MIDI Song	66		
Mixer	83		
Modulation	62		
Move	34		
MP3	67, 87		
Multi Pad	14, 53, 64		
Music Notation	75		
Music Rest	18		
N			
Next	70		
O			
One Touch Setting	43, 54		
Organ Flutes Voice	49		
OTS Link	59		
OUTPUT	105		
Owner name	21		
P			
Pan	84		
Panel Lock	37		
Panel Setup (Panel Settings)	18, 38		
Parameter Lock	98		
Phrase Mark	71		
Pitch Bend	62		
Pitch Shift	72		
Play/Pause	70		
Playback (Multi Pad)	64		
Playback (Song)	70		
Playback (Style)	58		
Playlist	15, 89, 93		
Playlist Record	89, 94		
Power	20		
Preset	28		
Previous	70		

R

Record Name (Playlist).....	94
Recording	15, 87
Reference Manual	9, 10
Regist Bank Edit	92
Regist Bank Info	92
Registration Memory.....	15, 89
Registration Memory Bank.....	27, 89
Registration Sequence	27
Rename	34
RESET	42
Restore	102
Reverb	84
Rewind.....	70
RIGHT.....	44

S

S.Art (Super Articulation) Voice ...	48, 63
Save.....	33
Scale Tune.....	15, 78
SCALE TUNE MEMORY	81
Scale Tune Memory Bank.....	82
Score	75
Search	35
Section.....	59
SFF (Style File Format).....	8, 41
Shortcut	27, 97
Smart Device Connection Manual.....	9, 11
Song	14, 66, 70
Song File Compatibility	67
Song List.....	14, 67, 69, 70
Song Player	14, 67, 68, 70
Song Position.....	71
Song Position Marker	71, 73
Specifications.....	118
Split.....	44
Split Point.....	44, 45
Style.....	14, 40, 58
Style Section Reset	59
STYLE TEMPO LOCK/ ASSIGNABLE.....	57
Sub Scale	80
Sustain.....	62
Synchro Start (MIDI Song).....	71
Synchro Start (Multi Pad).....	65
Synchro Start (Style).....	58
Synchro Stop (Style).....	58

T

Talk.....	77
TAP TEMPO	42
TEMPO	42
Text.....	76
Time Stretch	72
Touch Screen	30
TRANSPOSE.....	55
Troubleshooting	115
Tuning.....	55, 79

U

UPPER.....	44
UPPER OCTAVE	55
USB flash drive	108, 109
USB wireless LAN adaptor....	108, 109
User.....	28

V

Vocal Cancel	72
Voice	14, 48, 86
Volume (for each part)	84
Volume (Master volume)	20

W

WAV	67, 87
Website	9

X

XF.....	8
XG.....	8

Y

Yamaha Expansion Manager..	11, 100
----------------------------	---------

GNU GENERAL PUBLIC LICENSE

Version 2, June 1991

Copyright © 1989, 1991 Free Software Foundation, Inc., 51 Franklin Street, Fifth Floor, Boston, MA 02110-1301 USA
Everyone is permitted to copy and distribute verbatim copies of this license document, but changing it is not allowed.

Preamble

The licenses for most software are designed to take away your freedom to share and change it. By contrast, the GNU General Public License is intended to guarantee your freedom to share and change free software—to make sure the software is free for all its users. This General Public License applies to most of the Free Software Foundation's software and to any other program whose authors commit to using it. (Some other Free Software Foundation software is covered by the GNU Lesser General Public License instead.) You can apply it to your programs, too.

When we speak of free software, we are referring to freedom, not price. Our General Public Licenses are designed to make sure that you have the freedom to distribute copies of free software (and charge for this service if you wish), that you receive source code or can get it if you want it, that you can change the software or use pieces of it in new free programs; and that you know you can do these things.

To protect your rights, we need to make restrictions that forbid anyone to deny you these rights or to ask you to surrender the rights. These restrictions translate to certain responsibilities for you if you distribute copies of the software, or if you modify it.

For example, if you distribute copies of such a program, whether gratis or for a fee, you must give the recipients all the rights that you have. You must make sure that they, too, receive or can get the source code. And you must show them these terms so they know their rights.

We protect your rights with two steps: (1) copyright the software, and (2) offer you this license which gives you legal permission to copy, distribute and/or modify the software.

Also, for each author's protection and ours, we want to make certain that everyone understands that there is no warranty for this free software. If the software is modified by someone else and passed on, we want its recipients to know that what they have is not the original, so that any problems introduced by others will not reflect on the original authors' reputations.

Finally, any free program is threatened constantly by software patents. We wish to avoid the danger that redistributors of a free program will individually obtain patent licenses, in effect making the program proprietary. To prevent this, we have made it clear that any patent must be licensed for everyone's free use or not licensed at all.

The precise terms and conditions for copying, distribution and modification follow.

GNU GENERAL PUBLIC LICENSE TERMS AND CONDITIONS FOR COPYING, DISTRIBUTION AND MODIFICATION

0. This License applies to any program or other work which contains a notice placed by the copyright holder saying it may be distributed under the terms of this General Public License. The "Program," below, refers to any such program or work, and a "work based on the Program" means either the Program or any derivative work under copyright law: that is to say, a work containing the Program or a portion of it, either verbatim or with modifications and/or translated into another language. (Hereinafter, translation is included without limitation in the term "modification.") Each licensee is addressed as "you".

Activities other than copying, distribution and modification are not covered by this License; they are outside its scope. The act of running the Program is not restricted, and the output from the Program is covered only if its contents constitute a work based on the Program (independent of having been made by running the Program). Whether that is true depends on what the Program does.

1. You may copy and distribute verbatim copies of the Program's source code as you receive it, in any medium, provided that you conspicuously and appropriately publish on each copy an appropriate copyright notice and disclaimer of warranty; keep intact all the notices that refer to this License and to the absence of any warranty; and give any other recipients of the Program a copy of this License along with the Program.

You may charge a fee for the physical act of transferring a copy, and you may at your option offer warranty protection in exchange for a fee.

2. You may modify your copy or copies of the Program or any portion of it, thus forming a work based on the Program, and copy and distribute such modifications or work under the terms of Section 1 above, provided that you also meet all of these conditions:

- a)** You must cause the modified files to carry prominent notices stating that you changed the files and the date of any change.
- b)** You must cause any work that you distribute or publish, that in whole or in part contains or is derived from the Program or any part thereof, to be licensed as a whole at no charge to all third parties under the terms of this License.
- c)** If the modified program normally reads commands interactively when run, you must cause it, when started running for such interactive use in the most ordinary way, to print or display an announcement including an appropriate copyright notice and a notice that there is no warranty (or else, saying that you provide a warranty) and that users may redistribute the program under these conditions, and telling the user how to view a copy of this License. (Exception: if the Program itself is interactive but does not normally print such an announcement, your work based on the Program is not required to print an announcement.)

These requirements apply to the modified work as a whole. If identifiable sections of that work are not derived from the Program, and can be reasonably considered independent and separate works in themselves, then this License, and its terms, do not apply to those sections when you distribute them as separate works. But when you distribute the same sections as part of a whole which is a work based on the Program, the distribution of the whole must be on the terms of this License, whose permissions for other licensees extend to the entire whole, and thus to each and every part regardless of who wrote it.

Thus, it is not the intent of this section to claim rights or contest your rights to work written entirely by you; rather, the intent is to exercise the right to control the distribution of derivative or collective works based on the Program.

In addition, mere aggregation of another work not based on the Program with the Program (or with a work based on the Program) on a volume of a storage or distribution medium does not bring the other work under the scope of this License.

3. You may copy and distribute the Program (or a work based on it, under Section 2) in object code or executable form under the terms of Sections 1 and 2 above provided that you also do one of the following:

- a)** Accompany it with the complete corresponding machine-readable source code, which must be distributed under the terms of Sections 1 and 2 above on a medium customarily used for software interchange; or,
- b)** Accompany it with a written offer, valid for at least three years, to give any third party, for a charge no more than your cost of physically performing source distribution, a complete machine-readable copy of the corresponding source code, to be distributed under the terms of Sections 1 and 2 above on a medium customarily used for software interchange; or,
- c)** Accompany it with the information you received as to the offer to distribute corresponding source code. (This alternative is allowed only for noncommercial distribution and only if you received the program in object code or executable form with such an offer, in accord with Subsection b above.)

The source code for a work means the preferred form of the work for making modifications to it. For an executable work, complete source code means all the source code for all modules it contains, plus any associated interface definition files, plus the scripts used to control compilation and installation of the executable. However, as a special exception, the source code distributed need not include anything that is normally distributed (in either source or binary form) with the major components (compiler, kernel, and so on) of the operating system on which the executable runs, unless that component itself accompanies the executable.

If distribution of executable or object code is made by offering access to copy from a designated place, then offering equivalent access to copy the source code from the same place counts as distribution of the source code, even though third parties are not compelled to copy the source along with the object code.

4. You may not copy, modify, sublicense, or distribute the Program except as expressly provided under this License. Any attempt otherwise to copy, modify, sublicense or distribute the Program is void, and will automatically terminate your rights under this License. However, parties who have received copies, or rights, from you under this License will not have their licenses terminated so long as such parties remain in full compliance.
5. You are not required to accept this License, since you have not signed it. However, nothing else grants you permission to modify or distribute the Program or its derivative works. These actions are prohibited by law if you do not accept this License. Therefore, by modifying or distributing the Program (or any work based on the Program), you indicate your acceptance of this License to do so, and all its terms and conditions for copying, distributing or modifying the Program or works based on it.
6. Each time you redistribute the Program (or any work based on the Program), the recipient automatically receives a license from the original licensor to copy, distribute or modify the Program subject to these terms and conditions. You may not impose any further restrictions on the recipients' exercise of the rights granted herein. You are not responsible for enforcing compliance by third parties to this License.
7. If, as a consequence of a court judgment or allegation of patent infringement or for any other reason (not limited to patent issues), conditions are imposed on you (whether by court order, agreement or otherwise) that contradict the conditions of this License, they do not excuse you from the conditions of this License. If you cannot distribute so as to satisfy simultaneously your obligations under this License and any other pertinent obligations, then as a consequence you may not distribute the Program at all. For example, if a patent license would not permit royalty-free redistribution of the Program by all those who receive copies directly or indirectly through you, then the only way you could satisfy both it and this License would be to refrain entirely from distribution of the Program.

If any portion of this section is held invalid or unenforceable under any particular circumstance, the balance of the section is intended to apply and the section as a whole is intended to apply in other circumstances.

It is not the purpose of this section to induce you to infringe any patents or other property right claims or to contest validity of any such claims; this section has the sole purpose of protecting the integrity of the free software distribution system, which is implemented by public license practices. Many people have made generous contributions to the wide range of software distributed through that system in reliance on consistent application of that system; it is up to the author/donor to decide if he or she is willing to distribute software through any other system and a licensee cannot impose that choice.

This section is intended to make thoroughly clear what is believed to be a consequence of the rest of this License.

8. If the distribution and/or use of the Program is restricted in certain countries either by patents or by copyrighted interfaces, the original copyright holder who places the Program under this License may add an explicit geographical distribution limitation excluding those countries, so that distribution is permitted only in or among countries not thus excluded. In such case, this License incorporates the limitation as if written in the body of this License.
9. The Free Software Foundation may publish revised and/or new versions of the General Public License from time to time. Such new versions will be similar in spirit to the present version, but may differ in detail to address new problems or concerns.

Each version is given a distinguishing version number. If the Program specifies a version number of this License which applies to it and "any later version", you have the option of following the terms and conditions either of that version or of any later version published by the Free Software Foundation. If the Program does not specify a version number of this License, you may choose any version ever published by the Free Software Foundation.
10. If you wish to incorporate parts of the Program into other free programs whose distribution conditions are different, write to the author to ask for permission. For software which is copyrighted by the Free Software Foundation, write to the Free Software Foundation; we sometimes make exceptions for this. Our decision will be guided by the two goals of preserving the free status of all derivatives of our free software and of promoting the sharing and reuse of software generally.

NO WARRANTY

11. BECAUSE THE PROGRAM IS LICENSED FREE OF CHARGE, THERE IS NO WARRANTY FOR THE PROGRAM, TO THE EXTENT PERMITTED BY APPLICABLE LAW. EXCEPT WHEN OTHERWISE STATED IN WRITING THE COPYRIGHT HOLDERS AND/OR OTHER PARTIES PROVIDE THE PROGRAM "AS IS" WITHOUT WARRANTY OF ANY KIND, EITHER EXPRESSED OR IMPLIED, INCLUDING, BUT

NOT LIMITED TO, THE IMPLIED WARRANTIES OF MERCHANTABILITY AND FITNESS FOR A PARTICULAR PURPOSE. THE ENTIRE RISK AS TO THE QUALITY AND PERFORMANCE OF THE PROGRAM IS WITH YOU. SHOULD THE PROGRAM PROVE DEFECTIVE, YOU ASSUME THE COST OF ALL NECESSARY SERVICING, REPAIR OR CORRECTION.

12. IN NO EVENT UNLESS REQUIRED BY APPLICABLE LAW OR AGREED TO IN WRITING WILL ANY COPYRIGHT HOLDER, OR ANY OTHER PARTY WHO MAY MODIFY AND/OR REDISTRIBUTE THE PROGRAM AS PERMITTED ABOVE, BE LIABLE TO YOU FOR DAMAGES, INCLUDING ANY GENERAL, SPECIAL, INCIDENTAL OR CONSEQUENTIAL DAMAGES ARISING OUT OF THE USE OR INABILITY TO USE THE PROGRAM (INCLUDING BUT NOT LIMITED TO LOSS OF DATA OR DATA BEING RENDERED INACCURATE OR LOSSES SUSTAINED BY YOU OR THIRD PARTIES OR A FAILURE OF THE PROGRAM TO OPERATE WITH ANY OTHER PROGRAMS), EVEN IF SUCH HOLDER OR OTHER PARTY HAS BEEN ADVISED OF THE POSSIBILITY OF SUCH DAMAGES.

END OF TERMS AND CONDITIONS

How to Apply These Terms to Your New Programs

If you develop a new program, and you want it to be of the greatest possible use to the public, the best way to achieve this is to make it free software which everyone can redistribute and change under these terms.

To do so, attach the following notices to the program. It is safest to attach them to the start of each source file to most effectively convey the exclusion of warranty; and each file should have at least the "copyright" line and a pointer to where the full notice is found.

<one line to give the program's name and a brief idea of what it does.>
Copyright © <year> <name of author>

This program is free software; you can redistribute it and/or modify it under the terms of the GNU General Public License as published by the Free Software Foundation; either version 2 of the License, or (at your option) any later version.

This program is distributed in the hope that it will be useful, but WITHOUT ANY WARRANTY; without even the implied warranty of MERCHANTABILITY or FITNESS FOR A PARTICULAR PURPOSE. See the GNU General Public License for more details.

You should have received a copy of the GNU General Public License along with this program; if not, write to the Free Software Foundation, Inc., 51 Franklin Street, Fifth Floor, Boston, MA 02110-1301 USA.

Also add information on how to contact you by electronic and paper mail.

If the program is interactive, make it output a short notice like this when it starts in an interactive mode:

Gnomovision version 69, Copyright © year name of author
Gnomovision comes with ABSOLUTELY NO WARRANTY; for details type 'show w'. This is free software, and you are welcome to redistribute it under certain conditions; type 'show c' for details.

The hypothetical commands 'show w' and 'show c' should show the appropriate parts of the General Public License. Of course, the commands you use may be called something other than 'show w' and 'show c'; they could even be mouse-clicks or menu items—whatever suits your program.

You should also get your employer (if you work as a programmer) or your school, if any, to sign a "copyright disclaimer" for the program, if necessary. Here is a sample; alter the names:

Yoyodyne, Inc., hereby disclaims all copyright interest in the program 'Gnomovision' (which makes passes at compilers) written by James Hacker.

<signature of Ty Coon>, 1 April 1989
Ty Coon, President of Vice

This General Public License does not permit incorporating your program into proprietary programs. If your program is a subroutine library, you may consider it more useful to permit linking proprietary applications with the library. If this is what you want to do, use the GNU Lesser General Public License instead of this License.

GNU LESSER GENERAL PUBLIC LICENSE

Version 2.1, February 1999

Copyright © 1991, 1999 Free Software Foundation, Inc., 51 Franklin Street, Fifth Floor, Boston, MA 02110-1301 USA
Everyone is permitted to copy and distribute verbatim copies of this license document, but changing it is not allowed.

[This is the first released version of the Lesser GPL.

It also counts as the successor of the GNU Library Public License, version 2, hence the version number 2.1.]

Preamble

The licenses for most software are designed to take away your freedom to share and change it. By contrast, the GNU General Public Licenses are intended to guarantee your freedom to share and change free software—to make sure the software is free for all its users.

This license, the Lesser General Public License, applies to some specially designated software packages—typically libraries—of the Free Software Foundation and other authors who decide to use it. You can use it too, but we suggest you first think carefully about whether this license or the ordinary General Public License is the better strategy to use in any particular case, based on the explanations below.

When we speak of free software, we are referring to freedom of use, not price. Our General Public Licenses are designed to make sure that you have the freedom to distribute copies of free software (and charge for this service if you wish); that you receive source code or can get it if you want it; that you can change the software and use pieces of it in new free programs; and that you are informed that you can do these things.

To protect your rights, we need to make restrictions that forbid distributors to deny you these rights or to ask you to surrender these rights. These restrictions translate to certain responsibilities for you if you distribute copies of the library or if you modify it.

For example, if you distribute copies of the library, whether gratis or for a fee, you must give the recipients all the rights that we gave you. You must make sure that they, too, receive or can get the source code. If you link other code with the library, you must provide complete object files to the recipients, so that they can relink them with the library after making changes to the library and recompiling it. And you must show them these terms so they know their rights.

We protect your rights with a two-step method: (1) we copyright the library, and (2) we offer you this license, which gives you legal permission to copy, distribute and/or modify the library.

To protect each distributor, we want to make it very clear that there is no warranty for the free library. Also, if the library is modified by someone else and passed on, the recipients should know that what they have is not the original version, so that the original author's reputation will not be affected by problems that might be introduced by others.

Finally, software patents pose a constant threat to the existence of any free program. We wish to make sure that a company cannot effectively restrict the users of a free program by obtaining a restrictive license from a patent holder. Therefore, we insist that any patent license obtained for a version of the library must be consistent with the full freedom of use specified in this license.

Most GNU software, including some libraries, is covered by the ordinary GNU General Public License. This license, the GNU Lesser General Public License, applies to certain designated libraries, and is quite different from the ordinary General Public License. We use this license for certain libraries in order to permit linking those libraries into non-free programs.

When a program is linked with a library, whether statically or using a shared library, the combination of the two is legally speaking a combined work, a derivative of the original library. The ordinary General Public License therefore permits such linking only if the entire combination fits its criteria of freedom. The Lesser General Public License permits more lax criteria for linking other code with the library.

We call this license the “Lesser” General Public License because it does Less to protect the user's freedom than the ordinary General Public License. It also provides other free software developers Less of an advantage over competing non-free programs. These disadvantages are the reason we use the ordinary General Public License for many libraries. However, the Lesser license provides advantages in certain special circumstances.

For example, on rare occasions, there may be a special need to encourage the widest possible use of a certain library, so that it becomes a de-facto standard. To achieve this, non-free programs must be allowed to use the library. A more frequent case is that a free library does the same job as widely used non-free libraries. In this case, there is little to gain by limiting the free library to free software only, so we use the Lesser General Public License.

In other cases, permission to use a particular library in non-free programs enables a greater number of people to use a large body of free software. For example, permission to use the GNU C Library in non-free programs enables many more people to use the whole GNU operating system, as well as its variant, the GNU/Linux operating system.

Although the Lesser General Public License is Less protective of the users' freedom, it does ensure that the user of a program that is linked with the Library has the freedom and the wherewithal to run that program using a modified version of the Library.

The precise terms and conditions for copying, distribution and modification follow. Pay close attention to the difference between a “work based on the library” and a “work that uses the library”. The former contains code derived from the library, whereas the latter must be combined with the library in order to run.

GNU LESSER GENERAL PUBLIC LICENSE TERMS AND CONDITIONS FOR COPYING, DISTRIBUTION AND MODIFICATION

0. This License Agreement applies to any software library or other program which contains a notice placed by the copyright holder or other authorized party saying it may be distributed under the terms of this Lesser General Public License (also called “this License”). Each licensee is addressed as “you”.

A “library” means a collection of software functions and/or data prepared so as to be conveniently linked with application programs (which use some of those functions and data) to form executables.

The “Library”, below, refers to any such software library or work which has been distributed under these terms. A “work based on the Library” means either the Library or any derivative work under copyright law: that is to say, a work containing the Library or a portion of it, either verbatim or with modifications and/or translated straightforwardly into another language. (Hereinafter, translation is included without limitation in the term “modification”.)

“Source code” for a work means the preferred form of the work for making modifications to it. For a library, complete source code means all the source code for all modules it contains, plus any associated interface definition files, plus the scripts used to control compilation and installation of the library.

Activities other than copying, distribution and modification are not covered by this License; they are outside its scope. The act of running a program using the Library is not restricted, and output from such a program is covered only if its contents constitute a work based on the Library (independent of the use of the Library in a tool for writing it). Whether that is true depends on what the Library does and what the program that uses the Library does.

1. You may copy and distribute verbatim copies of the Library's complete source code as you receive it, in any medium, provided that you conspicuously and appropriately publish on each copy an appropriate copyright notice and disclaimer of warranty; keep intact all the notices that refer to this License and to the absence of any warranty; and distribute a copy of this License along with the Library.

You may charge a fee for the physical act of transferring a copy, and you may at your option offer warranty protection in exchange for a fee.

2. You may modify your copy or copies of the Library or any portion of it, thus forming a work based on the Library, and copy and distribute such modifications or work under the terms of Section 1 above, provided that you also meet all of these conditions:

a) The modified work must itself be a software library.

b) You must cause the files modified to carry prominent notices stating that you changed the files and the date of any change.

c) You must cause the whole of the work to be licensed at no charge to all third parties under the terms of this License.

- d)** If a facility in the modified Library refers to a function or a table of data to be supplied by an application program that uses the facility, other than as an argument passed when the facility is invoked, then you must make a good faith effort to ensure that, in the event an application does not supply such function or table, the facility still operates, and performs whatever part of its purpose remains meaningful.

(For example, a function in a library to compute square roots has a purpose that is entirely well-defined independent of the application. Therefore, Subsection 2d requires that any application-supplied function or table used by this function must be optional: if the application does not supply it, the square root function must still compute square roots.)

These requirements apply to the modified work as a whole. If identifiable sections of that work are not derived from the Library, and can be reasonably considered independent and separate works in themselves, then this License, and its terms, do not apply to those sections when you distribute them as separate works. But when you distribute the same sections as part of a whole which is a work based on the Library, the distribution of the whole must be on the terms of this License, whose permissions for other licensees extend to the entire whole, and thus to each and every part regardless of who wrote it.

Thus, it is not the intent of this section to claim rights or contest your rights to work written entirely by you; rather, the intent is to exercise the right to control the distribution of derivative or collective works based on the Library.

In addition, mere aggregation of another work not based on the Library with the Library (or with a work based on the Library) on a volume of a storage or distribution medium does not bring the other work under the scope of this License.

- 3.** You may opt to apply the terms of the ordinary GNU General Public License instead of this License to a given copy of the Library. To do this, you must alter all the notices that refer to this License, so that they refer to the ordinary GNU General Public License, version 2, instead of to this License. (If a newer version than version 2 of the ordinary GNU General Public License has appeared, then you can specify that version instead if you wish.) Do not make any other change in these notices.

Once this change is made in a given copy, it is irreversible for that copy, so the ordinary GNU General Public License applies to all subsequent copies and derivative works made from that copy.

This option is useful when you wish to copy part of the code of the Library into a program that is not a library.

- 4.** You may copy and distribute the Library (or a portion or derivative of it, under Section 2) in object code or executable form under the terms of Sections 1 and 2 above provided that you accompany it with the complete corresponding machine-readable source code, which must be distributed under the terms of Sections 1 and 2 above on a medium customarily used for software interchange.

If distribution of object code is made by offering access to copy from a designated place, then offering equivalent access to copy the source code from the same place satisfies the requirement to distribute the source code, even though third parties are not compelled to copy the source code along with the object code.

- 5.** A program that contains no derivative of any portion of the Library, but is designed to work with the Library by being compiled or linked with it, is called a "work that uses the Library". Such a work, in isolation, is not a derivative work of the Library, and therefore falls outside the scope of this License.

However, linking a "work that uses the Library" with the Library creates an executable that is a derivative of the Library (because it contains portions of the Library), rather than a "work that uses the library". The executable is therefore covered by this License. Section 6 states terms for distribution of such executables.

When a "work that uses the Library" uses material from a header file that is part of the Library, the object code for the work may be a derivative work of the Library even though the source code is not. Whether this is true is especially significant if the work can be linked without the Library, or if the work is itself a library. The threshold for this to be true is not precisely defined by law.

If such an object file uses only numerical parameters, data structure layouts and accessors, and small macros and small inline functions (ten lines or less in length), then the use of the object file is unrestricted, regardless of whether it is legally a derivative work. (Executables containing this object code plus portions of the Library will still fall under Section 6.)

Otherwise, if the work is a derivative of the Library, you may distribute the object code for the work under the terms of Section 6. Any executables containing that work also fall under Section 6, whether or not they are linked directly with the Library itself.

- 6.** As an exception to the Sections above, you may also combine or link a "work that uses the Library" with the Library to produce a work containing portions of the Library, and distribute that work under terms of your choice, provided that the terms permit modification of the work for the customer's own use and reverse engineering for debugging such modifications.

You must give prominent notice with each copy of the work that the Library is used in it and that the Library and its use are covered by this License. You must supply a copy of this License. If the work during execution displays copyright notices, you must include the copyright notice for the Library among them, as well as a reference directing the user to the copy of this License. Also, you must do one of these things:

- a)** Accompany the work with the complete corresponding machine-readable source code for the Library including whatever changes were used in the work (which must be distributed under Sections 1 and 2 above); and, if the work is an executable linked with the Library, with the complete machine-readable "work that uses the Library", as object code and/or source code, so that the user can modify the Library and then relink to produce a modified executable containing the modified Library. (It is understood that the user who changes the contents of definitions files in the Library will not necessarily be able to recompile the application to use the modified definitions.)
- b)** Use a suitable shared library mechanism for linking with the Library. A suitable mechanism is one that (1) uses at run time a copy of the library already present on the user's computer system, rather than copying library functions into the executable, and (2) will operate properly with a modified version of the library, if the user installs one, as long as the modified version is interface-compatible with the version that the work was made with.
- c)** Accompany the work with a written offer, valid for at least three years, to give the same user the materials specified in Subsection 6a, above, for a charge no more than the cost of performing this distribution.
- d)** If distribution of the work is made by offering access to copy from a designated place, offer equivalent access to copy the above specified materials from the same place.
- e)** Verify that the user has already received a copy of these materials or that you have already sent this user a copy.

For an executable, the required form of the "work that uses the Library" must include any data and utility programs needed for reproducing the executable from it. However, as a special exception, the materials to be distributed need not include anything that is normally distributed (in either source or binary form) with the major components (compiler, kernel, and so on) of the operating system on which the executable runs, unless that component itself accompanies the executable.

It may happen that this requirement contradicts the license restrictions of other proprietary libraries that do not normally accompany the operating system. Such a contradiction means you cannot use both them and the Library together in an executable that you distribute.

- 7.** You may place library facilities that are a work based on the Library side-by-side in a single library together with other library facilities not covered by this License, and distribute such a combined library, provided that the separate distribution of the work based on the Library and of the other library facilities is otherwise permitted, and provided that you do these two things:

- a)** Accompany the combined library with a copy of the same work based on the Library, uncombined with any other library facilities. This must be distributed under the terms of the Sections above.
- b)** Give prominent notice with the combined library of the fact that part of it is a work based on the Library, and explaining where to find the accompanying uncombined form of the same work.

- 8.** You may not copy, modify, sublicense, link with, or distribute the Library except as expressly provided under this License. Any attempt otherwise to copy, modify, sublicense, link with, or distribute the Library is void, and will automatically terminate your rights under this License. However, parties who have received copies, or rights, from you under this License will not have their licenses terminated so long as such parties remain in full compliance.

- 9.** You are not required to accept this License, since you have not signed it. However, nothing else grants you permission to modify or distribute the Library or its derivative works. These actions are prohibited by law if you do not accept this License. Therefore, by modifying or distributing the Library (or any work based on the Library), you indicate your acceptance of this License to do so, and all its terms and conditions for copying, distributing or modifying the Library or works based on it.

- 10.** Each time you redistribute the Library (or any work based on the Library), the recipient automatically receives a license from the original licensor to copy, distribute, link with or modify the Library subject to these terms and conditions. You may not impose any further restrictions on the recipients' exercise of the rights granted herein. You are not responsible for enforcing compliance by third parties with this License.

11. If, as a consequence of a court judgment or allegation of patent infringement or for any other reason (not limited to patent issues), conditions are imposed on you (whether by court order, agreement or otherwise) that contradict the conditions of this License, they do not excuse you from the conditions of this License. If you cannot distribute so as to satisfy simultaneously your obligations under this License and any other pertinent obligations, then as a consequence you may not distribute the Library at all. For example, if a patent license would not permit royalty-free redistribution of the Library by all those who receive copies directly or indirectly through you, then the only way you could satisfy both it and this License would be to refrain entirely from distribution of the Library.

If any portion of this section is held invalid or unenforceable under any particular circumstance, the balance of the section is intended to apply, and the section as a whole is intended to apply in other circumstances.

It is not the purpose of this section to induce you to infringe any patents or other property right claims or to contest validity of any such claims; this section has the sole purpose of protecting the integrity of the free software distribution system which is implemented by public license practices. Many people have made generous contributions to the wide range of software distributed through that system in reliance on consistent application of that system; it is up to the author/donor to decide if he or she is willing to distribute software through any other system and a licensee cannot impose that choice.

This section is intended to make thoroughly clear what is believed to be a consequence of the rest of this License.

12. If the distribution and/or use of the Library is restricted in certain countries either by patents or by copyrighted interfaces, the original copyright holder who places the Library under this License may add an explicit geographical distribution limitation excluding those countries, so that distribution is permitted only in or among countries not thus excluded. In such case, this License incorporates the limitation as if written in the body of this License.
13. The Free Software Foundation may publish revised and/or new versions of the Lesser General Public License from time to time. Such new versions will be similar in spirit to the present version, but may differ in detail to address new problems or concerns.

Each version is given a distinguishing version number. If the Library specifies a version number of this License which applies to it and "any later version", you have the option of following the terms and conditions either of that version or of any later version published by the Free Software Foundation. If the Library does not specify a license version number, you may choose any version ever published by the Free Software Foundation.

14. If you wish to incorporate parts of the Library into other free programs whose distribution conditions are incompatible with these, write to the author to ask for permission. For software which is copyrighted by the Free Software Foundation, write to the Free Software Foundation; we sometimes make exceptions for this. Our decision will be guided by the two goals of preserving the free status of all derivatives of our free software and of promoting the sharing and reuse of software generally.

NO WARRANTY

15. BECAUSE THE LIBRARY IS LICENSED FREE OF CHARGE, THERE IS NO WARRANTY FOR THE LIBRARY, TO THE EXTENT PERMITTED BY APPLICABLE LAW. EXCEPT WHEN OTHERWISE STATED IN WRITING THE COPYRIGHT HOLDERS AND/OR OTHER PARTIES PROVIDE THE LIBRARY "AS IS" WITHOUT WARRANTY OF ANY KIND, EITHER EXPRESSED OR IMPLIED, INCLUDING, BUT NOT LIMITED TO, THE IMPLIED WARRANTIES OF MERCHANTABILITY AND FITNESS FOR A PARTICULAR PURPOSE. THE ENTIRE RISK AS TO THE QUALITY AND PERFORMANCE OF THE LIBRARY IS WITH YOU. SHOULD THE LIBRARY PROVE DEFECTIVE, YOU ASSUME THE COST OF ALL NECESSARY SERVICING, REPAIR OR CORRECTION.
16. IN NO EVENT UNLESS REQUIRED BY APPLICABLE LAW OR AGREED TO IN WRITING WILL ANY COPYRIGHT HOLDER, OR ANY OTHER PARTY WHO MAY MODIFY AND/OR REDISTRIBUTE THE LIBRARY AS PERMITTED ABOVE, BE LIABLE TO YOU FOR DAMAGES, INCLUDING ANY GENERAL, SPECIAL, INCIDENTAL OR CONSEQUENTIAL DAMAGES ARISING OUT OF THE USE OR INABILITY TO USE THE LIBRARY (INCLUDING BUT NOT LIMITED TO LOSS OF DATA OR DATA BEING RENDERED INACCURATE OR LOSSES SUSTAINED BY YOU OR THIRD PARTIES OR A FAILURE OF THE LIBRARY TO OPERATE WITH ANY OTHER SOFTWARE), EVEN IF SUCH HOLDER OR OTHER PARTY HAS BEEN ADVISED OF THE POSSIBILITY OF SUCH DAMAGES.

END OF TERMS AND CONDITIONS

How to Apply These Terms to Your New Libraries

If you develop a new library, and you want it to be of the greatest possible use to the public, we recommend making it free software that everyone can redistribute and change. You can do so by permitting redistribution under these terms (or, alternatively, under the terms of the ordinary General Public License).

To apply these terms, attach the following notices to the library. It is safest to attach them to the start of each source file to most effectively convey the exclusion of warranty; and each file should have at least the "copyright" line and a pointer to where the full notice is found.

<one line to give the library's name and a brief idea of what it does.>
Copyright © <year> <name of author>

This library is free software; you can redistribute it and/or modify it under the terms of the GNU Lesser General Public License as published by the Free Software Foundation; either version 2.1 of the License, or (at your option) any later version.

This library is distributed in the hope that it will be useful, but WITHOUT ANY WARRANTY; without even the implied warranty of MERCHANTABILITY or FITNESS FOR A PARTICULAR PURPOSE. See the GNU Lesser General Public License for more details.

You should have received a copy of the GNU Lesser General Public License along with this library; if not, write to the Free Software Foundation, Inc., 51 Franklin Street, Fifth Floor, Boston, MA 02110-1301 USA

Also add information on how to contact you by electronic and paper mail.

You should also get your employer (if you work as a programmer) or your school, if any, to sign a "copyright disclaimer" for the library, if necessary. Here is a sample; alter the names:

Yoyodyne, Inc., hereby disclaims all copyright interest in the library 'Frob' (a library for tweaking knobs) written by James Random Hacker.

<signature of Ty Coon>, 1 April 1990
Ty Coon, President of Vice

That's all there is to it!

Note on source code distribution

For three years after the final factory shipment, you may request from Yamaha the source code for any portions of the product which are licensed under the GNU General Public License or GNU Lesser General Public License by writing to one of the Yamaha office addresses listed at the end of this Owner's Manual.

The source code will be provided at no charge; however, we may require you to reimburse Yamaha for the cost of delivering the source code to you.

- Note that we shall bear no responsibility whatsoever for any damage arising from changes (additions/ deletions) made to the software for this product by a third party other than Yamaha (or party authorized by Yamaha).
- Note that re-use of source code released to the public domain by Yamaha is unguaranteed, and Yamaha shall not bear any responsibility whatsoever for the source code.
- The source code can be downloaded from the following address:
<https://download.yamaha.com/sourcecodes/ekb/>

libpng

This copy of the libpng notices is provided for your convenience. In case of any discrepancy between this copy and the notices in the file png.h that is included in the libpng distribution, the latter shall prevail.

COPYRIGHT NOTICE, DISCLAIMER, and LICENSE:

If you modify libpng you may insert additional notices immediately following this sentence.

This code is released under the libpng license.

libpng versions 1.0.7, July 1, 2000 through 1.6.28, January 5, 2017 are Copyright (c) 2000-2002, 2004, 2006-2017 Glenn Randers-Pehrson, are derived from libpng-1.0.6, and are distributed according to the same disclaimer and license as libpng-1.0.6 with the following individuals added to the list of Contributing Authors:

Simon-Pierre Cadieux
Eric S. Raymond
Mans Rullgard
Cosmin Truta
Gilles Vollant
James Yu
Mandar Sahastrabudhe

and with the following additions to the disclaimer:

There is no warranty against interference with your enjoyment of the library or against infringement. There is no warranty that our efforts or the library will fulfill any of your particular purposes or needs. This library is provided with all faults, and the entire risk of satisfactory quality, performance, accuracy, and effort is with the user.

Some files in the "contrib" directory and some configure-generated files that are distributed with libpng have other copyright owners and are released under other open source licenses.

libpng versions 0.97, January 1998, through 1.0.6, March 20, 2000, are Copyright (c) 1998-2000 Glenn Randers-Pehrson, are derived from libpng-0.96, and are distributed according to the same disclaimer and license as libpng-0.96, with the following individuals added to the list of Contributing Authors:

Tom Lane
Glenn Randers-Pehrson
Willem van Schaik

libpng versions 0.89, June 1996, through 0.96, May 1997, are Copyright (c) 1996-1997 Andreas Dilger, are derived from libpng-0.88, and are distributed according to the same disclaimer and license as libpng-0.88, with the following individuals added to the list of Contributing Authors:

John Bowler
Kevin Bracey
Sam Bushell
Magnus Holmgren
Greg Roelofs
Tom Tanner

Some files in the "scripts" directory have other copyright owners but are released under this license.

libpng versions 0.5, May 1995, through 0.88, January 1996, are Copyright (c) 1995-1996 Guy Eric Schalnat, Group 42, Inc.

For the purposes of this copyright and license, "Contributing Authors" is defined as the following set of individuals:

Andreas Dilger
Dave Martindale
Guy Eric Schalnat
Paul Schmidt
Tim Wegner

The PNG Reference Library is supplied "AS IS". The Contributing Authors and Group 42, Inc. disclaim all warranties, expressed or implied, including, without limitation, the warranties of merchantability and of fitness for any purpose. The Contributing Authors and Group 42, Inc. assume no liability for direct, indirect, incidental, special, exemplary, or consequential damages, which may result from the use of the PNG Reference Library, even if advised of the possibility of such damage.

Permission is hereby granted to use, copy, modify, and distribute this source code, or portions hereof, for any purpose, without fee, subject to the following restrictions:

1. The origin of this source code must not be misrepresented.
2. Altered versions must be plainly marked as such and must not be misrepresented as being the original source.
3. This Copyright notice may not be removed or altered from any source or altered source distribution.

The Contributing Authors and Group 42, Inc. specifically permit, without fee, and encourage the use of this source code as a component to supporting the PNG file format in commercial products. If you use this source code in a product, acknowledgment is not required but would be appreciated.

END OF COPYRIGHT NOTICE, DISCLAIMER, and LICENSE.

TRADEMARK:

The name "libpng" has not been registered by the Copyright owner as a trademark in any jurisdiction. However, because libpng has been distributed and maintained world-wide, continually since 1995, the Copyright owner claims "common-law trademark protection" in any jurisdiction where common-law trademark is recognized.

OSI CERTIFICATION:

Libpng is OSI Certified Open Source Software. OSI Certified Open Source is a certification mark of the Open Source Initiative. OSI has not addressed the additional disclaimers inserted at version 1.0.7.

EXPORT CONTROL:

The Copyright owner believes that the Export Control Classification Number (ECCN) for libpng is EAR99, which means not subject to export controls or International Traffic in Arms Regulations (ITAR) because it is open source, publicly available software, that does not contain any encryption software. See the EAR, paragraphs 734.3(b)(3) and 734.7(b).

Glenn Randers-Pehrson
glennrp at users.sourceforge.net
January 5, 2017

libuuid

Copyright: 1996, 1997, 1998, 1999, 2007 Theodore Ts'o.
1999 Andreas Dilger (adilger@enl.ualgary.ca)

Redistribution and use in source and binary forms, with or without modification, are permitted provided that the following conditions are met:

1. Redistributions of source code must retain the above copyright notice, and the entire permission notice in its entirety, including the disclaimer of warranties.
2. Redistributions in binary form must reproduce the above copyright notice, this list of conditions and the following disclaimer in the documentation and/or other materials provided with the distribution.
3. The name of the author may not be used to endorse or promote products derived from this software without specific prior written permission.

THIS SOFTWARE IS PROVIDED "AS IS" AND ANY EXPRESS OR IMPLIED WARRANTIES, INCLUDING, BUT NOT LIMITED TO, THE IMPLIED WARRANTIES OF MERCHANTABILITY AND FITNESS FOR A PARTICULAR PURPOSE, ALL OF WHICH ARE HEREBY DISCLAIMED. IN NO EVENT SHALL THE AUTHOR BE LIABLE FOR ANY DIRECT, INDIRECT, INCIDENTAL, SPECIAL, EXEMPLARY, OR CONSEQUENTIAL DAMAGES (INCLUDING, BUT NOT LIMITED TO, PROCUREMENT OF SUBSTITUTE GOODS OR SERVICES; LOSS OF USE, DATA, OR PROFITS; OR BUSINESS INTERRUPTION) HOWEVER CAUSED AND ON ANY THEORY OF LIABILITY, WHETHER IN CONTRACT, STRICT LIABILITY, OR TORT (INCLUDING NEGLIGENCE OR OTHERWISE) ARISING IN ANY WAY OUT OF THE USE OF THIS SOFTWARE, EVEN IF NOT ADVISED OF THE POSSIBILITY OF SUCH DAMAGE.

libjpeg

This software is based in part on the work of the Independent JPEG Group.

imagemagick

Licensed under the ImageMagick License (the "License"); you may not use this file except in compliance with the License. You may obtain a copy of the License at

<https://www.imagemagick.org/script/license.php>

Unless required by applicable law or agreed to in writing, software distributed under the License is distributed on an "AS IS" BASIS, WITHOUT WARRANTIES OR CONDITIONS OF ANY KIND, either express or implied. See the License for the specific language governing permissions and limitations under the License.

FreeType

Portions of this software are copyright © 2016 The FreeType Project (www.freetype.org). All rights reserved.

ICU

COPYRIGHT AND PERMISSION NOTICE

Copyright © 1991-2016 Unicode, Inc. All rights reserved.
Distributed under the Terms of Use in <http://www.unicode.org/copyright.html>.

Permission is hereby granted, free of charge, to any person obtaining a copy of the Unicode data files and any associated documentation (the "Data Files") or Unicode software and any associated documentation (the "Software") to deal in the Data Files or Software without restriction, including without limitation the rights to use, copy, modify, merge, publish, distribute, and/or sell copies of the Data Files or Software, and to permit persons to whom the Data Files or Software are furnished to do so, provided that either (a) this copyright and permission notice appear with all copies of the Data Files or Software, or (b) this copyright and permission notice appear in associated Documentation.

THE DATA FILES AND SOFTWARE ARE PROVIDED "AS IS"; WITHOUT WARRANTY OF ANY KIND, EXPRESS OR IMPLIED, INCLUDING BUT NOT LIMITED TO THE WARRANTIES OF MERCHANTABILITY, FITNESS FOR A PARTICULAR PURPOSE AND NONINFRINGEMENT OF THIRD PARTY RIGHTS.

IN NO EVENT SHALL THE COPYRIGHT HOLDER OR HOLDERS INCLUDED IN THIS NOTICE BE LIABLE FOR ANY CLAIM, OR ANY SPECIAL INDIRECT OR CONSEQUENTIAL DAMAGES, OR ANY DAMAGES WHATSOEVER RESULTING FROM LOSS OF USE, DATA OR PROFITS, WHETHER IN AN ACTION OF CONTRACT, NEGLIGENCE OR OTHER TORTIOUS ACTION, ARISING OUT OF OR IN CONNECTION WITH THE USE OR PERFORMANCE OF THE DATA FILES OR SOFTWARE.

Except as contained in this notice, the name of a copyright holder shall not be used in advertising or otherwise to promote the sale, use or other dealings in these Data Files or Software without prior written authorization of the copyright holder.

jemalloc

Copyright (C) 2002-2014 Jason Evans <jasone@canonware.com>. All rights reserved.

Copyright (C) 2007-2012 Mozilla Foundation. All rights reserved.
Copyright (C) 2009-2014 Facebook, Inc. All rights reserved.

Redistribution and use in source and binary forms, with or without modification, are permitted provided that the following conditions are met:

1. Redistributions of source code must retain the above copyright notice(s), this list of conditions and the following disclaimer.
2. Redistributions in binary form must reproduce the above copyright notice(s), this list of conditions and the following disclaimer in the documentation and/or other materials provided with the distribution.

THIS SOFTWARE IS PROVIDED BY THE COPYRIGHT HOLDER(S) "AS IS" AND ANY EXPRESS OR IMPLIED WARRANTIES, INCLUDING, BUT NOT LIMITED TO, THE IMPLIED WARRANTIES OF MERCHANTABILITY AND FITNESS FOR A PARTICULAR PURPOSE ARE DISCLAIMED. IN NO EVENT SHALL THE COPYRIGHT HOLDER(S) BE LIABLE FOR ANY DIRECT, INDIRECT, INCIDENTAL, SPECIAL, EXEMPLARY, OR CONSEQUENTIAL DAMAGES (INCLUDING, BUT NOT LIMITED TO, PROCUREMENT OF SUBSTITUTE GOODS OR SERVICES; LOSS OF USE, DATA, OR PROFITS; OR BUSINESS INTERRUPTION) HOWEVER CAUSED AND ON ANY THEORY OF LIABILITY, WHETHER IN CONTRACT, STRICT LIABILITY, OR TORT (INCLUDING NEGLIGENCE OR OTHERWISE) ARISING IN ANY WAY OUT OF THE USE OF THIS SOFTWARE, EVEN IF ADVISED OF THE POSSIBILITY OF SUCH DAMAGE.

libss2 / libcomerr2

Copyright 1987, 1988 by the Student Information Processing Board of the Massachusetts Institute of Technology

Permission to use, copy, modify, and distribute this software and its documentation for any purpose and without fee is hereby granted, provided that the above copyright notice appear in all copies and that both that copyright notice and this permission notice appear in supporting documentation, and that the names of M.I.T. and the M.I.T. S.I.P.B. not be used in advertising or publicity pertaining to distribution of the software without specific, written prior permission.

M.I.T. and the M.I.T. S.I.P.B. make no representations about the suitability of this software for any purpose. It is provided "as is" without express or implied warranty.

libpopt0

Copyright (c) 1998 Red Hat Software

Permission is hereby granted, free of charge, to any person obtaining a copy of this software and associated documentation files (the "Software"), to deal in the Software without restriction, including without limitation the rights to use, copy, modify, merge, publish, distribute, sublicense, and/or sell copies of the Software, and to permit persons to whom the Software is furnished to do so, subject to the following conditions:

The above copyright notice and this permission notice shall be included in all copies or substantial portions of the Software.

THE SOFTWARE IS PROVIDED "AS IS"; WITHOUT WARRANTY OF ANY KIND, EXPRESS OR IMPLIED, INCLUDING BUT NOT LIMITED TO THE WARRANTIES OF MERCHANTABILITY, FITNESS FOR A PARTICULAR PURPOSE AND NONINFRINGEMENT. IN NO EVENT SHALL THE X CONSORTIUM BE LIABLE FOR ANY CLAIM, DAMAGES OR OTHER LIABILITY, WHETHER IN AN ACTION OF CONTRACT, TORT OR OTHERWISE, ARISING FROM, OUT OF OR IN CONNECTION WITH THE SOFTWARE OR THE USE OR OTHER DEALINGS IN THE SOFTWARE.

Except as contained in this notice, the name of the X Consortium shall not be used in advertising or otherwise to promote the sale, use or other dealings in this Software without prior written authorization from the X Consortium.

pcre

PCRE LICENCE

PCRE is a library of functions to support regular expressions whose syntax and semantics are as close as possible to those of the Perl 5 language.

Release 8 of PCRE is distributed under the terms of the "BSD" licence, as specified below. The documentation for PCRE, supplied in the "doc" directory, is distributed under the same terms as the software itself.

The basic library functions are written in C and are freestanding. Also included in the distribution is a set of C++ wrapper functions, and a just-in-time compiler that can be used to optimize pattern matching. These are both optional features that can be omitted when the library is built.

THE BASIC LIBRARY FUNCTIONS

Written by: Philip Hazel
Email local part: ph10
Email domain: cam.ac.uk

University of Cambridge Computing Service,
Cambridge, England.

Copyright (c) 1997-2012 University of Cambridge
All rights reserved.

PCRE JUST-IN-TIME COMPILATION SUPPORT

Written by: Zoltan Herczeg
Email local part: hzmester
Email domain: freemail.hu

Copyright(c) 2010-2012 Zoltan Herczeg
All rights reserved.

STACK-LESS JUST-IN-TIME COMPILER

Written by: Zoltan Herczeg
Email local part: hzmester
Email domain: freemail.hu

Copyright(c) 2009-2012 Zoltan Herczeg
All rights reserved.

THE C++ WRAPPER FUNCTIONS

Contributed by: Google Inc.

Copyright (c) 2007-2012, Google Inc.
All rights reserved.

THE "BSD" LICENSE

Redistribution and use in source and binary forms, with or without modification, are permitted provided that the following conditions are met:

- * Redistributions of source code must retain the above copyright notice, this list of conditions and the following disclaimer.
- * Redistributions in binary form must reproduce the above copyright notice, this list of conditions and the following disclaimer in the documentation and/or other materials provided with the distribution.
- * Neither the name of the University of Cambridge nor the name of Google Inc. nor the names of their contributors may be used to endorse or promote products derived from this software without specific prior written permission.

THIS SOFTWARE IS PROVIDED BY THE COPYRIGHT HOLDERS AND CONTRIBUTORS "AS IS" AND ANY EXPRESS OR IMPLIED WARRANTIES, INCLUDING, BUT NOT LIMITED TO, THE IMPLIED WARRANTIES OF MERCHANTABILITY AND FITNESS FOR A PARTICULAR PURPOSE ARE DISCLAIMED. IN NO EVENT SHALL THE COPYRIGHT OWNER OR CONTRIBUTORS BE LIABLE FOR ANY DIRECT, INDIRECT, INCIDENTAL, SPECIAL, EXEMPLARY, OR CONSEQUENTIAL DAMAGES (INCLUDING, BUT NOT LIMITED TO, PROCUREMENT OF SUBSTITUTE GOODS OR SERVICES; LOSS OF USE, DATA, OR PROFITS; OR BUSINESS INTERRUPTION) HOWEVER CAUSED AND ON ANY THEORY OF LIABILITY, WHETHER IN CONTRACT, STRICT LIABILITY, OR TORT (INCLUDING NEGLIGENCE OR OTHERWISE) ARISING IN ANY WAY OUT OF THE USE OF THIS SOFTWARE, EVEN IF ADVISED OF THE POSSIBILITY OF SUCH DAMAGE.

End

Apache License2.0

Copyright (c) 2009-2018 Arm Limited. All rights reserved.

SPDX-License-Identifier: Apache-2.0

Licensed under the Apache License, Version 2.0 (the License); you may not use this file except in compliance with the License. You may obtain a copy of the License at

www.apache.org/licenses/LICENSE-2.0

Unless required by applicable law or agreed to in writing, software distributed under the License is distributed on an AS IS BASIS, WITHOUT WARRANTIES OR CONDITIONS OF ANY KIND, either express or implied. See the License for the specific language governing permissions and limitations under the License.

The Clear BSD license

The Clear BSD License
Copyright 1997-2016 Freescale Semiconductor, Inc.
Copyright 2016-2018 NXP
All rights reserved.

Redistribution and use in source and binary forms, with or without modification, are permitted (subject to the limitations in the disclaimer below) provided that the following conditions are met:

Redistributions of source code must retain the above copyright notice, this list of conditions and the following disclaimer.

Redistributions in binary form must reproduce the above copyright notice, this list of conditions and the following disclaimer in the documentation and/or other materials provided with the distribution.

Neither the name of the copyright holder nor the names of its contributors may be used to endorse or promote products derived from this software without specific prior written permission.

NO EXPRESS OR IMPLIED LICENSES TO ANY PARTY'S PATENT RIGHTS ARE GRANTED BY THIS LICENSE. THIS SOFTWARE IS PROVIDED BY THE COPYRIGHT HOLDERS AND CONTRIBUTORS "AS IS" AND ANY EXPRESS OR IMPLIED WARRANTIES, INCLUDING, BUT NOT LIMITED TO, THE IMPLIED WARRANTIES OF MERCHANTABILITY AND FITNESS FOR A PARTICULAR PURPOSE ARE DISCLAIMED. IN NO EVENT SHALL THE COPYRIGHT HOLDER OR CONTRIBUTORS BE LIABLE FOR ANY DIRECT, INDIRECT, INCIDENTAL, SPECIAL, EXEMPLARY, OR CONSEQUENTIAL DAMAGES (INCLUDING, BUT NOT LIMITED TO, PROCUREMENT OF SUBSTITUTE GOODS OR SERVICES;

LOSS OF USE, DATA, OR PROFITS; OR BUSINESS INTERRUPTION) HOWEVER CAUSED AND ON ANY THEORY OF LIABILITY, WHETHER IN CONTRACT, STRICT LIABILITY, OR TORT (INCLUDING NEGLIGENCE OR OTHERWISE) ARISING IN ANY WAY OUT OF THE USE OF THIS SOFTWARE, EVEN IF ADVISED OF THE POSSIBILITY OF SUCH DAMAGE.

Important Notice: Guarantee Information for customers in European Economic Area (EEA) and Switzerland

Important Notice: Guarantee Information for customers in EEA* and Switzerland For detailed guarantee information about this Yamaha product, and Pan-EEA* and Switzerland warranty service, please either visit the website address below (Printable file is available at our website) or contact the Yamaha representative office for your country. * EEA: European Economic Area	English
Wichtiger Hinweis: Garantie-Information für Kunden in der EWR* und der Schweiz Für nähere Garantie-Information über dieses Produkt von Yamaha, sowie über den Pan-EWR*- und Schweizer Garantieservice, besuchen Sie bitte entweder die folgend angegebene Internetadresse (eine druckfähige Version befindet sich auch auf unserer Webseite), oder wenden Sie sich an den für Ihr Land zuständigen Yamaha-Vertrieb. * EWR: Europäischer Wirtschaftsraum	Deutsch
Remarque importante: informations de garantie pour les clients de l'EEE et la Suisse Pour des informations plus détaillées sur la garantie de ce produit Yamaha et sur le service de garantie applicable dans l'ensemble de l'EEE ainsi qu'en Suisse, consultez notre site Web à l'adresse ci-dessous (le fichier imprimable est disponible sur notre site Web) ou contactez directement Yamaha dans votre pays de résidence. * EEE : Espace Economique Européen	Français
Belangrijke mededeling: Garantie-informatie voor klanten in de EER* en Zwitserland Voor gedetailleerde garantie-informatie over dit Yamaha-product en de garantieservice in heel de EER* en Zwitserland, gaat u naar de onderstaande website (u vindt een afdrukbaar bestand op onze website) of neemt u contact op met de vertegenwoordiging van Yamaha in uw land. * EER: Europese Economische Ruimte	Nederlands
Aviso importante: información sobre la garantía para los clientes del EEE* y Suiza Para una información detallada sobre este producto Yamaha y sobre el soporte de garantía en la zona EEE* y Suiza, visite la dirección web que se incluye más abajo (la versión del archivo para imprimir esta disponible en nuestro sitio web) o póngase en contacto con el representante de Yamaha en su país. * EEE: Espacio Económico Europeo	Español
Avviso importante: informazioni sulla garanzia per i clienti residenti nell'EEA* e in Svizzera Per informazioni dettagliate sulla garanzia relativa a questo prodotto Yamaha e l'assistenza in garanzia nei paesi EEA* e in Svizzera, potete consultare il sito Web all'indirizzo riportato di seguito (è disponibile il file in formato stampabile) oppure contattare l'ufficio di rappresentanza locale della Yamaha. * EEA: Area Economica Europea	Italiano
Aviso importante: informações sobre as garantias para clientes da AEE* e da Suíça Para obter uma informação pormenorizada sobre este produto da Yamaha e sobre o serviço de garantia na AEE* e na Suíça, visite o site a seguir (o arquivo para impressão está disponível no nosso site) ou entre em contato com o escritório de representação da Yamaha no seu país. * AEE: Área Económica Europeia	Português
Σημαντική σημείωση: Πληροφορίες εγγύησης για τους πελάτες στον ΕΟΧ* και Ελλάδα Για λεπτομερείς πληροφορίες εγγύησης σχετικά με το παρόν προϊόν της Yamaha και την κάλυψη εγγύησης σε όλες τις χώρες του ΕΟΧ και την Ελλάδα, επισκεφτείτε την παρακάτω ιστοσελίδα (Εκτυπώσιμη μορφή είναι διαθέσιμη στην ιστοσελίδα μας) ή απευθυνθείτε στην αντιπροσωπεία της Yamaha στη χώρα σας. * ΕΟΧ: Ευρωπαϊκός Οικονομικός Χώρος	Ελληνικά
Viktigt: Garantiinformasjon for kunder i EES-området* och Schweiz För detaljerad information om denna Yamahaprodukt samt garantiservice i hela EES-området* och Schweiz kan du antingen besöka nedanstående webbadress (en utskriftsvänlig fil finns på webbplatsen) eller kontakta Yamahas officiella representant i ditt land. * EES: Europeiska Ekonomiska Samarbetsområdet	Svenska
Viktig merknad: Garantiinformasjon for kunder i EØS* og Sveits Detaljert garantiinformasjon om dette Yamaha-produktet og garantiservice for hele EØS-området* og Sveits kan fås enten ved å besøke nettstedene nedenfor (utskriftsversjon finnes på våre nettsider) eller kontakte Yamahas kontoret i landet der du bor. *EØS: Det europeiske økonomiske samarbeidsområdet	Norsk
Vigtig oplysning: Garantioplysninger til kunder i EØ* og Schweiz De kan finde detaljerede garantioplysninger om dette Yamaha-produkt og den fælles garantiserviceordning for EØ* (og Schweiz) ved at besøge det websted, der er angivet nedenfor (der findes en fil, som kan udskrives, på vores websted), eller ved at kontakte Yamahas nationale repræsentationskontor i det land, hvor De bor. * EØ: Det Europæiske Økonomiske Område	Dansk
Tärkeä ilmoitus: Takuutiedot Euroopan talousalueen (ETA)* ja Sveitsin asiakkaille Tämän Yamaha-tuotteen sekä ETA-alueen ja Sveitsin takuuta koskevat yksityiskohtaiset tiedot saatte alla olevasta nettiosoitteesta. (Tulostettava tiedosto saatavissa sivustollamme.) Voitite myös ottaa yhteyttä paikalliseen Yamaha-edustajaan. *ETA: Euroopan talousalue	Suomi
Ważne: Warunki gwarancyjne obowiązujące w EOG* i Szwajcarii Aby dowiedzieć się więcej na temat warunków gwarancyjnych tego produktu firmy Yamaha i serwisu gwarancyjnego w całym EOG* i Szwajcarii, należy odwiedzić wskazaną poniżej stronę internetową (Plik gotowy do wydruku znajduje się na naszej stronie internetowej) lub skontaktować się z przedstawicielstwem firmy Yamaha w swoim kraju. * EOG — Europejski Obszar Gospodarczy	Polski
Dôležité oznámení: Záruční informácie pro zákazníky v EHS* a ve Švýcarsku Podrobné záruční informácie o tomto produkte Yamaha a záručním servisu v celém EHS* a ve Švýcarsku naleznete na níže uvedené webové adrese (soubor k tisku je dostupný na našich webových stránkách) nebo se můžete obrátit na zastoupení firmy Yamaha ve své zemi. * EHS: Evropský hospodářský prostor	Česky
Fontos figyelemzetés: Garancia-információk az EGT* területén és Svájcban élő vásárlók számára A jelen Yamaha termékre vonatkozó részletes garancia-információk, valamint az EGT*-re és Svájcra kiterjedő garanciális szolgáltatás tekintetében keresse fel webhelyünket az alábbi címen (a webhelyen nyomtatható fájl is talál), vagy pedig lépjen kapcsolatba az országában működő Yamaha képviselői irodával. * EGT: Európai Gazdasági Térség	Magyar
Oluline märkus: Garantiteave Euroopa Majanduspiirkonna (EMP)* ja Šveitsi klientidele Täpsemat teabe saamiseks selle Yamaha toote garantii ning kogu Euroopa Majanduspiirkonna ja Šveitsi garantiteeninduse kohta, külastage palun veebisaiti alljärgneval aadressil (meie saidil on saadaval printitav fail) või pöörduge Teie regiooni Yamaha esinduse poole. * EMP: Euroopa Majanduspiirkond	Eesti keel
Svarīgs paziņojums: garantijas informācija klientiem EEZ* un Šveicē Lai saņemtu detalizētu garantijas informāciju par šo Yamaha produktu, kā arī garantijas apkalpošanu EEZ* un Šveicē, lūdzu, apmeklējiet zemāk norādīto tīmekļa vietnes adresi (tīmekļa vietnē ir pieejams drukājams fails) vai sazinieties ar jūsu valsti apkalpojošo Yamaha pārstāvniecību. * EEZ: Eiropas Ekonomikas zona	Latviešu
Dėmesio: informacija dėl garantijos pirkėjams EEE* ir Šveicarijoje Jei reikia išsamios informacijos apie šį „Yamaha“ produktą ir jo techninę priežiūrą visoje EEE* ir Šveicarijoje, apsilankykite mūsų svetainėje toliau nurodytu adresu (svetainėje yra spausdinamas failas) arba kreipkitės į „Yamaha“ atstovybę savo šaliai. *EEE – Europos ekonominė erdvė	Lietuvių kalba
Dôležité upozornenie: Informácie o záruke pre zákazníkov v EHP* a Švajčiarsku Podrobné informácie o záruke týkajúce sa tohto produktu od spoločnosti Yamaha a garančnom servise v EHP* a Švajčiarsku nájdete na webovej stránke uvedenej nižšie (na našej webovej stránke je k dispozícii súbor na tlač) alebo sa obráťte na zástupcu spoločnosti Yamaha vo svojej krajine. * EHP: Európsky hospodársky priestor	Slovenčina
Pomembno obvestilo: Informacije o garanciji za kupce v EGP* in Švici Za podrobnejše informacije o tem Yamahinem izdelku ter garancijskem servisu v celotnem EGP in Švici, obiščite spletno mesto, ki je navedeno spodaj (natisljiva datoteka je na voljo na našem spletnem mestu), ali se obrnite na Yamahinega predstavnika v svoji državi. * EGP: Evropski gospodarski prostor	Slovenščina
Важно съобщение: Информация за гаранцията за клиенти в ЕИП* и Швейцария За подробна информация за гаранцията за този продукт на Yamaha и гаранционното обслужване в паневропейската зона на ЕИП* и Швейцария или посетете посочения по-долу уеб сайт (на нашия уеб сайт има файл за печат), или се свържете с представителния офис на Yamaha във вашата страна. * ЕИП: Европейско икономическо пространство	Български език
Notificarea importantă: Informații despre garanție pentru clienții din SEE* și Elveția Pentru informații detaliate privind acest produs Yamaha și serviciul de garanție Pan-SEE* și Elveția, vizitați site-ul la adresa de mai jos (fișierul imprimabil este disponibil pe site-ul nostru) sau contactați biroul reprezentanței Yamaha din țara dumneavoastră. * SEE: Spațiul Economic European	Limba română
Važna obavijest: Informacije o jamstvu za države EGP-a i Švicarske Za detaljne informacije o jamstvu za ovaj Yamahin proizvod te jamstvenom servisu za cijeli EGP i Švicarsku, molimo Vas da posjetite web-stranicu navedenu u nastavku ili kontaktirate ovlaštenog Yamahinog dobavljača u svojoj zemlji. * EGP: Evropski gospodarski prostor	Hrvatski

<https://europe.yamaha.com/warranty/>

URL_5



1-YEAR LIMITED WARRANTY ON ARRANGER WORKSTATION KEYBOARDS

Thank you for selecting a Yamaha product. Yamaha products are designed and manufactured to provide a high level of defect-free performance. Yamaha Corporation of America ("Yamaha") is proud of the experience and craftsmanship that goes into each and every Yamaha product. Yamaha sells its products through a network of reputable, specially authorized dealers and is pleased to offer you, the Original Owner, the following Limited Warranty, which applies only to products that have been (1) directly purchased from Yamaha's authorized dealers in the fifty states of the USA and District of Columbia (the "Warranted Area") and (2) used exclusively in the Warranted Area. Yamaha suggests that you read the Limited Warranty thoroughly, and invites you to contact your authorized Yamaha dealer or Yamaha Customer Service if you have any questions.

Coverage: Yamaha will, at its option, repair or replace the product covered by this warranty if it becomes defective, malfunctions or otherwise fails to conform with this warranty under normal use and service during the term of this warranty, without charge for labor or materials. Repairs may be performed using new or refurbished parts that meet or exceed Yamaha specifications for new parts. If Yamaha elects to replace the product, the replacement may be a reconditioned unit. You will be responsible for any installation or removal charges and for any initial shipping charges if the product(s) must be shipped for warranty service. However, Yamaha will pay the return shipping charges to any destination within the USA if the repairs are covered by the warranty. This warranty does not cover (a) damage, deterioration or malfunction resulting from accident, negligence, misuse, abuse, improper installation or operation or failure to follow instructions according to the Owner's Manual for this product; any shipment of the product (claims must be presented to the carrier); repair or attempted repair by anyone other than Yamaha or an authorized Yamaha Service Center; (b) any unit which has been altered or on which the serial number has been defaced, modified or removed; (c) normal wear and any periodic maintenance; (d) deterioration due to perspiration, corrosive atmosphere or other external causes such as extremes in temperature or humidity; (e) damages attributable to power line surge or related electrical abnormalities, lightning damage or acts of God; or (f) RFI/EMI (Interference/noise) caused by improper grounding or the improper use of either certified or uncertified equipment, if applicable. Any evidence of alteration, erasing or forgery of proof-of-purchase documents will cause this warranty to be void. This warranty covers only the Original Owner and is not transferable.

In Order to Obtain Warranty Service: Warranty service will only be provided for defective products within the Warranted Area. Contact your local authorized Yamaha dealer who will advise you of the procedures to be followed. If this is not successful, contact Yamaha at the address, telephone number or website shown below. Yamaha may request that you send the defective product to a local authorized Yamaha Servicer or authorize return of the defective product to Yamaha for repair. If you are uncertain as to whether a dealer has been authorized by Yamaha, please contact Yamaha's Service Department at the number shown below, or check Yamaha's website at www.Yamaha.com. Product(s) shipped for service should be packed securely and must be accompanied by a detailed explanation of the problem(s) requiring service, together with the original or a machine reproduction of the bill of sale or other dated, proof-of-purchase document describing the product, as evidence of warranty coverage. Should any product submitted for warranty service be found ineligible therefore, an estimate of repair cost will be furnished and the repair will be accomplished only if requested by you and upon receipt of payment or acceptable arrangement for payment.

Limitation of Implied Warranties and Exclusion of Damages: ANY IMPLIED WARRANTIES, INCLUDING WARRANTIES OF MERCHANTABILITY AND FITNESS FOR A PARTICULAR PURPOSE SHALL BE LIMITED IN DURATION TO THE APPLICABLE PERIOD OF TIME SET FORTH ABOVE. YAMAHA SHALL NOT BE RESPONSIBLE FOR INCIDENTAL OR CONSEQUENTIAL DAMAGES OR FOR DAMAGES BASED UPON INCONVENIENCE, LOSS OF USE, DAMAGE TO ANY OTHER EQUIPMENT OR OTHER ITEMS AT THE SITE OF USE OR INTERRUPTION OF PERFORMANCES OR ANY CONSEQUENCES. YAMAHA'S LIABILITY FOR ANY DEFECTIVE PRODUCT IS LIMITED TO REPAIR OR REPLACEMENT OF THE PRODUCT, AT YAMAHA'S OPTION. SOME STATES DO NOT ALLOW LIMITATIONS ON HOW LONG AN IMPLIED WARRANTY LASTS OR THE EXCLUSION OR LIMITATION OF INCIDENTAL OR CONSEQUENTIAL DAMAGES, SO THE ABOVE LIMITATION OR EXCLUSION MAY NOT APPLY TO YOU. This Warranty gives you specific legal rights, and you may also have other rights which vary from state to state. This is the only express warranty applicable to the product specified herein; Yamaha neither assumes nor authorizes anyone to assume for it any other express warranty.

If you have any questions about service received or if you need assistance in locating an authorized Yamaha Servicer, please contact:



CUSTOMER SERVICE
Yamaha Corporation of America
6600 Orangethorpe Avenue, Buena Park, California 90620-1373
Telephone: 800-854-1569
www.yamaha.com

Do not return any product to the above address without a written Return Authorization issued by YAMAHA.

©2019 Yamaha Corporation of America.

Information for users on collection and disposal of old equipment:



This symbol on the products, packaging, and/or accompanying documents means that used electrical and electronic products should not be mixed with general household waste.

For proper treatment, recovery and recycling of old products, please take them to applicable collection points, in accordance with your national legislation.

By disposing of these products correctly, you will help to save valuable resources and prevent any potential negative effects on human health and the environment which could otherwise arise from inappropriate waste handling.

For more information about collection and recycling of old products, please contact your local municipality, your waste disposal service or the point of sale where you purchased the items.

For business users in the European Union:

If you wish to discard electrical and electronic equipment, please contact your dealer or supplier for further information.

Information on Disposal in other Countries outside the European Union:

This symbol is only valid in the European Union. If you wish to discard these items, please contact your local authorities or dealer and ask for the correct method of disposal.

For details of products, please contact your nearest Yamaha representative or the authorized distributor listed below.

Pour plus de détails sur les produits, veuillez-vous adresser à Yamaha ou au distributeur le plus proche de vous figurant dans la liste suivante.

Die Einzelheiten zu Produkten sind bei Ihrer unten aufgeführten Niederlassung und bei Yamaha Vertragshändlern in den jeweiligen Bestimmungsländern erhältlich.

Para detalles sobre productos, contacte su tienda Yamaha más cercana o el distribuidor autorizado que se lista debajo.

NORTH AMERICA

CANADA

Yamaha Canada Music Ltd.
135 Milner Avenue, Toronto, Ontario M1S 3R1,
Canada
Tel: +1-416-298-1311

U.S.A.

Yamaha Corporation of America
6600 Orangethorpe Avenue, Buena Park, CA 90620,
U.S.A.
Tel: +1-714-522-9011

CENTRAL & SOUTH AMERICA

MEXICO

Yamaha de México, S.A. de C.V.
Av. Insurgentes Sur 1647 Piso 9, Col. San José
Insurgentes, Delegación Benito Juárez, México,
D.F., C.P. 03900, México
Tel: +52-55-5804-0600

BRAZIL

Yamaha Musical do Brasil Ltda.
Praça Professor José Lannes, 40, Cjs 21 e 22, Brooklin
Paulista Novo CEP 04571-100 – São Paulo – SP,
Brazil
Tel: +55-11-3704-1377

ARGENTINA

**Yamaha Music Latin America, S.A.,
Sucursal Argentina**
Olga Cossetini 1553, Piso 4 Norte,
Madero Este-C1107CEK,
Buenos Aires, Argentina
Tel: +54-11-4119-7000

PANAMA AND OTHER LATIN AMERICAN REGIONS/ CARIBBEAN REGIONS

Yamaha Music Latin America, S.A.
Edificio Torre Davivienda, Piso: 20
Avenida Balboa, Marbella, Corregimiento de Bella
Vista, Ciudad de Panamá, Rep. de Panamá
Tel: +507-269-5311

EUROPE

THE UNITED KINGDOM/IRELAND

Yamaha Music Europe GmbH (UK)
Sherbourne Drive, Tilbrook, Milton Keynes,
MK7 8BL, U.K.
Tel: +44-1908-366700

GERMANY

Yamaha Music Europe GmbH
Siemensstrasse 22-34, 25462 Rellingen, Germany
Tel: +49-4101-303-0

SWITZERLAND/LIECHTENSTEIN

**Yamaha Music Europe GmbH, Branch
Switzerland in Thalwil**
Seestrasse 18a, 8800 Thalwil, Switzerland
Tel: +41-44-3878080

AUSTRIA/CROATIA/CZECH REPUBLIC/ HUNGARY/ROMANIA/SLOVAKIA/ SLOVENIA

Yamaha Music Europe GmbH, Branch Austria
Schleiersgasse 20, 1100 Wien, Austria
Tel: +43-1-60203900

POLAND

**Yamaha Music Europe
Sp.z o.o. Oddział w Polsce**
ul. Wielicka 52, 02-657 Warszawa, Poland
Tel: +48-22-880-08-88

BULGARIA

Dinacord Bulgaria LTD.
Bul. Iskarsko Schose 7 Targowski Zentar Ewropa
1528 Sofia, Bulgaria
Tel: +359-2-978-20-25

MALTA

Olimpus Music Ltd.
Valletta Road, Mosta MST9010, Malta
Tel: +356-2133-2093

NETHERLANDS/BELGIUM/ LUXEMBOURG

Yamaha Music Europe, Branch Benelux
Clarissenhof 5b, 4133 AB Vianen, The Netherlands
Tel: +31-347-358040

FRANCE

Yamaha Music Europe
7 rue Ambroise Croizat, Zone d'activités de Pariest,
77183 Croissy-Beaubourg, France
Tel: +33-1-6461-4000

ITALY

Yamaha Music Europe GmbH, Branch Italy
Via Tinelli N.67/69 20855 Gerno di Lesmo (MB),
Italy
Tel: +39-039-9065-1

SPAIN/PORTUGAL

**Yamaha Music Europe GmbH Ibérica, Sucursal
en España**
Ctra. de la Coruña km. 17,200, 28231
Las Rozas de Madrid, Spain
Tel: +34-91-639-88-88

GREECE

Philippos Nakas S.A. The Music House
19th km. Leof. Lavriou 190 02 Peania – Attiki,
Greece
Tel: +30-210-6686260

SWEDEN

**Yamaha Music Europe GmbH Germany filial
Scandinavia**
JA Wettergrensgata 1, 400 43 Göteborg, Sweden
Tel: +46-31-89-34-00

DENMARK

**Yamaha Music Denmark,
Fillial of Yamaha Music Europe GmbH, Tyskland**
Generatorvej 8C, ST. TH., 2860 Søborg, Denmark
Tel: +45-44-92-49-00

FINLAND

F-Musiikki Oy
Antaksentie 4
FI-01510 Vantaa, Finland
Tel: +358 (0)96185111

NORWAY

**Yamaha Music Europe GmbH Germany -
Norwegian Branch**
Grini Næringspark 1, 1332 Østerås, Norway
Tel: +47-6716-7800

ICELAND

Hjodfaerahusid Ehf.
Sidumula 20
IS-108 Reykjavik, Iceland
Tel: +354-525-5050

CYPRUS

Nakas Music Cyprus Ltd.
Nikis Ave 2k
1086 Nicosia
Tel: +357-22-511080
Major Music Center
21 Ali Riza Ave. Ortakoy
P.O.Box 475 Lefkoşa, Cyprus
Tel: (392) 227 9213

RUSSIA

Yamaha Music (Russia) LLC.
Room 37, entrance 7, bld. 7, Kievskaya street,
Moscow, 121059, Russia
Tel: +7-495-626-5005

OTHER EUROPEAN REGIONS

Yamaha Music Europe GmbH
Siemensstrasse 22-34, 25462 Rellingen, Germany
Tel: +49-4101-303-0

AFRICA

Yamaha Music Gulf FZE
JAFZA-16, Office 512, P.O.Box 17328,
Jebel Ali FZE, Dubai, UAE
Tel: +971-4-801-1500

MIDDLE EAST

TURKEY

**Yamaha Music Europe GmbH
Merkezi Almanya Türkiye Istanbul Şubesi**
Mor Sumbul Sokak Varyap Meridian Business
1.Blok No:1 113-114-115
Bati Atasehir Istanbul, Turkey
Tel: +90-216-275-7960

ISRAEL

RBX International Co., Ltd.
P.O Box 10245, Petach-Tikva, 49002
Tel: (972) 3-925-6900

OTHER REGIONS

Yamaha Music Gulf FZE
JAFZA-16, Office 512, P.O.Box 17328,
Jebel Ali FZE, Dubai, UAE
Tel: +971-4-801-1500

ASIA

THE PEOPLE'S REPUBLIC OF CHINA

Yamaha Music & Electronics (China) Co., Ltd.
2F, Yunhedasha, 1818 Xinzha-lu, Jingan-qu,
Shanghai, China
Tel: +86-400-051-7700

HONG KONG

Tom Lee Music Co., Ltd.
11/F., Silvercord Tower 1, 30 Canton Road,
Tsimshatsui, Kowloon, Hong Kong
Tel: +852-2737-7688

INDIA

Yamaha Music India Private Limited
P-401, JMD Megapolis, Sector-48, Sohna Road,
Gurugram-122018, Haryana, India
Tel: +91-124-485-3300

INDONESIA

PT. Yamaha Musik Indonesia (Distributor)
Yamaha Music Center Bldg. Jalan Jend. Gatot
Subroto Kav. 4, Jakarta 12930, Indonesia
Tel: +62-21-520-2577

KOREA

Yamaha Music Korea Ltd.
11F, Prudential Tower, 298, Gangnam-daero,
Gangnam-gu, Seoul, 06253, Korea
Tel: +82-2-3467-3300

MALAYSIA

Yamaha Music (Malaysia) Sdn. Bhd.
No.8, Jalan Perbandaran, Kelana Jaya, 47301
Petaling Jaya, Selangor, Malaysia
Tel: +60-3-78030900

SINGAPORE

Yamaha Music (Asia) Private Limited
Block 202 Hougang Street 21, #02-00,
Singapore 530202, Singapore
Tel: +65-6740-9200

TAIWAN

Yamaha Music & Electronics Taiwan Co., Ltd.
2F., No.1, Yuanhong Rd., Banqiao Dist.,
New Taipei City 22063, Taiwan (R.O.C.)
Tel: +886-2-7741-8888

THAILAND

Siam Music Yamaha Co., Ltd.
3, 4, 15, 16th Fl., Siam Motors Building,
891/1 Rama 1 Road, Wangmai,
Pathumwan, Bangkok 10330, Thailand
Tel: +66-2215-2622

VIETNAM

Yamaha Music Vietnam Company Limited
15th Floor, Nam A Bank Tower, 201-203 Cach
Mang Thang Tam St., Ward 4, Dist.3,
Ho Chi Minh City, Vietnam
Tel: +84-28-3818-1122

OTHER ASIAN REGIONS

[https://asia-latinamerica-mea.yamaha.com/
index.html](https://asia-latinamerica-mea.yamaha.com/index.html)

OCEANIA

AUSTRALIA

Yamaha Music Australia Pty. Ltd.
Level 1, 80 Market Street, South Melbourne,
VIC 3205 Australia
Tel: +61-3-9693-5111

NEW ZEALAND

Music Works LTD
P.O. BOX 6246 Wellesley, Auckland 4680,
New Zealand
Tel: +64-9-634-0099

REGIONS AND TRUST

TERRITORIES IN PACIFIC OCEAN
[https://asia-latinamerica-mea.yamaha.com/
index.html](https://asia-latinamerica-mea.yamaha.com/index.html)

Memo

Yamaha Global Site
<https://www.yamaha.com/>

Yamaha Downloads
<https://download.yamaha.com/>

Manual Development Group
© 2020 Yamaha Corporation
Published 12/2020

POMA*.*- **A0

VDQ4970