

# RANE SIXTY-TWO

TWO COMPUTERS, TWO USB PORTS, TWO DECKS AND A RANGE OF EFFECTS

**serato**  **SCRATCH LIVE**

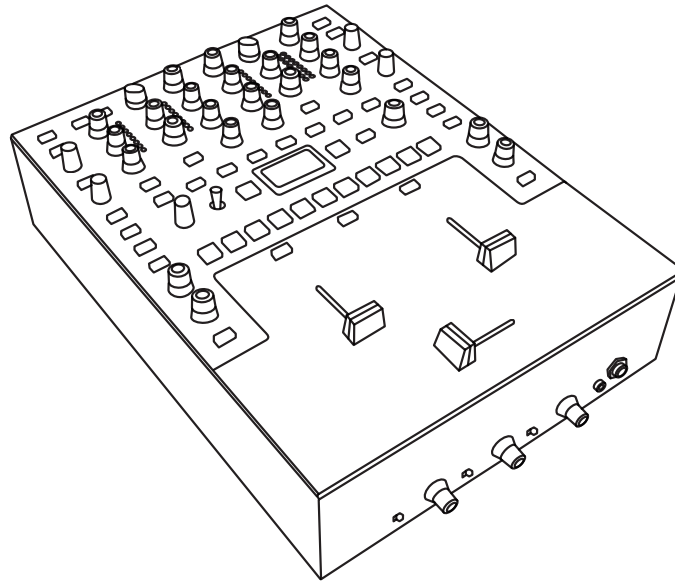

RANE SIXTY-TWO MIXER FOR SERATO SCRATCH LIVE • OPERATOR'S MANUAL 2.5.0

## Important Safety Instructions

1. Read these instructions.
2. Keep these instructions.
3. Heed all warnings.
4. Follow all instructions.
5. Do not use this apparatus near water.
6. Clean only with a dry cloth.
7. Do not block any ventilation openings. Install in accordance with manufacturer's instructions.
8. Do not install near any heat sources such as radiators, registers, stoves, or other apparatus (including amplifiers) that produce heat.
9. Do not defeat the safety purpose of the polarized or grounding type plug. A polarized plug has two blades with one wider than the other. A grounding-type plug has two blades and a third grounding prong. The wide blade or third prong is provided for your safety. If the provided plug does not fit into your outlet, consult an electrician for replacement of the obsolete outlet.
10. Protect the power cord and plug from being walked on or pinched particularly at plugs, convenience receptacles, and the point where it exits from the apparatus.
11. Only use attachments & accessories specified by Rane.
12. Use only with the cart, stand, tripod, bracket, or table specified by the manufacturer, or sold with the apparatus. When a cart is used, use caution when moving the cart/apparatus combination to avoid injury from tip-over.
13. Unplug this apparatus during lightning storms or when unused for long periods of time.
14. Refer all servicing to qualified service personnel. Servicing is required when the apparatus has been damaged in any way, such as power supply cord or plug is damaged, liquid has been spilled or objects have fallen into the apparatus, the apparatus has been exposed to rain or moisture, does not operate normally, or has been dropped.
15. The plug on the power cord is the AC mains disconnect device and must remain readily operable. To completely disconnect this apparatus from the AC

mains, disconnect the power supply cord plug from the AC receptacle.

16. This apparatus shall be connected to a mains socket outlet with a protective earthing connection.
17. When permanently connected, an all-pole mains switch with a contact separation of at least 3 mm in each pole shall be incorporated in the electrical installation of the building.
18. If rack-mounting, provide adequate ventilation. Equipment may be located above or below this apparatus, but some equipment (like large power amplifiers) may cause an unacceptable amount of hum or may generate too much heat and degrade the performance of this apparatus.

**WARNING:** To reduce the risk of fire or electric shock, do not expose this apparatus to rain or moisture. Apparatus shall not be exposed to dripping or splashing and no objects filled with liquids, such as vases, shall be placed on the apparatus.

### Warning

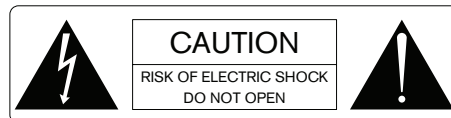

To reduce the risk of electrical shock, do not open the unit. No user serviceable parts inside. Refer servicing to qualified service personnel. The symbols shown below are internationally accepted symbols that warn of potential hazards with electrical products.



This symbol indicates that there are important operating and maintenance instructions in the literature accompanying this unit.



This symbol indicates that a dangerous voltage constituting a risk of electric shock is present within this unit.

These stickers are located on the bottom of the mixer.

**WARNING:** This product may contain chemicals known to the State of California to cause cancer, or birth defects or other reproductive harm.

## FCC Statement

This equipment has been tested and found to comply with the limits for a Class B digital device, pursuant to part 15 of the FCC Rules. These limits are designed to provide reasonable protection against harmful interference in a residential installation. This equipment generates, uses and can radiate radio frequency energy and, if not installed and used in accordance with the instructions, may cause harmful interference to radio communications. However, there is no guarantee that interference will not occur in a particular installation. If this equipment does cause harmful interference to radio or television reception, which can be determined by turning the equipment off and on, the user is encouraged to try to correct the interference by one or more of the following measures:

- Reorient or relocate the receiving antenna.
- Increase the separation between the equipment and receiver.
- Connect the equipment into an outlet on a circuit different from that to which the receiver is connected.
- Consult the dealer or an experienced radio/TV technician for help.

**CAUTION:** Changes or modifications not expressly approved by Rane Corporation could void the user's authority to operate the equipment.

This Class B digital apparatus complies with Canadian ICES-003.

Cet appareil numérique de la classe B est conforme à la norme NMB-003 du Canada.

## Copyright Notices

© 2013 Rane Corporation. All rights reserved. Scratch Live and the Scratch Live logo are trademarks of Serato. Trademarked in the U.S. and other countries. This software is based in part on the work of the Independent JPEG Group, and uses libpng code, copyright © 2000-2002 Glenn Randers-Pehrson. The Scratch Live Control Tone, the audio pressed on Scratch Live Control vinyl and Control CDs, is copyright ©2004-2013 Serato. The Control Vinyl and Control CDs are licensed for personal use only. The creation of personal backups of the Control CD is allowed, however duplicating Control CDs for commercial benefit is strictly prohibited. For avoidance of doubt the duplication or creation of Control vinyl for any use is strictly prohibited. Please respect our copyright. Windows® is a registered trademark of Microsoft Corporation in the United States and other countries. Apple, Mac, Macintosh, iTunes, Safari, QuickTime, GarageBand, and OS X are registered trademarks of Apple Inc., registered in the U.S. and other countries.

## Introduction

Please read through these operating instructions so you will know how to get the most from your Sixty-Two and the included Scratch Live software. Keep this manual in a safe place. If you ever lose it, a new copy may be downloaded at [dj.rane.com](http://dj.rane.com).

To keep up with the latest tips, and to check for Scratch Live software updates, visit the Official Scratch Live Forum at [serato.com](http://serato.com).

## Minimum System Requirements

- Available USB 2.0 port.
- 1280 x 720 screen resolution or higher.
- 2 GB RAM, more for a large library.
- Hard drive space for music: 5400 RPM minimum, 7200 RPM recommended for high resolution audio playback.

### PC

- 2.2 GHz Intel Core Duo.
- Windows XP with Service Pack 3 or higher, or Vista with Service Pack 2 or higher, or Windows 7. We recommend Windows 7 over Vista.

### Mac

- 1.83 GHz Intel Core Duo.
- OSX 10.5.8 or higher.

**PLEASE NOTE:** These are the minimum requirements to run Serato Scratch Live without optional plugins. For best performance or when using optional plugins we recommend you use a higher spec computer. Please see the Minimum Specs at [serato.com/scratchlive](http://serato.com/scratchlive).

## Check List

These items are included in the box:

- 1 Sixty-Two Mixer.
- Scratch Live software install disc.
- 2 (two) control CDs in two sleeves.
- 2 (two) control records.
- 2 USB cables.
- IEC C5 line cord.
- Quick Start Guide.
- This manual.

## Wear Parts

The Sixty-Two Mixer contains no wear parts. The vinyl records and CDs are wear parts as described in “Limited Warranties” on page 58.

# Contents

Important Safety Instructions	2	<b>Control Strip Controls</b>	<b>9</b>	<b>Playback Control</b>	<b>21</b>
Warning	2	Library Browse	9	The Control Record	21
FCC Statement	2	Loops Manual / Auto	10	The Control CD	21
Copyright Notices	3	Manual Loop Controls	10	Vinyl Scroll	21
Introduction	3	Auto Loop Controls	10		
Minimum System Requirements	3	Cues / Samples control	10	<b>Main Screen Overview</b>	<b>21</b>
Check List	3	Cue Points	10	Virtual Deck	21
Wear Parts	3	Sample Player (SP-6) Triggers	10	Visual Aids	22
		<b>FlexFX</b>	<b>11</b>	Tempo Matching Display	22
		Internal Audio Effects	12	Track Overview Display	22
		Effects Parameter Table	13	Main Waveform Display	22
				Beat Matching Display	22
		<b>Core Audio and ASIO Drivers</b>	<b>14</b>	Master Gain	22
		ASIO (Windows)	14	33 / 45 Speeds	22
		Core Audio (Macintosh)	14	Tracking Indicator	23
		Driver Control Panel	14	Tap Tempo	23
		Factory Defaults	15	Eject	23
				Key Lock	23
		<b>Scratch Live: Getting started</b>	<b>16</b>	Repeat	23
		System Overview	16	Censor	23
		Connecting the Sixty-Two	16	Autoplay	23
		Turntable Setup	16	Track Gain	23
		CD Player Setup	16	USB Dropout Indicator	23
		<b>Installing Scratch Live</b>	<b>16</b>	<b>Display Modes</b>	<b>24</b>
		Mac	16		
		Windows	17	<b>Library Views</b>	<b>24</b>
		Additional Windows Drivers	17		
		Starting the Software	17	<b>Scratch Live Modes</b>	<b>24</b>
		Installing More Than One Version	17	Absolute Mode	25
		Firmware Check	17	Relative Mode	25
		Using the Tool Tips	17	Internal Mode	25
				Temporary Cue	26
		<b>Calibrating Scratch Live</b>	<b>18</b>	More Controls	26
		The Noise Threshold	18		
		The Scopes	18	<b>Cue Points</b>	<b>26</b>
		Calibration Troubleshooting	18	Setting Cue Points	26
				Enable Hot Cues	27
		<b>Importing and Playing Music</b>	<b>19</b>	Triggering Cue Points	27
		Importing Your Music	19	Editing Cue Points	27
		Supported File Types	19	Customizing Cue Points	27
		Playing Music	19		
		Track Display	19	<b>Looping</b>	<b>27</b>
				Auto-Looping	27
		<b>Whitelabel.net</b>	<b>20</b>	The A-Slot	28
				Loop Roll	28
		<b>Preparing Your Files</b>	<b>20</b>	Loop Roll with MIDI	28
		How to Analyze Files	20		
		About Corrupt Files	20		
		Set Auto BPM	20		
		The Offline Player	20		
<b>Sixty-Two Mixer Overview</b>	<b>6</b>				
<b>Connecting the Mixer</b>	<b>6</b>				
Power Supply	6				
Analog Inputs	6				
Analog Outputs	6				
USB Audio	7				
<b>Mixer Controls</b>	<b>8</b>				
<b>Program Channels</b>	<b>8</b>				
Source Selector	8				
Level	8				
Pan	8				
Tone Controls	8				
Filter	8				
FlexFX	9				
Headphone Cue	9				
Channel Faders & Crossfader	9				
Channel Meters	9				
 AUX	9				
Mic Input	9				
Session In and Out	9				
Main and Booth	9				
Headphones	9				

<b>SP-6 Sample Player</b>	<b>28</b>	<b>File Management</b>	<b>38</b>	<b>Library</b>	<b>44</b>
Loading the SP-6	29	Rescan ID3 Tags	38	Read iTunes Library	44
Playing Samples	29	Relocate Lost Files	38	Protect Library	44
SP-6 Instant Doubles	29	Deleting Crates and Tracks	38	Customize Crate Views	44
SP-6 Play Modes	29	Copy & Move Files & Folders	38	Center On Selected Song	44
SP-6 Pitch Controls	29	Copy & Move Crates	38	Show All File Types	44
SP-6 'Play From' Selector	29	Scratch Live Backup	38	Include Subcrate Tracks	45
SP-6 Track Overviews	30			AutoFill Overviews	45
SP-6 Slot Volumes	30	<b>Recording</b>	<b>39</b>	Font Size	45
SP-6 Output Selector	30	Record Gain Knob	39	Album Art Size	45
Individual Output Selectors	30	Sampling From Vinyl	39	<b>Display</b>	<b>45</b>
SP-6 Sample Banks	30			Maximum Screen Updates	45
SP-6 Mute Buttons	30	<b>Mixing With One Turntable Or CD</b>		Audio Cache	45
SP-6 MIDI	30	<b>Player</b>	<b>39</b>	Show Album Art On Deck	45
				<b>Plugins</b>	<b>45</b>
<b>DJ-FX Plugin</b>	<b>30</b>	<b>Two Computer Connection</b>	<b>40</b>	Enable SP-6 Sample Player	45
Ultra Knob Mode	30			Enable DJ-FX	45
Super Knob Mode	31	<b>Keyboard Shortcuts</b>	<b>41</b>	Enable Mixer DJ-FX Send	45
Effects BPM Multiplier	31			Enable Serato Playlists	45
Deck Assign	31	<b>Additional Setup</b>	<b>42</b>	Enable Live Playlists	45
Show Parameters	31	<b>Hardware: General</b>	<b>42</b>	Serato Video	45
Macro Edit Mode	31	USB Buffer Size (Latency)	42	Serato Remote	45
		Updating Firmware	42		
<b>MIDI Control</b>	<b>32</b>	Control Source	42	<b>Troubleshooting and FAQ</b>	<b>46</b>
MIDI Controller Setup	32	MIDI Assign of Mixer Controls	42		
Assigning Controls	32	Input Select Status	42	<b>Corrupt File Descriptions and</b>	
MIDI Output Lighting	32	Recording Bit Depth	42	<b>Diagnoses</b>	<b>47</b>
MIDI Platters	32	<b>Hardware: Effects</b>	<b>42</b>		
Assign MIDI to Other Controls	32	Filter	42	<b>Scope Reading and Fixes</b>	<b>48</b>
Ctrl-Click Functionality	32	Flanger	42		
Presets	32	Echo	42	<b>Appendix</b>	<b>50</b>
Native Controller Support	33	Channel Filters	42	Sixty-Two Specifications	50
MIDI Devices	33	<b>Playback</b>	<b>43</b>	Battle Bridge Accessory	51
MIDI Mapping	33	Track End Warning	43	Magnetic Fader Maintenance	52
MIDI Assignments	34	Playback Keys Use Shift	43	Fader Assembly Removal	52
MIDI Layers	34	Lock Playing Deck	43	Fader Cleaning	52
		Sort Cues Chronologically	43	Fader Calibration	52
<b>Organizing Your Music</b>	<b>34</b>	Enable Hot Cues	43	<b>MIDI Implementation</b>	<b>53</b>
Grouping Tracks into Crates	34	Use Auto Gain	43	MIDI Note ON/OFF Chart	53
Subcrates	34	Hi-Fi Resampler	43	MIDI Control Change Chart	55
Smart Crates	34	Play From Start	43		
Sorting Your Files	35	Instant Doubles	43	<b>Declaration of Conformity</b>	<b>57</b>
Using the Song Browser	35	Play From First Cue Point	43		
Searching	35	Braking	43	<b>Limited Warranties</b>	<b>58</b>
Prepare Window	35	Audio Output	43		
History	35	<b>Vinyl Control</b>	<b>44</b>		
Serato Playlists	36	Adjust Loops with Vinyl	44		
Uploading Serato Playlists	36	Next Song On Flip	44		
Live Playlists	36	Enable Vinyl Scroll	44		
Editing ID3 tags	37	Reverse Vinyl Scroll	44		
Library Zoom	37	Vinyl Scroll Speed	44		
Display Album Art	37	Drop To Absolute Position	44		
Adding Album Art	37	Drop To Cue Points	44		
Status Icons	37	Vinyl Start Offset	44		

## Sixty-Two Mixer Overview

- Includes Serato Scratch Live, ASIO and Core Audio Drivers.
- Independently control Library, Cues, Loops and Samples on two computers with more than 40 software controls.
- Each of the two USB ports support 6 stereo record and 4 stereo playback channels.
- Record channels support:
  - Vinyl control signal for 2 Virtual Decks.
  - Record PGM 1 and PGM 2 post-fader.
  - Record the Main Mix or the Mic.
  - FlexFX USB Insert Send to computer.
- Playback channels support:
  - Playback for 2 Virtual Decks.
  - USB Aux playback for sample player.
  - FlexFX USB Insert Return from computer.
- 32-bit floating point audio sampled at 48 kHz.
- PGM controls include:
  - Level, 3-band full-cut EQ, L/R Pan.
  - HP/LP Filter with resonance adjust.
  - FlexFX and Headphone Cue assigns.
  - Magnetic faders with contour and reverse.
- Mic input with FlexFX, tone and On/Over.
- Advanced post-fader FlexFX Loop:
  - Internal Effects engine with:
    - Filter, Flanger, Phaser, Echo, Robot, Reverb.
  - MIDI Beat-Clock track and generate.
  - BPM effects sync with Scratch Live.
  - TAP time encode and beat multiply.
  - External analog insert for effects.
  - USB Insert for post-fader soft effects.
- USB Aux input for SP-6 sample player.
- Main Mix, Booth and Session In/Out.
- Headphone monitor with split cueing.

## Connecting the Mixer

### Power Supply

The Sixty-Two features an internal universal switching power supply that operates on any AC mains 100 to 240 VAC, 50 or 60 Hz (most places in the world). All that is required when traveling is the appropriate IEC line cord which is usually readily available. The universal supply is a major plus for the traveling DJ. **Leave the power unplugged until everything else is connected!**

### Analog Inputs

Four Phono / CD inputs are provided by RCA jacks. These may be set for PH or CD using rear panel slide switches. Analog inputs 1 and 2 are used by Program 1 (PGM 1). Analog inputs 3 and 4 are used by Program 2 (PGM 2). Analog Input 1 or 2 may be selected in Scratch Live software as the Digital Vinyl Simulation (DVS) signal for the Left Virtual Deck or for recording on USB stereo pair 5-6. Analog Input 3 or 4 may be selected in software as the DVS signal for the Right Virtual Deck or for recording on USB stereo pair 7-8. Set any unused inputs to CD. Connect your turntable ground wires to the ground posts provided on the rear panel when using PH inputs.

One stereo Session Input is available on a pair of RCA input jacks. This input may be used for connecting two mixers together or as a general purpose auxiliary input to the mixer.

The Mic Input will accept an XLR 3-pin plug, a balanced 1/4" TRS (tip-ring-sleeve) plug or an unbalanced TS (tip-sleeve) plug. This input may be set for

Microphone or Line level using the Mic / Line switch on the rear panel. Set this to Line when connecting a wireless receiver.

A stereo FlexFX Loop Return input is on a pair of unbalanced 1/4" TS jacks. These inputs are automatically configured for mono when only one cable is connected to the left or right Return input. The FlexFX Return input is normally used in conjunction with the FlexFX Send output to connect an outboard analog effects processor.

### Analog Outputs

There are five stereo analog outputs available on the mixer: Main Out, Booth Out, Session Out, FlexFX Send and Headphone Monitor.

- **Main Out** is on a pair of balanced XLR jacks with pin 2 "hot" per AES standards.
- **Booth Out** is on a pair of balanced 1/4" TRS jacks.
- **Session Out** is available on a pair of unbalanced RCA jacks.
- **FlexFX Loop Send** output is available on a pair of unbalanced 1/4" inch TS jacks. For a mono FlexFX Send, use the **Left** output. The FlexFX Send output is normally used in conjunction with the **FlexFX Loop Return** input to connect outboard effects.
- **Headphones** output is available on both 1/4" TRS and 3.5 mm jacks.

The Main, Booth and Session outputs come from the same "Main Mix" signal. Main, Booth and Session outputs each have their own Level control. Because all signals are identical, users may use any of these outputs as the "Main" output if a different cable type is required for system connection.

Rane recommends balanced wiring for the strongest signal and rejection of hum and noise. If your cable to the destination is less than 10 feet (3 meters), you can often get away with an unbalanced cable. See the RaneNote "[Sound System Interconnection](#)" at rane.com for cable wiring recommendations.

## USB Audio



There are six stereo record channels and four stereo playback channels. These channels are simultaneously available on two USB ports, allowing two computers to share the device. This allows two DJs to play together and supports uninterrupted transitions from one DJ to another.

The Sixty-Two is a dual personality device. When using Serato Scratch Live, proprietary Serato Audio Research drivers are used in place of ASIO (windows) and Core Audio (Mac) drivers supplied by Rane. These Rane drivers are used when Scratch Live is not running.

Rane ASIO and Core Audio drivers allow the Sixty-Two to act as a 12-record 8-playback USB sound card for use with multiple third-party software applications that support ASIO or Core Audio. ASIO and Core Audio drivers are multi-client, meaning they allow multiple applications on a computer to share the device at the same time. ASIO and Core Audio drivers are not available when Scratch Live is running.

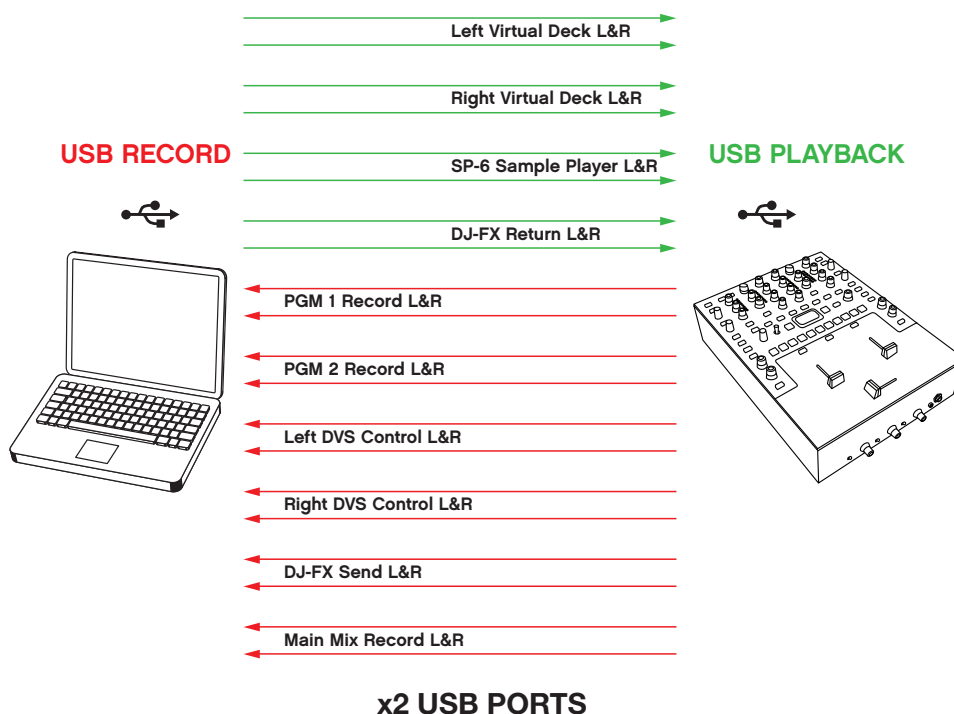
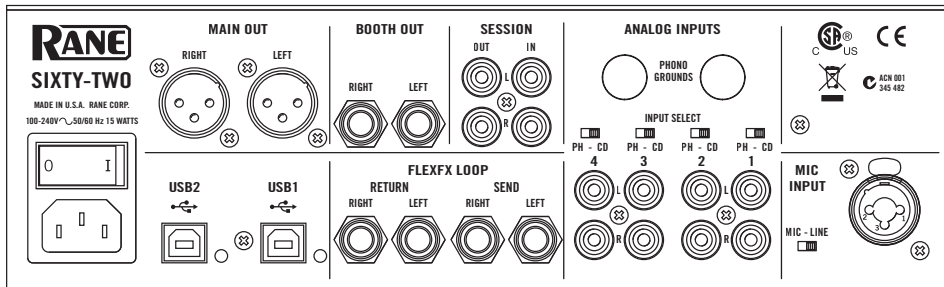
The Sixty-Two has two USB ports, allowing simultaneous connection of two computers. Each port is completely independent. It is possible to run Scratch Live using proprietary drivers on one computer while running third party software using ASIO or Core Audio on the other, Mac or PC, in any combination.



USB Playback	Stereo Pair	Scratch Live Description	Mixer Use
<b>1</b>	1-2	Left Virtual Deck Output	Select as PGM 1 Source from USB A or USB B
<b>2</b>	3-4	Right Virtual Deck Output	Select as PGM 2 Source from USB A or USB B
<b>3</b>	5-6	SP-6 Output Option	USB AUX Source (sum of USB A and USB B)
<b>4</b>	7-8	DJ Effects Return to the Mixer	FlexFX  Insert Return (sum of USB A and USB B)
<b>USB Record</b>			
<b>1</b>	1-2	Record Source PGM 1	PGM-1 Post Fader and Post Crossfader Output
<b>2</b>	3-4	Record Source PGM 2	PGM-2 Post Fader and Post Crossfader Output
<b>3</b>	5-6	Record or DVS Control for Left Deck	Selects PH/CD 1 or PH/CD 2 in Control Panel
<b>4</b>	7-8	Record or DVS Control for Right Deck	Selects PH/CD 3 or PH/CD 4 in Control Panel
<b>5</b>	9-10	DJ Effects Send from the Mixer	FlexFX  Insert Send
<b>6</b>	11-12	Record the Main Mix or Mic	Select Main Mix or Mic in the Control Panel

# Mixer Controls

## Program Channels

Two Program channels, or buses, have nearly identical controls with the exception of the Source selectors.

### Source Selector

The **SOURCE** selector for PGM 1 selects one of four sources:

- Left Virtual Deck (USB stereo playback pair 1-2) from USB A.
  - Also assigns the MIDI controls for the Left-Deck software and PGM 1 mixer to USB A.
- PH / CD 1 (THRU): Set to **PH** or **CD** with the rear panel switch.
  - When selected in software, this input is available on USB record 5-6 for use as the DVS control signal or for audio recording. To select this control source in Serato Scratch Live: go to Setup > Hardware > Control Source > PGM 1 and select "1". See "Control Source" on page 42.
- PH / CD 2 (THRU): Set to **PH** or **CD** with the rear panel switch.
  - When selected in software, this input is available on USB record 5-6 for use as the DVS control signal or for audio recording. To select this as the control source in Serato Scratch Live: go to Setup > Hardware > Control Source > PGM 1 and select "2".
- Left Virtual Deck (USB stereo playback pair 1-2) from USB B.
  - Also assigns the MIDI controls for the Left-Deck software and PGM 1 mixer to USB B.

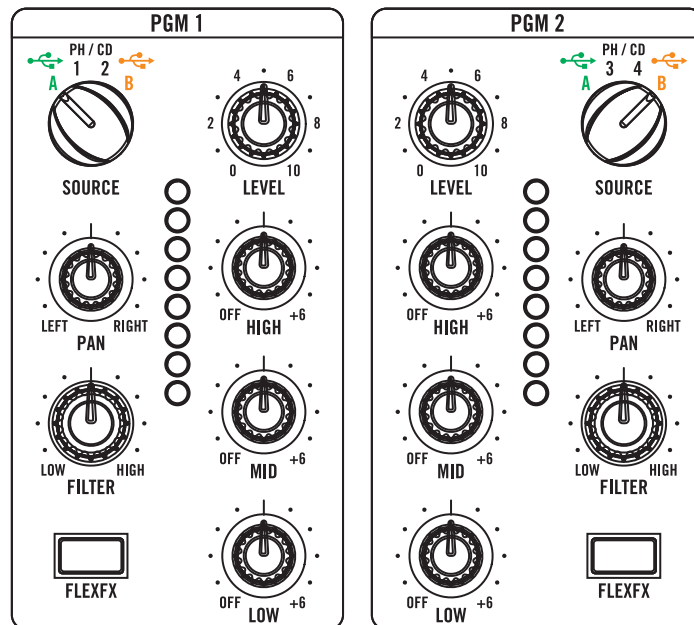

The **SOURCE** selector for PGM 2 selects one of four sources:

- Right Virtual Deck (USB stereo playback pair 3-4) from USB A.
  - Also assigns the MIDI controls for the Right-Deck software and PGM 2 mixer to USB A.
- PH / CD 3 (THRU): Set to **PH** or **CD** with the rear panel switch.
  - When selected in software, this input is available on USB record 7-8 for use as the DVS control signal or for audio recording. To select this control source in Serato Scratch Live: go to Setup > Hardware > Control Source > PGM 2 and select "3".
- PH / CD 4 (THRU): Set to **PH** or **CD** with the rear panel switch.
  - When selected in software, this input is available on USB record 7-8 for use as the DVS control signal or for audio recording. To select this control source in Serato Scratch Live: go to Setup > Hardware > Control Source > PGM 2 and select "4".
- Right Virtual Deck (USB stereo playback pair 3-4) from USB B.
  - Also assigns the MIDI controls for the Left-Deck software and PGM 2 mixer to USB B.

### Level

**LEVEL** controls adjust the input gain from off to +15 dB. Unity gain (no boost or cut) is at 12 o'clock.

### Pan

Left / Right **PAN** controls adjust the balance of left and right signals. Left and right are equal at 12 o'clock .

### Tone Controls

**HIGH**, **MID** and **LOW** full-cut tone controls adjust the frequency response from off to +6 dB. Unity gain (no boost or cut) is at 12 o'clock.

### Filter

The **FILTER** sweeps from Low-Pass to High-Pass. Set to 12 o'clock for a flat frequency response. Moving the filter toward the **LOW** position progressively reduces high-frequencies. Moving the filter toward the **HIGH** position progressively reduces low-frequencies. The Resonance or Q of the Filter can be adjusted in Scratch Live: go to Setup > Hardware > to set the Resonance. High resonance adds a "zip" effect to the Filter when it is moved. Low resonance is best when the Filter is used for mixing.



## FlexFX

The **FLEXFX** button assigns a PGM channel to the FlexFX bus where internal, external analog or software effects via USB may be inserted. Enable Serato Scratch Live DJ Effects by going to Setup > Plugins > DJ-FX and click “Enable mixer DJ-FX send.”

The FlexFX loop allows any combination of PGM 1, PGM 2, MIC or USB AUX to be assigned with the option to insert internal effects, external analog effects or software effects via USB.

## Headphone Cue

Headphone **CUE** assigns a signal to the headphone monitor. Headphone CUE controls operate as solo or radio-button controls. This means engaging a headphone CUE turns all the other headphone CUE controls off. You can select more than one at a time by simultaneously pressing more than one CUE.

## Channel Faders & Crossfader

These faders use magnetic non-contact mechanisms with no noise and no bleed. Each fader has **REVERSE** and **CONTOUR** controls on the front panel.

## Channel Meters

Each PGM channel has a mono meter to assist in setting levels. These meters are quasi-peak with peak hold. The goal is to stay out of the red.

## AUX

This digital input is on USB playback stereo pair 5-6 and is normally used for the Serato Scratch Live SP-6 sample player.

To enable the SP-6 player, go to Setup > Plugins > SP-6 Sample Player and click “enable SP-6 Sample Player Plugin.”

To assign the SP-6 Sample Player to  **AUX**, click the SP-6 tab on the main software screen and select “A” as the SP-6 output.

This  **AUX** input has it’s own **LEVEL**,



**FILTER** and **FLEXFX** assign. **CUE** for **USB AUX** is in the center just below the **SAMPLES** row of buttons.

## Mic Input

This Mic input on a XLR/TRS combo jack has **LEVEL**, **HIGH** and **LOW** tone controls, **FLEXFX** assign and a meter. Select **MIC** or **LINE** level using the rear panel switch. **LINE** is usually correct for wireless mic receivers.

**MIC ON** turns the mic input on without ducking other inputs.

**MIC OVER** momentarily turns the microphone on, and ducks other inputs by 10 dB (about 1/3).

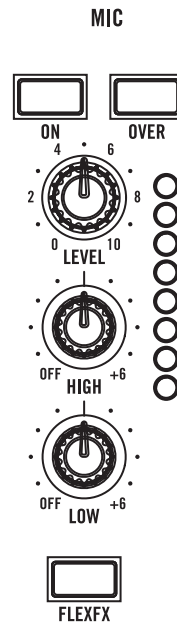

## Session In and Out

This SESSION IN has it’s own level control and may be used as a general purpose analog AUX input from RCA jacks. **SESSION IN** and **SESSION OUT** are typically used to chain mixers together.

## Main and Booth

The Main and Booth outputs each have their own Level control. The Main outputs use balanced XLR connectors and the Booth outputs use balanced 1/4” TRS connectors. Since the Main, Booth and Session Outputs have the same mix, you can run any of them to your main amplifier if the proper cables are not available.

The main mix has a quasi-peak stereo meter with peak hold.

## Headphones



The Headphone Monitor provides stereo or mono split-cue operation.



- In Stereo operation, the **PAN** control pans between stereo Cue and stereo Main Mix.
- In **SPLIT CUE** operation, the **PAN** control pans between Mono Cue in the left ear and mono Main Mix in the right ear.

- Individual Cue buttons are provided for PGM 1, PGM 2, USB AUX and FlexFX Loop.
- The Headphone Level control sets the level in the front panel 3.5 mm and 1/4” output jacks.

## Control Strip Controls

The Sixty-Two Mixer has dedicated Scratch Live software controls for the Left Virtual Deck and Right Virtual Deck. The mixer has two high-speed USB ports, USB A and USB B. Virtual Deck and associated PGM controls are assigned to USB A or USB B using the PGM Input Source selectors.

When  **A** is selected for PGM 1, the **SP-6 ASSIGN** button at the top of the **left-hand** control strip turns **GREEN** to coincide with the silk-screen color for **USB A**. When  **B** is selected, the **SP-6 ASSIGN** button turns **ORANGE** to coincide with the color for **USB B**.

When  **A** is selected for PGM 2, the **SP-6 ASSIGN** button at the top of the **right-hand** control strip turns **GREEN** to coincide with the silk-screen color for **USB A**. When  **B** is selected, the **SP-6 ASSIGN** button turns **ORANGE** to coincide with the color for **USB B**.

The MIDI controls are only sent to the selected port, allowing completely independent Library Browsing, Cue, Loop and Sample control for each USB port. MIDI controls not dedicated to a channel strip, such as SP-6 player controls, are assigned to the Left or Right control-strip using the **SP-6 ASSIGN** control.

## Library Browse

**BACK** button: Switches the focus between the Crate and Library area in Scratch Live. If you have any panels open in Serato Scratch Live, the **BACK** button will also move the focus between this and the Crate and Library areas.

**SCROLL / LOAD** encoder: Rotate the knob to scroll through the Crate / Library panel currently in focus. When the focus is in the Crate area, pressing the knob displays the contents of the selected Crate and moves the focus into the Library area. When the focus is in the Library area, pressing

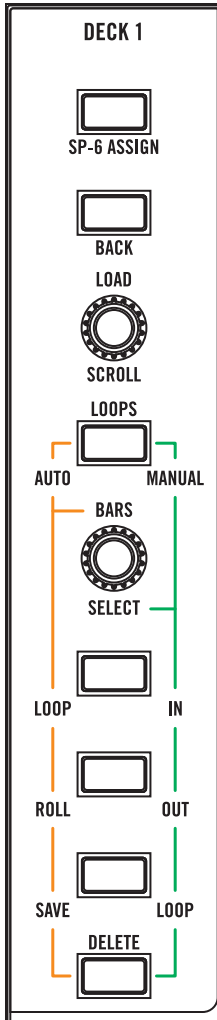

the knob loads the selected track to the Virtual Deck. Double-pressing will load an instant double to this Deck from the opposite Deck.

**Loops Manual / Auto**

**MANUAL / AUTO** button toggles the state of the Loop controls between Manual and Auto Loop mode. In Manual mode, the **LOOP** buttons light **GREEN** to correspond with the **GREEN** lines by the **LOOP** controls. In Auto mode, the buttons are lit **ORANGE** to correspond with the **ORANGE** lines.

**Manual Loop Controls**

When Manual Loop mode is selected, loop control buttons are illuminated **GREEN**. Loop buttons flash during loop playback. **SELECT** - Selects a loop slot in Scratch Live when the encoder is pressed. **IN** - Sets a loop in point. **OUT** - Sets a loop out point. **LOOP** - Turns a loop on or off. **DELETE** - Allows you to delete a loop. Press Delete and the Loop button now glows **ORANGE**. Next, use the **SELECT** knob to select the loop to be deleted then press the flashing **LOOP** button.

**Auto Loop Controls**

When Auto loop mode is selected, loop control buttons are illuminated **ORANGE**. **BARS** - Selects the auto loop length in Scratch Live. This can be adjusted while an auto loop is already looping as an effect. **LOOP** - Performs an auto loop of the number of Bars selected. **ROLL** - Performs a loop roll of the number of Bars selected. **SAVE** - Saves the current loop to an available loop slot in Scratch Live.

**Cues / Samples control**

The **CUES / SAMPLES** button toggles the ten **CUE** buttons between **CUES** and **SAMPLES** modes.

In **CUE** mode, the **CUES / SAMPLES** button is **ORANGE** and the Cue buttons are **GREEN**. There are five Cue buttons dedicated to the Left Virtual Deck and five dedicated to the Right Virtual Deck, numbered above each button.

In **SAMPLES** mode, the **CUES / SAMPLES** button is **RED**, the four Bank buttons **A, B, C** and **D** are **ORANGE** and the six Sample buttons are **GREEN**. Sample buttons are assigned to **USB A** or **USB B** using the **SP-6 ASSIGN** button at the top of each control strip. See **“Control Strip Controls”** on page 9.

**Cue Points**

In **CUE** mode, you can set and trigger five cue points for each Virtual Deck using the Cue buttons. If a Cue is set in Scratch Live, a Cue button is lit bright **GREEN**, and pressing it will trigger the corresponding Cue point in Scratch Live. If a corresponding Cue point is not set, the button will be dim **GREEN** and pressing it will set a new cue point. You can delete a Cue point in Scratch Live by pressing and holding the **DELETE** button in the active control strip, then pressing the corresponding Cue button. see **“Cue Points”** on page 26.

**Sample Player (SP-6) Triggers**

In **SAMPLES** mode, you can trigger six samples in each of four banks. Select Bank A, B, C or D. An **ORANGE** Bank button is brightly lit if any of the six slots in that bank have a track loaded, and that Bank is currently selected. When a bank is selected, any **GREEN** Sample button with a track loaded in the corresponding slot is brightly lit. The button flashes while its sample is playing. The Play behavior follows the behavior selected in Scratch Live. Sample playback can be assigned to the Left Virtual Deck, Right Virtual Deck or **AUX**. The Sixty-Two has a dedicated USB AUX input for the sample player typically used for SP-6 playback.

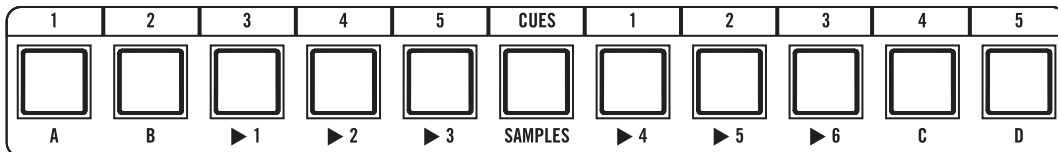
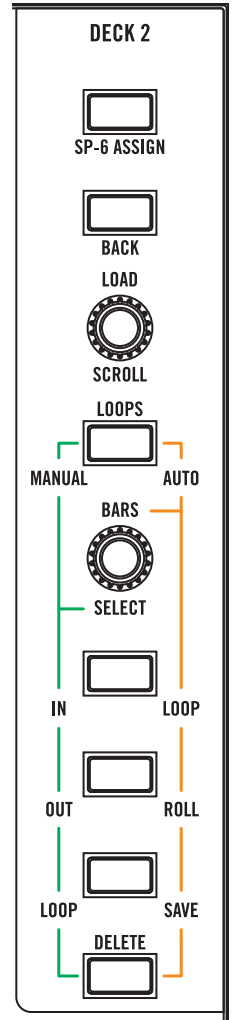

When two USB ports are in use, the **SP-6 ASSIGN** button at the top of each control strip determines which computer the SP-6 player controls are assigned to. Audio from both USB ports is summed in the mixer. See **“SP-6 Sample Player” on page 28**.

## FlexFX





The FlexFX Bus in the Sixty-Two works differently than a typical effects insert loop. This architecture is very flexible and opens up many new possibilities not possible with simple effect insert designs found on other mixers.

The FlexFX Bus is more like an auxiliary bus that can have multiple signals assigned to it. Signals assigned to the bus may then have internal effects, external analog effects and external USB effects applied in any combination. The order of processing in the FlexFX Bus is shown in the graphic below.

1. FLEXFX buttons for PGM 1, PGM 2, MIC and  AUX assign signals to the FlexFX Bus (BRIGHT BLUE) or the Main Mix (DIM BLUE). This allows assigning multiple inputs to the FlexFX Bus and/or changing the assignment without interrupting audio.

2. The six effect buttons both turn on and sync an internal effect. By keeping this separate from the effects ON button, it is possible to turn on, sync and cue effects before you hear the Wet signal in the Main Mix. Only one internal effect is selected at a time. Having six independent buttons, it is possible to drum in different effects without interruption.

3. EXT. INSERT is turned on/off with a separate button. The external analog insert can be used with internal effects and the  INSERT or independently. **NOTE: If no external connection is made to the FLEXFX LOOP RETURN jack, the signal will be interrupted when the EXT. INSERT button is turned on.**

4. The  INSERT is turned on/off with a separate button, and can be used with internal effects, the EXT. INSERT or independently. The  INSERT uses USB record pair 9-10 for the Send and USB playback pair 7-8 for the Return. Using the  INSERT generally requires a low latency setting. **NOTE: Assign a PGM channel or signal to FLEXFX before engaging the  INSERT button to avoid audible artifacts.**

In the setup screen, both DJ-FX and Enable Mixer DJ-FX Send must be checked to use the  INSERT button. See **“Enable DJ-FX” on page 45**, and **“Enable Mixer DJ-FX Send” on page 45**.

**NOTE: If no connection is made in Scratch Live between the USB send and USB return or “Enable Mixer DJ-FX send” is not checked in Scratch Live, the signal will be interrupted when the  INSERT button is turned on.**

5. The FlexFX CUE is after the internal effects insert, analog external insert, USB insert and before the effects ON function. This allows cueing a Wet signal while listening to the Dry signal before turning the effect ON.

6. When effect ON is not engaged, internal effects insert, analog external insert and USB insert points are bypassed, and any signal assigned to the FlexFX Loop is simply summed into the main mix. This allows you to CUE the Wet signal before the Wet signal is heard in the Main Mix.

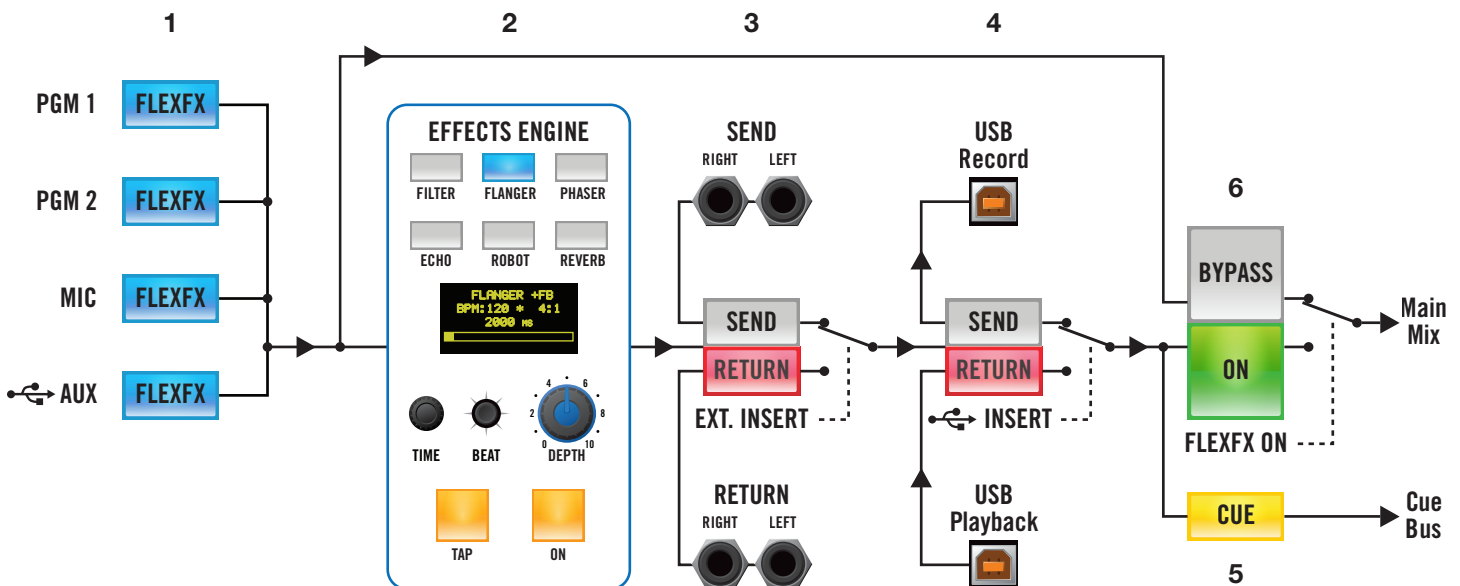

**Internal Audio Effects**

The internal effects engine is located in the FlexFX Loop. This allows any combination of **PGM 1**, **PGM 2**, **MIC** and **AUX** to be assigned to an effect. Individual effects are turned on/off using the six effects buttons. **EXT. INSERT** and **INSERT** are also engaged independently. The FlexFX Loop (which includes the External Insert and the USB Insert) is turned On/Off with the FlexFX **ON** button (off bypasses the loop).

The six built-in effects are:

- **FILTER**      • **FLANGER**      • **PHASER**
- **HOLD ECHO**   • **ROBOT**            • **REVERB**

**General Behavior**

- The effect multiplier is saved for each effect.
- Changing BPM for one effect changes the BPM for all effects.
- Tapping the BPM requires at least two taps.
- Changing the Beat multiplier results in an immediate change in the effect time.
- Changing the effect BPM adjusts the multiplier for other effects so that the new multiplier is as close as possible to the saved effect time.

**Effects Display, BPM Source and Match Indicator**

The effects display shows the name of the current effect, BPM, MIDI Beat-Clock source, Beat Multiplier and Time. A bar graph represents the effect time relative to its range. If no effect is selected, the information for the last effect is displayed. The display for the Robot and Reverb is somewhat different as outlined below.

There four possible BPM sources:

- (\*) Manual Tap
- (S) Scratch Live
- (A) **USB A** Beat-Clock,
- (B) **USB B** Beat-Clock.

To change the BPM source, press and hold the **TAP** button and use the **BEAT** joystick to step through the sources. If a new BPM is manually tapped in or the time is manually altered, the BPM source returns to (\*) Manual.

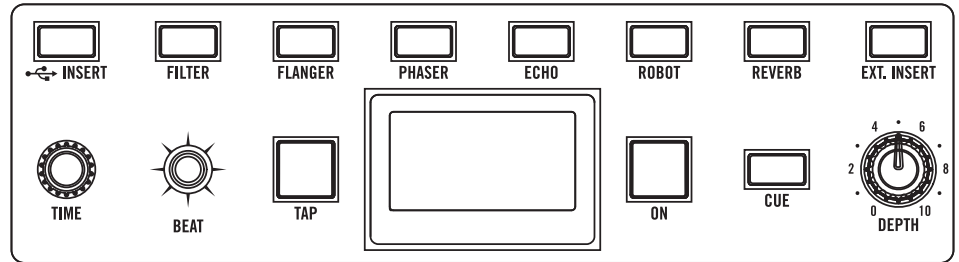

The effect time is normally a product of the BPM and the Beat Multiplier. If the right arrow **▶** or left arrow **◀** appears, there is an inequality between the BPM\*Beat and Time. The arrow indicates which way to adjust the Beat Multiplier to correct the inequality and get the closest possible time. If the BPM source is displayed (\*, S, A, B), the BPM\*Beat matches the displayed Time.

For example, 120 BPM with a 4:1 Beat Multiplier would result in an effect Time of 2000 ms. If the Time is adjusted to a different value, such as 2097 ms, an arrow indicates that the product of the displayed BPM and Beat Multiplier does not result in the displayed effect Time. For this example, 2000 ms is below 2097 ms. In this case, moving the **BEAT** joystick left or down snaps to 120 \* 4:1 and changes the time to 2000 ms.

A flashing Beat Multiplier indicates that the Time required to match the current BPM\*Beat product is out of range. For an echo example, if a BPM of 60 is used with a Beat Multiplier of 8, the resulting time is 8000 milliseconds. If the multiplier is set to 16, the resulting time would be 16000 milliseconds, which is out of range. In this case, the time remains at 8000 milliseconds and the multiplier flashes.

**Effects Synchronization**

This mixer can synchronize its internal effects to four sources as described in the preceding section. The desired clock source is selected by holding down the **TAP** button and pushing the **BEAT** joystick up/right or down/left. The selected source (\*, S, A, B) is displayed just following the BPM number. Manually tapping a BPM forces the selection to (\*) Manual.

Pressing a **FLEXFX** button with no other **FLEXFX** button engaged, with a BPM-tagged song playing in Scratch Live on that channel, forces the clock source to (S) Scratch Live. The mixer will continue to track the Scratch Live BPM until a new BPM is manually tapped or a new clock source is selected. When one of S, A, or B is selected, the clock source indicator will flash when the mixer is actively following the selected clock.

At any point the BPM and BPM source can be locked. By clicking down on the Joystick, the current BPM is frozen and the BPM source is set to (\*) Manual and locked. The BPM label on the display flashes to indicate that the BPM source has been locked. The mixer will not change the BPM or BPM source until the user manually enters new BPM or time information, changes the BPM source, or unlocks the BPM by clicking down once more on the Joystick.

Regardless of the clock source, the mixer broadcasts the current MIDI Beat-Clock to both USB ports when the Send MIDI Beat Clock option is selected in the MIDI Configuration page of the driver control panel. Both USB ports will also echo out any system real-time messages from the host computer. See “Core Audio and ASIO Drivers” on page 14.

## Effects Parameter Table

Effect	Depth Knob	Time Encoder	Tap Button	Beat Joystick	Control Panel Option*
<b>Filter</b>	Adjusts the strength of the effect.	Adjusts the LFO time independent of the current BPM and Beat Multiplier. <ul style="list-style-type: none"> <li>• Holding down the <b>TAP</b> button and turning the <b>TIME</b> encoder adjusts the BPM.</li> <li>• Pressing the <b>TIME</b> encoder re-syncs the effect.</li> </ul>	The <b>TAP</b> button manually enters a new BPM. <ul style="list-style-type: none"> <li>• A minimum of two taps is required to get a new BPM.</li> <li>• Manually tapping in a BPM switches the BPM source to (*) Manual.</li> </ul>	Adjusts the BPM multiplier to change the number of bars. <ul style="list-style-type: none"> <li>• UP increases the multiplier and DOWN decreases the multiplier.</li> <li>• Available multiplier values are: 1/16, 1/8, 1/4, 1/2, 3/4, 1/1, 2/1 4/1, 8/1, 16/1, 32/1 and 64/1. (64/1 not available in Echo).</li> </ul>	<ul style="list-style-type: none"> <li>• High-Pass Filter with low or high frequency sync.</li> <li>• Low-Pass Filter with low or high frequency sync.</li> </ul>
<b>Flanger</b>					<ul style="list-style-type: none"> <li>• Flanger with positive feedback.</li> <li>• Flanger with negative feedback.</li> </ul>
<b>Phaser</b>					None
<b>Echo</b>	Adjusts the amount of echo recirculation, which in turn affects how quickly the echo effect decays. The amount of recirculation varies with the echo options selected (see last column). Setting the control to minimum or “0” results in a Dry signal with the minimum recirculation setting. Setting the control to maximum or “10” results a Wet signal with maximum recirculation.	Adjusts the length of the recorded sample used by the echo. <ul style="list-style-type: none"> <li>• Holding down the <b>TAP</b> button and turning the <b>TIME</b> encoder adjusts the BPM.</li> <li>• Pressing the <b>ECHO</b> button clears the echo. Time range is 1 ms to 10920 ms.</li> </ul>	Pressing the <b>TAP</b> button and tilting the <b>BEAT</b> joystick up/right or down/left selects the BPM source. The source is shown in the mixer display after the BPM number: <ul style="list-style-type: none"> <li>(*) Manual Tap</li> <li>(S) Scratch Live</li> <li>(R) <b>USB A</b> Beat-Clock,</li> <li>(E) <b>USB B</b> Beat-Clock.</li> </ul>	Press down on the <b>BEAT</b> joystick to Lock the current BPM. This prevents the current BPM from changing until you manually change the BPM, Time, BPM Clock Source, or click the Beat Joystick Button again to unlock it. Locked BPM is indicated by “BPM” flashing in the display.  Hold down the <b>FILTER</b> button and toggle the <b>BEAT</b> joystick to scroll through the Filter types.  Hold down the <b>FLANGER</b> button and toggle the <b>BEAT</b> joystick to switch between + / - feedback.  Hold down the <b>ECHO</b> button and toggle the <b>BEAT</b> joystick to scroll through the Echo types.	<ul style="list-style-type: none"> <li>• Echo: No feedback filter. Recirculation is adjustable 0-70%.</li> <li>• Hold Echo: No feedback filter. Recirculation is adjustable 0-100%.</li> <li>• Low-Cut Echo: Feedback filter adjustable from 20 Hz to 10 kHz. Recirculation is adjustable 0-70%.</li> <li>• Low-Cut Hold Echo: Feedback filter adjustable from 20 Hz to 10 kHz. Recirculation is adjustable 0-100%.</li> </ul>
When either Hold Echo option is selected, it is possible to suspend an echo. To engage suspend, press the <b>TIME</b> encoder. The <b>ECHO</b> button flashes, indicating that suspend is active. Suspend terminates input to the delay memory while continuing to play delay memory indefinitely. Press the <b>TIME</b> encoder again to terminate suspend. If you want a suspended echo to gradually decay, turn the <b>DEPTH</b> knob CCW. If you want the decay to stop, turn the <b>DEPTH</b> knob back to or above where it was at when suspend was engaged.					
<b>Robot</b>	Adjusts the Wet/Dry mix and warble of the robot.	Adjusts the % of pitch shift. <ul style="list-style-type: none"> <li>• % of pitch shift is shown by the bar in the display.</li> <li>• Pressing the <b>TIME</b> encoder resets pitch shift to 0%.</li> </ul>	Does not affect the robot.	Adjusts the pitch up/right or down/left in 20% steps.	None
<b>Reverb</b>	Adjusts reverb intensity.	Adjusts reverb decay time. <ul style="list-style-type: none"> <li>• % of decay time is shown by the bar in the display.</li> </ul>	Does not affect reverb.	Adjusts the decay time up/right or down/left in 10% steps.	<i>*Effect options available in the Scratch Live, ASIO and Core Audio hardware control panels.</i>

# Core Audio and ASIO Drivers

The Scratch Live installer includes drivers that allow you to use your Rane Sixty-Two with other audio applications. The Core Audio (Mac) and ASIO (PC) drivers can be installed when you install Scratch Live. See the instructions in “Installing Scratch Live” on page 12.

Once installed, you will have the option to use the Sixty-Two with 3rd party DAWs using ASIO or Core Audio interfaces. NOTE: These drivers only work with audio applications that are compatible with these audio standards.

## ASIO (Windows)

The Sixty-Two comes with a low-latency ASIO device driver to interface with software applications other than Scratch Live on Windows operating systems. Multi-client ASIO allows different audio software applications to simultaneously stream audio to and from the Sixty-Two. If the same playback channel is selected in more than one application, the driver mixes the audio from the applications before streaming it to the device.

The driver Control Panel may be launched from the Windows Control Panel. Select Start > Control Panel > Rane Sixty-Two.

## Core Audio (Macintosh)

The Sixty-Two uses a low-latency Core Audio device driver to interface with software applications other than Scratch Live on Macintosh operating systems. Core Audio allows different audio software applications to simultaneously stream

audio to and from the Sixty-Two.

To launch the Sixty-Two driver Control Panel, open the System Preferences window. Locate the Sixty-Two in the “Other” section and click the Sixty-Two icon.

## Driver Control Panel

The control Panel consists of four pages: Preferences, Program Inputs 1-2, Effects and MIDI. To move between the four pages, click the  icon in the upper left-hand corner of the control panel.

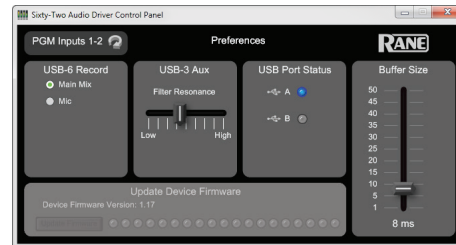

### Preferences page controls:

- **USB-6 (11-12) Record source:** Two radio buttons select the Main Mix or Mic.
- **USB-3 (5-6) Filter Resonance:** Slider adjusts the resonance from Low to High for the  AUX Filter.
- **USB Port Status:** Indicates active USB port(s).
- **Buffer Size:** The Buffer Size control allows the USB driver buffer to be increased or decreased. The Sixty-Two drivers are designed to run at latencies as low 8 milliseconds. However, computer performance and available resources (number of applications running) may adversely affect the computer’s ability to stream audio reliably. If pops and clicks are heard in the USB audio, try increasing the buffer size to eliminate them. With ASIO, total round-trip latency is equal to Buffer Size plus device latency. With Core Audio, total round-trip latency is equal to Buffer Size plus software application buffer latency, plus device latency. Device latency is 2.26 ms.
- **Update Device Firmware:** This panel indicates the firmware version currently installed in the Sixty-Two. If the Sixty-Two firmware installed on your computer is newer than the firmware in your

Sixty-Two, the Update Device Firmware panel is enabled. Pressing the Update Firmware button updates the Sixty-Two firmware to the newer version.

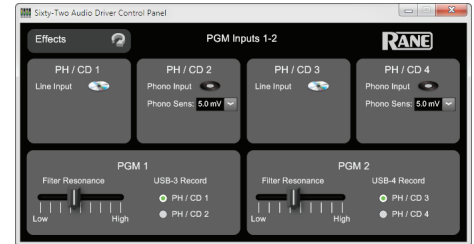

### PGM Inputs 1-2 Page Controls:

There is one panel for each channel strip on the mixer. Each PGM panel controls these functions:

- **Analog Input Source:** The analog input for each channel may be set for Line level (CD) or Phono level (PH) using a switch on the rear of the mixer. PH/CD 1 and PH/CD 2 are associated with PGM 1. PH/CD 3 and PH/CD 4 are associated with PGM 2. The control panel shows the input mode selected on the mixer for each of the four inputs. The mode can only be changed on the mixer.
- **Phono Sensitivity:** If Phono Input is selected on the mixer, the Phono Sensitivity adjustment appears in the panel. Click the down-arrow to display a list of 16 sensitivity settings between 2.5 mV and 10 mV in 0.5 mV steps. The default is 5 mV. Set the Phono Sensitivity to the same level of your cartridge (see your cartridge documentation for the correct value). Another method is to match the level of a CD on another input.
- **Filter Resonance:** Each channel of the Sixty-Two has a Filter knob that provides High- and Low-Pass filtering. Filter resonance controls the “peak” of the filter cutoff frequency. The Low setting provides the smoothest Filter without adding gain. The High setting adds accent to frequencies near the Filter cutoff point by adding about 12 dB of gain. Adding gain in a narrow region around the cutoff frequency adds a “zip” effect to audio as the Filter is swept. The default is 5 dB.

- **USB-3 (5-6) Record Source:** This control allows users to select one of two analog sources as the vinyl emulation or USB record source for PGM 1. The two radio buttons allow the user to select PH/CD 1 or PH/CD 2. The post PGM 1 fader signal is always available for recording on USB 1 (1-2) record.
- **USB-4 (7-8) Record Source:** This control allows selecting one of two analog sources as the vinyl emulation or the USB record source for PGM 2. The two radio buttons allow the user to select PH/CD 3 or PH/CD 4. The post PGM 2 fader signal is always available for recording on USB 2 (3-4) record.

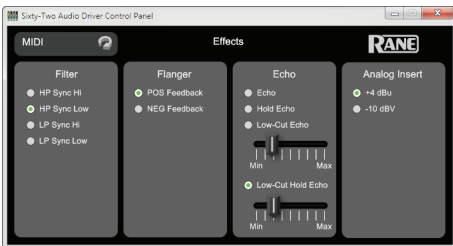

**Effects Page Controls:**

**The Filter panel** has four radio buttons allowing users to select filter type and sync mode:

- High-Pass Filter with high-frequency sync.
- High-Pass Filter with low-frequency sync.
- Low-Pass Filter with high-frequency sync.
- Low-Pass Filter with low-frequency sync.

**The Flanger panel** has two radio buttons allowing users to select one of two feedback modes:

- Positive feedback.
- Negative feedback.

**The Echo panel** allows users to select one of four echo modes:

- Echo with no feedback filter and adjustable recirculation 0 to 70%.
- Hold Echo with no feedback filter and adjustable recirculation of 0% to 100%.
- Low-Cut Echo with adjustable feedback filter and adjustable recirculation 0 to 70%.

- Low-Cut Hold Echo with adjustable feedback filter and adjustable recirculation of 0% to 100%.
    - The sliders in the control panel set the low-cut filter cut off frequency.
- Echo Default Effects settings are:
- Low-Pass Filter with high-frequency sync.
  - Flanger with positive feedback.
  - Echo with no feedback filter.
  - Echo filter frequencies default to 82 Hz.

**The Analog Insert panel** has two options:

- +4 dBu
- -10 dBV

We recommend the +4 dBu setting unless you insert a low-voltage device, in which you should use the -10 dBV setting.

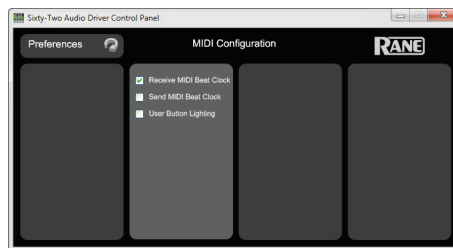

**MIDI Configuration Page:**

- When **Receive MIDI Beat Clock** is checked, the mixer receives MIDI Real Time System Messages.
- When **Send MIDI Beat Clock** is checked, the mixer sends MIDI Real Time System Messages.
- When **User Button Lighting** is checked, the mixer will not automatically light button LEDs for momentary presses. Enable this option if you wish to send MIDI commands to the mixer from third-party software to control button LEDs.

**Factory Defaults**

To reset the Sixty-Two Mixer's:

- Record/Control Sources
  - LP/HP Filter Resonances
  - Filter Type, Flanger and Echo effects
- to factory default settings:

1. Power off the Sixty-Two.
2. Push both PGM 1 and 2 **FLEXFX** buttons at the same time.
4. While holding these buttons down, power on the Sixty-Two.
5. Immediately after fading up, the **FLEXFX** lights flash one time, indicating a successful reset.

**NOTE: Settings are saved in the mixer. Software is updated with the mixer's settings. Therefore, the mixer may replace control source and effect settings in Scratch Live or software control panels with current mixer settings that may have been changed by a different laptop.**

# Scratch Live: Getting Started

## System Overview

The Scratch Live control records and CDs are pressed with an audible tone specifically developed for controlling the Scratch Live software application.

The Sixty-Two converts the control signal coming from each deck into digital audio, to be sent via USB to the Scratch Live software, which decodes that signal into a stream of information based on what the DJ is doing with the control disc. A virtual 'deck' replicates the movements of the control disc. Audio files loaded onto the Virtual Decks are then played back through the outputs of the Sixty-Two, with any manipulation of the control discs reproduced on the audio, effectively emulating vinyl control of the files loaded in software.

## Connecting the Sixty-Two

Follow these steps to set up the Sixty-Two for Scratch Live, using up to two turntables or CD players to control the software playback.

### 1. Inputs

Connect your CD players or turntables to the **ANALOG INPUTS** on the Sixty-Two. Connect the deck left of the mixer to 1 or 2, and the deck on the right to 3 or 4.

Match the L channel from each of your decks (usually white) with the white (uppermost) RCA sockets on the mixer and R (usually red) with the red sockets. This is important to give Scratch Live the correct direction of playback. If your songs play backwards, you probably have

the left and right channels swapped from your deck.

### 2. Input Level Selection

Set each input to the correct input level using the **PH - CD** switches. **PH** = Phono and **CD** = Line (for CD players). Unused inputs are best set to **CD**.

### 3. USB Audio

Select Scratch Live as the audio source for a channel by turning a PGM SOURCE knob to a  USB input. Any of the four analogue inputs may be used for Scratch Live vinyl emulation control. Control input sources for both PGM 1 and PGM 2 are selected in the Scratch Live setup screen.

### 4. Connect the Sixty-Two to your computer

Using the provided USB cable, connect either USB A or USB B to an available USB 2.0 port on your computer. Make sure you connect it directly to your computer and not through a hub or splitter.

## Turntable Setup

1. Set the tone arms to the specific recommendations of the cartridge used, so that the needle never leaves the record, but not heavy enough that it heats up significantly. Both produce poor tracking.
2. Grounding is extremely important when using Scratch Live. Make sure you have good connections from the ground wires of your turntables to a grounding post on the Sixty-Two. If you do not ground your turntables properly, the control signal will be noisy and the tracking of the record position will be erratic.

## CD Player Setup

Disable all built-in effects on the CD player, including keylock/master tempo.

# Installing Scratch Live

Check for the latest download version of Scratch Live software at [serato.com](http://serato.com). If it is newer than the version on your CD-ROM, we recommend installing it instead.

## Mac

1. Insert the Software Installation CD-ROM and double-click the Scratch Live Installer.mpkg icon.  
or  
Launch the installer you just downloaded from [serato.com](http://serato.com).
2. Follow the on-screen instructions. Once the installation is complete, Scratch Live will appear in your applications list. You may like to drag the Scratch Live icon to your dock for quick launching.
3. Plug in your Sixty-Two. No extra installation is required to use Scratch Live.



4. The optional Rane Device Drivers are required for other software you may have that uses Core Audio to communicate with your Rane device. To install the Core Audio drivers, double-click the .pkg file inside the appropriate product folder in the Rane Device Drivers folder on the software installation CD. Core Audio driver updates are available to download from the product's page at [dj.rane.com](http://dj.rane.com).

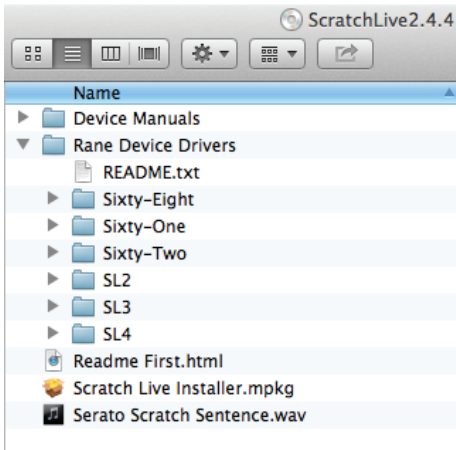

## Windows

It is important that Windows users install the Sixty-Two drivers as well as the Scratch Live software. The easiest way to do this is to allow the Scratch Live installer to do all the work.

**1. Connect your Sixty-Two before you insert your installation CD.** When you first connect it, Windows will attempt to install the drivers via the hardware wizard. Cancel and close the hardware wizard.

**2. Insert the Software Installation CD-ROM.** Make sure your Sixty-One is connected first. If a window doesn't open automatically, browse to the CD drive. Run setup.exe.

or  
Launch the installer you just downloaded from serato.com.

**3. Follow the on-screen instructions.** Once the installation is complete, Scratch Live appears in the Start Menu under All Programs > Serato > Scratch Live.

Because the Sixty-Two was connected prior to installing Scratch Live, no extra hardware installation is required.

## Additional Windows ASIO Drivers

Once Scratch Live is installed, any additional hardware that is connected will be recognized and the drivers will be automatically installed.

## Starting the Software

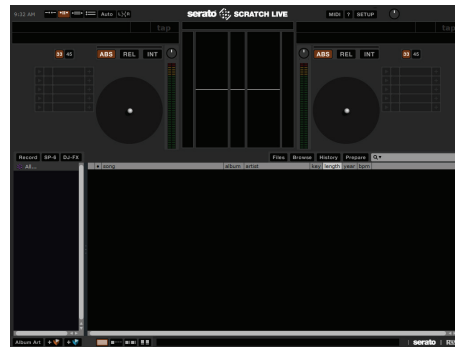

Close all other programs on your Mac or PC.

When you load Scratch Live for the first time, you will see the screen shown above.

## Installing More Than One Version

Installing a new version will by default overwrite any previous version you had installed, however it is easy to have more than one version of Scratch Live installed if you wish.

**Mac users:** before installing, find the Scratch Live application (by default it is in the Applications folder), and rename it - for example Scratch Live 2.0.0. When you install the new version, the old application will not be overwritten, and you can choose which version you want to run by going into the folder and double clicking on the application. You can also do this if you have already installed the latest version - just rename the application (eg. to Scratch Live 2.1.1), and then reinstall the earlier version.

**Windows Users:** before installing, find the Scratch Live executable (by default it is in C:\Program files\Serato\ScratchLIVE), and rename it - for example Scratch Live 2.0.0.exe. When you install the new version, the old executable will not be overwritten, and you can choose which version you want to run by going into the folder and double-clicking the executable. You can also do this if you have already installed the latest version — just rename the executable (eg. to Scratch Live 2.1.1.exe), and then reinstall the earlier version.

## Firmware Check

On occasion new firmware updates are included within Scratch Live software updates. After updating, run Scratch Live and click the Hardware tab in the Setup screen to see if new firmware is installable. **See “Updating Firmware” on page 42.**

If you're using the TTM 57SL and/or Sixty-Two mixers at various clubs, you may come across one that has a newer version of firmware installed. With the newer firmware, the mixer will still be usable with older Scratch Live versions, but certain features may not work as expected. To avoid this situation, make sure you always have the latest version of Scratch Live installed.

## Using the Tool Tips



Click on the ? icon to enable tool tips. Tool tips provide a handy way to learn the various features of Scratch Live. Move the mouse over a section of the screen to bring up a context-sensitive tool tip. Holding the mouse over the ? button with tool tips turned on will show you a list of all keyboard shortcuts. Tool tips are available in several languages. Scratch Live will display the tool tips in the language that your computer is set to. If your language is not available, the tool tips will be displayed in English.

# Calibrating Scratch Live

Since Scratch Live is controlled by an analog signal, there is no guarantee of what state that signal will be in by the time the software gets to interpret it. Therefore, Scratch Live needs to be able to handle a wide range of signals, and be configurable to use them optimally. Calibrating is just configuring the software to your situation. **Calibration is equally important for both vinyl and CD users of Scratch Live.**

There are two parts to the Scratch Live control signal: The directional tone, and the noise map. Listening to the control vinyl, the directional tone is the 1 kHz tone. The noise map sounds like random noise over the top of the tone.

The directional tone provides the current speed and direction of the record, while the noise map tells the software precisely where on the record the needle is currently.

## The Noise Threshold

A threshold is a lower limit, below which a process will not occur. In the case of Scratch Live, the noise threshold is the limit below which the input signal will not be interpreted as control signal; in other words if it's below the threshold, it is considered noise and ignored.

This setting is necessary because a stylus is very sensitive, and will inevitably pick up noise from the environment as well as the signal on the record, especially in the noisy environment of a live show.

## How to Calibrate Scratch Live

With music playing in the background (from any source), put your needle on the record with the turntable **stopped**. If you are using CD players, the same rules apply. Have the CD deck paused or stopped while calibrating. Ensure the input level in Scratch Live is set correctly to Line (CD). **See “Input Select Status” on page 42.**

Click and hold the Estimate button until the slider stops moving. Moving the threshold slider to the left will make Scratch Live more sensitive to slow record movement, but also more sensitive to background noise.

### Repeat the process for each deck.

#### Things to remember:

- Your needle must be on the record.
- Your turntable (or CD player) must be stationary.
- The background music playing must be at a similar level to which you will play your set at.
- Calibrate Scratch Live every time you play.

**TIP: If the slider jumps to the far right, then you have a problem with noise in your turntables/CD players/mixer. Check all your connections and make sure your equipment is well earthed. In some situations you will not be able to improve the signal quality, and you will have to play on regardless. In this situation, stick to REL mode.**

## The Scopes

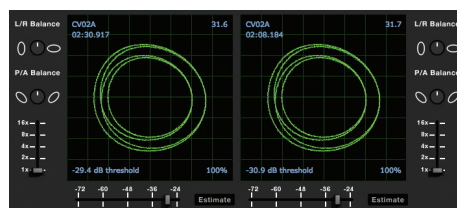

The scopes on the Setup screen in Scratch Live display the input signal as a phase diagram. The key factors to look at on the scope display are crisp clean lines, round shape, and the tracking percentage in the lower right corner.

Start both turntables or CD players. You will see green rings appear in the scope view as shown.

For optimal performance the inner ring should be as close to circular as possible. Use the scope zoom slider (**1x to 16x**) to zoom in or out as necessary. Use the scope **L/R Balance** and **P/A Balance** controls to adjust the shape of the inner ring.

The number in the top left corner of the scope view gives the current absolute position within the control record or CD. The number in the top right corner is the current speed in RPM. In the bottom left is the current threshold setting, and the number in the bottom right shows the percentage of readable signal — this number should be close to 85% when your system is calibrated properly.

## Calibration Troubleshooting

After calibration, the number in the upper right corner of the scope view should say 0.0 while the needle is on the record and the turntable is stopped.

If that number is fluctuating then manually move the Estimate slider to the right until that number is stable at 0.0. If you've moved the slider all the way to -24 and its still fluctuating then you have a grounding or interference problem somewhere in the chain.

If so, the first thing to check is that the grounding wire coming from your turntable is connected to a Sixty-Two grounding post.

Next, make sure that the Sixty-Two isn't sitting next to a power source such as a power strip and that the RCA cables aren't laying across other power-conducting cables.

If you are still experiencing issues, you might have to adjust the placement of your setup. For example, make sure bass bins aren't directly under the turntables.

If you have trouble getting the rings circular, you probably need to clean or change your needles.

If the image appears as a line, then you have a missing channel. Check your RCA connections and needles. **for more calibration troubleshooting help See “Scope Reading and Fixes” on page 48.**

# Importing and Playing Music

## Importing Your Music

The easiest way to load music into your library is by using the **Files** button:

1. Click on the Files button to open the files panel. The left side of this window displays various locations on your computer hard drive (and external drives if you have one). Click on these locations to navigate your computer and find your music. By default, your music will usually be found in either “Music” (Mac) or “My Music” (Windows).

2. Once you have located your music, drag the folder or files you want to import onto the purple “\* All...” icon. This is located to the left of your screen at the top of the crates and playlist window. If you wish to import all of your music, just drag your whole music folder onto this icon.

**TIP: You can also import by dragging files and folders directly from Windows Explorer (PC version) or Finder (Mac version) into the Scratch Live library.**

**TIP: Adjust the size of the Files window by clicking and dragging near the three dots up or down. The vertical crates window adjusts left and right.**



## Supported File Types

Scratch Live supports fixed and variable bit rate .MP3, .MP4, Ogg Vorbis, .AAC, .AIFF, .ALAC, .WAV and Whitelabel (wl.mp3) file types. M3U playlists are also supported. For more on Whitelabel.net audio files, see “Whitelabel.net” on page 20.

**NOTE: Older iTunes Music Store DRM files cannot be played back by Scratch Live. iTunes Plus files are DRM-free.**

## Playing Music

Click on the “\* All...” icon to show all the tracks in your library. Use the keyboard shortcut Shift - Left Arrow to load the highlighted track on to the Left Deck, and Shift - Right Arrow to load the highlighted track on to the Right Deck.

**TIP: You can also load tracks to Decks using the mouse. Click and drag a track from the track list area on to either Virtual Deck.**

To start playing a track, simply put the needle on the record and start the turntable. The track will start playing as soon as it detects the signal from the control vinyl (or CD).

In ABS mode, the track will play from the position dictated by the placement of the needle on the record. If you place the needle at the beginning of the record, the track will start playing from the beginning. You can skip through the track by picking up the needle and placing it further into the record, just as with regular records (this is known as needle dropping). See “Scratch Live Modes” on page 24.

## Track Display

When a track is loaded, the track name, artist and length are displayed in the track title bar, and the Virtual Deck shows a solid black line.

If the track has BPM or key information written in the tag this will also be displayed. See “Set Auto BPM” on page 20.



# Whitelabel.net

The Serato Whitelabel Delivery Network is a unique system that allows record labels to digitally deliver promotional releases directly to DJs.

To download Whitelabel audio files and sign up to receive updates on the latest promotional releases, visit [whitelabel.net](http://whitelabel.net).

## Whitelabel Audio Files

Whitelabel.net audio files are a unique format (file extension wl.mp3) developed by Serato. They are specially prepared for use in Scratch Live; pre-analyzed, tagged with song and artist info, BPM and album art where possible.

Whitelabel audio files play as high quality 320 kbps stereo audio in Scratch Live when Rane Scratch Live hardware is connected. Without Scratch Live hardware connected, or when playing these files through other mp3 software and devices, they will play as low quality 32 kbps mono audio.

Whitelabel audio files are promotional releases from records labels available to Scratch Live DJs for free from Whitelabel.net.

# Preparing Your Files

Before you play your music in Scratch Live, It is important to first analyze your files.

The analyze files function processes the songs in your library to detect file corruption, saves the waveform overview to an ID3 tag\*, and calculates auto-gain and BPM values.

## How to Analyze Files

To analyze files run Scratch Live with the Sixty-Two disconnected. On the left side of the main screen, click the **Analyze Files** button to automatically build overviews for all the tracks in your library.

**TIP: You can drag and drop individual folders, crates or files onto the Analyze Files button to force the building of overviews at any time.**

## About Corrupt Files

If Scratch Live detects a corrupt file it will tag it with a corrupt file icon:



It is very important that you delete ANY corrupt files from your library as they can cause Scratch Live to crash regardless if you play the file or not. See **“Status Icons” on page 37** and **“Corrupt File Descriptions and Diagnoses” on page 47**.

## Set Auto BPM

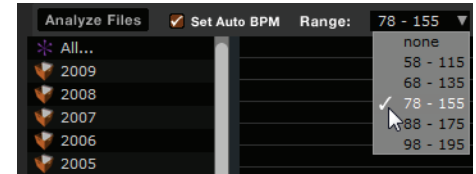

If this option is checked while analyzing files, Scratch Live will calculate the estimated tempos of your files. If Scratch Live is confident that the Auto BPM estimate for a file is accurate, it will be written to an ID3 tag\* in the file. The Auto BPM function will not be applied if the track already contains BPM information. To re-analyze these files and use Auto BPM or auto gain, drag them onto the **Analyze Files** button. If you know your file’s BPM will fall within a certain range, use the range drop down to avoid double or half value BPMs being calculated.

**\*NOTE: ID3 tags contain data about your tracks and are saved inside the files themselves. Genre, track name and artist are examples of common tag information. See “Editing ID3 tags” on page 37.**

## The Offline Player

The offline player is a useful tool for preparing crates, auditioning tracks, and setting cue and loop points. The offline player is available when Scratch Live hardware is not connected, and outputs through the current default audio device. Load a track to the offline player by dragging and dropping onto the Deck, or pressing shift+left arrow. If the end of the loaded track is reached, the next track in the current playlist is played automatically. Click the Offline Player Controls button (outlined below) to expand and hide the offline player controls.

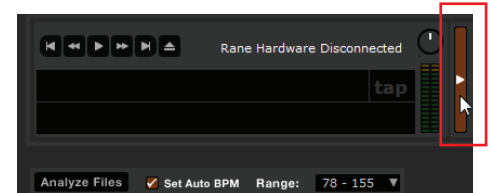

For information on rescanning, moving, copying, deleting and backing up your files, see **“File Management” on page 38**.

# Playback Control

## The Control CD

The control CD has two tracks. The first track is 15 minutes long and controls playback. The second track is 40 seconds long and controls vinyl scroll.



# Main Screen Overview

## The Control Record

The control record has two sides. The first side is 10 minutes long and contains the Vinyl Scroll section. The second side is 15 minutes long. Scratch Live can be configured to work with records playing at either 33 RPM or 45 RPM, depending on your preference. The record has thin marks every minute, and a thicker mark every 5 minutes (when playing at 33 RPM). These marks are to assist you when using needle dropping to move through the track. These marks do not affect the playback of the track.

The mode will switch when it reaches the end of the record so your track won't stop. See **"Absolute Mode"** on page 25.



## Vinyl Scroll

Vinyl Scroll allows you to select and load tracks using only your turntables (or CD player) – no contact with the computer necessary! To use Vinyl Scroll with turntables, lift the needle off the record and drop it into special "bonus track" section at the end of the record's A side. The movement of the control disk now controls the selected track within your library. Lift the needle out of the Vinyl Scroll section of the record and into the lead out (between the Vinyl Scroll area and the end of the record) to change crates or iTunes playlists. Go back to the Vinyl Scroll area of the record to choose a track within the crate or playlist. Once you have found the track you wish to play, put the needle back at the beginning of the record and it will load automatically.

This feature is available to CD users. Go to track 2 on the control CD to access Vinyl Scroll. Find the track you want to load, and go back to track 1. The track you selected will be loaded and ready to play. You can reverse the direction of Vinyl Scroll and set the sensitivity in the Setup screen.

**TIP: You can also use Vinyl Scroll in the Prepare window. See the options for "Vinyl Control" on page 44.**

## Virtual Deck

The Virtual Deck shows everything about the speed and position of a track. As the vinyl rotates, so does the line on the label. The circular progress bar around the edge is a visual representation of the position within the song, and can be set to flash to warn you that the track is nearing its end. The time and remaining time are displayed in minutes and seconds. The pitched BPM (BPM with pitch adjustment multiplier added) is shown on the left of the Virtual Deck, and the turntable speed as a percentage pitch shift is shown on the right of the Virtual Deck. If the track has no BPM information, pitched BPM will not be shown.

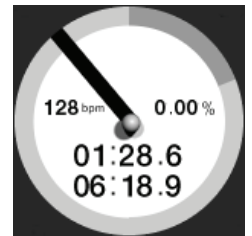

If you are playing regular vinyl, notice the Virtual Deck behaving strangely as Scratch Live attempts to decode the incoming signal. This will not cause any problems, but you may find it distracting. You can unload the currently loaded track using the Virtual Deck eject button.

**TIP: Use the keyboard shortcut shift-alt-arrow to unload a track from the Virtual Deck.**

**Visual Aids**

When the track is playing several waveforms are displayed. Each shows a different aspect of the track being played.

**Tempo Matching Display**



The Tempo Matching display area provides a helpful tool for beat matching. Scratch Live detects the beats within the track, and places a row of orange peaks (for the track on the left side) above a row of blue peaks (for the track on the right side) in the Tempo Matching display area. When the two tracks are matched to the same tempo, the peaks will line up. The tempo display is aligned with the beginning of the bar, so the peaks keep their relative position as the track plays. This display does not show the relative timing of the beats, only the tempos of the tracks. The peaks will still line up when the tracks are playing at the same tempo, but are out of sync.

**Track Overview Display**

This view provides a complete overview of the track waveform, and includes a marker to show the current position within the track. This view is useful for finding transitions within the track. The waveform is colored according to the sound spectrum – red representing low frequency bass sounds, green representing mid frequency sounds and blue representing high frequency treble sounds.



You can jump to different positions within the track by clicking on the Track Overview display (disabled in ABS Mode). Grey lines behind the overview show the length of the track – a thin grey line every minute, and a thick grey line every 5 minutes. The overview will be filled when you load the track onto a Virtual Deck. On slower computers, you should disable **Autofill overviews** in the Library tab of the Setup screen. See **“Preparing Your Files”** on page 20 and **“AutoFill Overviews”** on page 45.

**Main Waveform Display**

This view provides a close-up of the track, including color coding to show the frequency of the sound; red representing low frequency bass, green representing mid-frequencies and blue representing high-frequency treble sounds. You can also switch to a three-band spectrum view by holding the ctrl key and clicking on the waveform. Click on the waveform to ‘scrub’ or make fine adjustments to your position within the track. This applies to INT Mode only, and may be useful if you wish to set cue points in your tracks without your turntables or CD players connected. The Main Waveform is zoomed around the current position in the track. See **“Cue Points”** on page 26 and **“Scratch Live Modes”** on page 24.

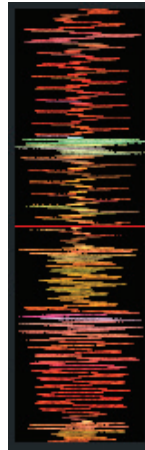

**TIP: Use the + and – keys to zoom in and out.**

**TIP: Waveform can be either vertical or horizontal. See “Display Modes” on page 24.**

**Kick Drum**

In this example, the red part of the wave represents a kick drum, while the purple part represents a snare drum.

**Snare Drum**



**Beat Matching Display**

This view shows the position of beats within the track. When beat matching, this view helps align the downbeats of the two tracks. The markers are matched up when the two tracks are beat matched.



**Example:** The following is a demonstration of using the visual aids to help beat match. In this example, the track that is playing is on the Left Deck, and the track to be mixed in is on the Right Deck.

1. Start the track playing on the Right Deck. After a few seconds, blue peaks appear in the Tempo Matching display.
2. Adjust the pitch of the right turntable until the blue peaks sit under the orange peaks in the Tempo Matching display. Once they are aligned, the two tracks have the same tempo.
3. Next align the markers in the Beat Matching display. Watch the color of the items passing by in the Main Waveform display. Remember that a kick or bass drum will be red in color, and a snare drum will be green or blue. This technique will by no means guarantee perfect mixes, but may help to speed up the process of beat matching.

**Master Gain**

The master output of Scratch Live can be controlled using the master gain control. This adjusts the volume of all tracks played. Ctrl-click the knob to reset it to 12 o’clock.



**NOTE: For best results, set the master gain to 12 o’clock, and adjust the volume of individual tracks using the track gain adjustment.**

**33 / 45 Speeds**

Set this to match the speed of your turntable for normal playback.



## Tracking Indicator

The tracking indicators on the main screen show the quality of the signal coming from the control record or CD. The length of the bar indicates the speed of the record or CD. The color indicates the amount of position information Scratch Live is receiving. When you are playing the record at normal speed, the tracking indicator should be grey. If it is mostly red there is a problem reading the control signal. Make sure your needles are clean, and check the calibration in the setup screen.

**NOTE: It is normal for the tracking indicator to be red when cueing or scratching.**

## Tap Tempo

For tracks with no BPM information, there is a tap tempo button displayed where the BPM usually is, in the song info area. Pressing alt-space bar activates the tempo tapper (press alt-space bar a second time to activate the tempo tapper on the Right Virtual Deck). Tap the space bar along with the beat. After you've tapped the first beat, you can switch to double time tapping, half time, start of each bar etc. The range is set by the first two taps, after that you can switch to any steady rhythm you feel comfortable with – quarter notes, half note, whole notes. Esc resets the BPM, Enter saves the BPM to the track. You can use the mouse if you prefer. Your CD player or turntable's pitch slider doesn't need to be at zero, we do the math for you. You can also use the tempo tapper when no song is loaded, for finding the BPM of regular records, for example.

## Eject

This ejects the track playing or loaded from it's Virtual Deck.

## Key Lock

When Key Lock is on, the key or pitch of the song stays locked at what it would be if the track was playing at normal speed, regardless of the platter speed of the turntable or CD player. Key Lock has scratch detection, so that it automatically turns off when scratching for a natural scratching sound. Turn Key Lock on or off by clicking the button to the top right of the Virtual Deck.

**TIP: F5 and F10 will turn Key Lock on and off for the Left and Right Decks respectively.**

## Repeat

Use the Repeat function to repeat the song across the entire length of the control record.

**TIP: Short "loop" samples can be turned into a continuous track using the Repeat function. The loops must be less than 10 seconds long, and cut at the start and end of a bar.**

## Censor

Use the censor button to 'mask' parts of a song, or use as a special effect. When you press the censor button, the track starts playing backwards from that point. When you release the censor button, the track plays forward from the point you would have been, had you not pressed the censor button. Censor is available only in REL and INT Modes.

## Autoplay

Click the **Auto** button to enable autoplay. With this setting turned on, when one track finishes playing, the next track starts automatically. Load from a crate to play through the songs in that crate, or from your library to play through your library. Autoplay works in both REL and INT modes. **Play from start** must be checked in the Playback tab of the Setup screen for autoplay to work correctly. **See "Play From Start" on page 43.**

## Track Gain

Use the track gain knob to balance the volume of the tracks in your library. Any adjustment made to the gain of a track is saved with the file, and will be reapplied to the entire track when it is loaded again. The level meter shows the level sent to the hardware interface after both individual track gain and master gain adjustment. Ctrl-click the knob to reset it to 12 o'clock.

**NOTE: For automatic gain setting of your tracks, see "Use Auto Gain" on page 43.**

## USB Dropout Indicator

The USB dropout indicator on the main screen is a useful trouble shooting tool if you have problems with audio dropouts. Such dropouts are caused by an interruption in passing the audio to the Scratch Live hardware interface. If such an interruption (or dropout) occurs, a red light will appear briefly, just to the left of the Scratch Live logo at the top of the screen. The light will be red for one second, and then orange for four seconds.

### If you experience USB drop outs:

- Increase the USB Buffer Size **See "USB Buffer Size (Latency)" on page 42.**
- Try closing other applications that are running at the same time as Scratch Live.
- Try turning off background tasks, for example, wireless networking.
- If your CPU load is very high, try decreasing the Maximum Screen Updates setting in the Display tab of the Setup screen. **See "Maximum Screen Updates" on page 45.**

## Display Modes

Scratch Live gives you the option of four different display modes to suit your style of performance. The Display Mode buttons are located in the top left of the Main Screen. They are:

**Library Mode:** Maximizes your library space by minimizing the Virtual Deck information displayed. In Library Mode only the track information, Virtual Deck, mode, track overview display and meter are displayed.



**TIP: Use the space bar to toggle between Library Mode and your current display mode.**

**Classic Vertical Mode:** Two Decks are displayed on the left and right sides of the screen with vertical waveforms in the middle.



**Classic Horizontal Mode:** Two Decks are displayed on the left and right sides of the screen with horizontal waveforms in the middle.



**2-Deck Stack Mode:** Two Decks are stacked on top of each other in a horizontal fashion. Stack Mode aligns the waveforms on top of each other, while maximizing waveform space. The controls for all Decks can be shown or hidden by pressing the Show Deck Controls Button on any Deck.



## Library Views

You can choose between four different library views which allow for visual browsing using text and album art. Select your Library View by using the buttons in the bottom left area of the main screen. The available Library Views are:

**Simple List:** Displays the track information in a text list.



**Album Art List:** Adds an album art column to the Simple List mode.



**Album Art Grid 1:** Displays the album art as a grid with the track information text to the right.



**Album Art Grid 2:** Displays the album art as a grid with the track information text below.



**NOTE: Your files must have album art added for it to be displayed. See “Adding Album Art” on page 37.**

**TIP: For all views you can adjust the font size by using the Font Size slider in the Library tab on the Setup screen. For all Album Art views you can adjust the album art size using the Album Art Size slider in the same area.**

## Scratch Live Modes

Scratch Live has three different modes of operation. You can switch between these modes by clicking the mode buttons near each Virtual Deck.



## Absolute Mode

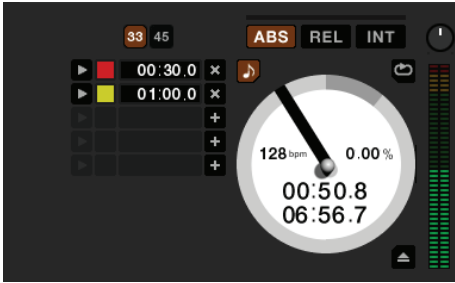

**ABS** mode is the default mode, and most closely resembles the properties of normal vinyl. The beginning of the track is mapped to the start of the record, and by picking up the tone arm and moving the needle to another part of the record (needle dropping) you can move to a different position within the track.

ABS mode faithfully reproduces the movement of vinyl control records, including stops, starts, scratching, needle dropping, rubbing and other turntablist techniques.

When you reach the end of the record using either REL or ABS modes, Scratch Live automatically switches to INT mode. This is known as Emergency Internal mode, and prevents long tracks from stopping when you run out of record. You can switch from Emergency Internal mode to ABS mode by lifting the needle and placing it in the lead-in of the control record. Emergency Internal mode will activate after 1 second. Use the keyboard shortcut F1 (left deck) or F6 (right deck) to switch to ABS mode.

**NOTE: Be careful when scratching near the end of the record not to accidentally go past this point and into internal mode, or the track will no longer respond to record movement!**

## Relative Mode

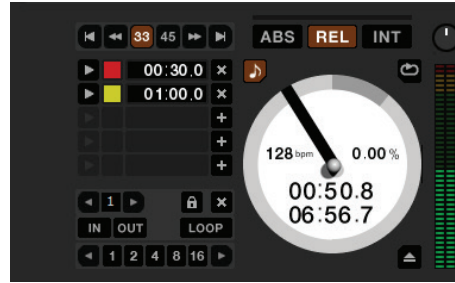



**REL** mode observes the relative forward and backward movement of the record, but does not take into account the position within the record. REL mode disables needle dropping, but allows skip-free scratching.

**See: “Drop To Absolute Position” on page 44.**

**REL** mode adds additional speed controls:

**Previous track** – Go to the previous track in the list. 

**Rewind** - The rewind function speeds up the longer you press the button. 

**Fast forward** – The fast forward function speeds up the longer you hold the button. 

**Next track** – Jump to the next track in the list. 

**TIP: Use the keyboard shortcut F2 (left deck) or F7 (right deck) to switch to REL mode.**

## Internal Mode

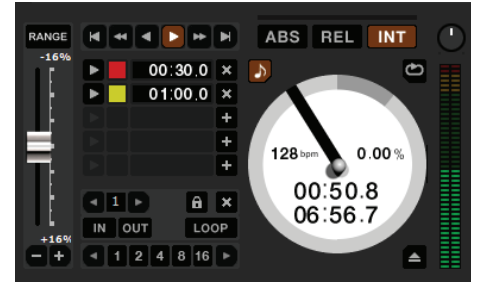



**INT** mode allows playing tracks without external vinyl (or CD) control. INT mode has a start / stop function and a virtual pitch slider. Holding down the shift key moves the pitch slider slowly. Holding the ctrl key and clicking on the pitch slider resets the pitch to zero.

Scratch Live automatically switches to INT mode when the end of the control record is reached; you can switch back to REL mode by placing the needle in the first five minutes of the control record. If you switch from ABS or REL into INT mode, Scratch Live automatically adjusts pitch to maintain playback speed as set by the turntable. Use the keyboard shortcut F3 (left deck) or F8 (right deck) to switch to INT mode.

**INT** mode adds these additional controls:

**Play / pause reverse** - Press to play, press again to stop playback.  You can adjust the braking knob in the setup screen to range from an immediate stop to a slow turntable-style ‘power down’. **See “Braking” on page 43.**

**Play / pause forward** - Press to play, press again to stop playback.  Uses the same braking as described above.

**Bend down** - Create a temporary decrease in the playback speed.  Use bend down if the two tracks are in time, but this track is slightly ahead of the other track.

**Bend up** - Create a temporary increase in the playback speed. Use bend up if the two tracks are in time, but this track is slightly behind the other track. 

**Pitch Slider** - Use the pitch slider to make pitch adjustments while using INT mode. Drag the pitch slider with the mouse to make large pitch movements, or hold the shift key and drag the pitch slider to make fine adjustments.



Clicking the **RANGE** button above the slider changes the slider range to  $\pm 8\%$ ,  $\pm 10\%$ ,  $\pm 16\%$ ,  $\pm 50\%$  or  $\pm 100\%$ .

**Temporary Cue**

There is a temporary cue point that can be used like the cue button on many DJ CD players. Press ctrl-I to set this temporary cue point on the Left Deck, and ctrl-K to set it on the Right Deck. This temp cue point is shown in the main waveform as a white marker. This cue point is not saved with the track, and by default is set to the beginning of the track. Press I to jump to this temporary cue point on the Left Deck, and K for the Right Deck. If you hold down the I or K key while the track is stopped, it will play from the temporary cue point. As soon as you release the key, it will jump back to the temporary cue point. Note that you can use this shortcut to jump to the beginning of the track if the temporary cue point has not been set. **See “Cue Points” on page 26.**

**More Controls**

You can also control playback using the computer keyboard shortcuts — turn Caps Lock on to enable. **See “Playback Keys Use Shift” on page 43.**

Left Deck	Function	Right Deck
Q	play / pause reverse	A
W	play / pause forward	S
E	pitch down	D
R	pitch up	F
T	bend down	G
Y	bend up	H
Alt-Q	load previous track	Alt-A
Alt-W	load next track	Alt-S
Alt-E	rewind	Alt-D
Alt-R	fast forward	Alt-F
Ctrl-I	set a temporary cue point	Ctrl-K

Click on the waveform to ‘scrub’ or make fine adjustments to your position within the track. This may be useful if you wish to set cue points in your tracks, and don’t have your turntables or CD players connected.

**NOTE: If you play a track in INT mode, and then switch to ABS or REL mode, the pitch adjustment will be dictated by the turntable, so there will be a jump in pitch unless they are already perfectly matched.**

**TIP: If you are in ABS or REL mode and you get a build up of dust on the needle that is breaking up the audio, hold down ctrl and press the INT button. This will take you to INT mode and reset the pitch to zero.**

**Cue Points**

Use cue points in Scratch Live to mark and trigger different parts of your tracks. The cue point markers are saved with the file in the track’s ID3 tag. This means they will be present each time you load the track.

**Setting Cue Points**

You can set up to five cue points for each track. Click on the + button to place a cue point, or use the keyboard shortcuts below. A cue point will be set at the current playhead position of the track and can occupy any of the 5 slots.

Use the keyboard shortcuts: ctrl-comma (for left) and ctrl-period (for right) to place cue points in chronological order. Alternatively, use ctrl-1 through 0 to set a specific cue point, i.e., to set a cue point on the Left Deck in slot 2, press ctrl-2.

Notice the stripe on the Virtual Deck jumps to the 12 o’clock position and changes color when you set a cue point – you are at the cue point when the stripe is one solid color and at the 12 o’clock position. As the track plays on beyond the position of the cue point, the colored bar shortens by a fifth for each rotation. Likewise, as you approach the cue point, the color will grow by a fifth each rotation. For example, the picture below shows the track just before the end of the 5th rotation before the cue point.



**TIP: Zoom in on the waveform using the – and + keys and ‘scrub’ to the desired position for greater accuracy when setting cue points.**

## Enable Hot Cues

To turn on hot cues, check **Enable Hot Cues** in the Playback tab on the Setup screen. When Hot Cues are enabled, you can set cue points simply by pressing the number keys 1 through 0 (no ctrl modifier required). Note that you can only add cues this way if the cue point slots are empty. See “Enable Hot Cues” on page 43.

## Triggering Cue Points

Click the ► arrow to the left of each cue point to jump to it (REL and INT modes only). You can also jump to cue points using shortcuts: 1 through 5 for the cue points on the Left Deck, and 6 through 0 for the Right Deck cue points.

## Editing Cue Points

To remove a cue point, use the x button on the right side of the cue point panel. You can also overwrite cue points by using the shortcut keys ctrl-1 through 0.

## Customizing Cue Points

To change the color of a cue point, click on the colored square and choose a new color from the drop down menu.

To name your cue point, double click on the “time” field. You can now edit and name this cue point to whatever you like.

You can also drag and drop cue points to change their order in the list. If you wish to have the cue points sorted by time, check **Sort cues chronologically** in the Playback tab on the Setup screen. If you load the same track onto both Decks, you will be able to add or modify cue points from either Deck.

When you jump to a cue point in INT mode while paused, the track will play from the cue point for as long as the key or mouse button is pressed, after which the playhead returns to the cue point. If this is done using the keyboard while the track is playing in either INT or REL mode, the cue point will be repeatedly triggered, producing a stuttering effect.

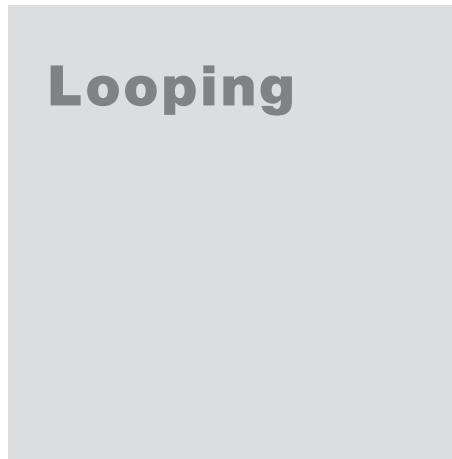

You can save up to 9 loops per track.



These loops are saved in the file, and will be present when you reload the track. To make a loop, set the in-point by clicking the **IN** button, and the out-point by clicking the **OUT** button. To turn the loop on or off, click the **LOOP** button. If you want the playhead to jump to the start of the loop when you enable the loop, hold the control key and press the **LOOP** button.

To adjust the in-point of the loop, click the **IN** button. You can use the arrow keys: left arrow to move the in-point towards the start of the track, right arrow to move the in-point towards the end of the track. Hold down the shift key while pressing the arrow key to make coarse adjustments. Click the **IN** button again to save the in-point. The same applies to adjusting the out-point.

You can also use the control vinyl (or CD) to adjust the in- and out-point. Click the **IN** button, then move the control vinyl. Moving the vinyl will adjust the in-point. Once you are happy with the new in-point, click the **IN** button again to save, and release the control vinyl.

The control vinyl will go back to controlling playback once the record is back up to normal speed. Using the control vinyl to adjust loop end points is optional — to turn this feature off, disable **Adjust loops with vinyl** under the Vinyl Control tab in the Setup screen.

There are 9 available loop slots per track. If a loop is set in a given slot, the background (behind the loop number)

will be green. Press the x button to clear the loop. If you click on the locked loop symbol, a red border will appear. This indicates the loop is locked, and you will not be able to adjust the end points or delete the loop until you unlock it, by clicking on the number again.

**NOTE: Looping applies to REL and INT modes.**

## Auto-Looping

Auto-looping allows you to create loops instantly. If the track has



a BPM value simply click the number of beats you wish to loop and Scratch Live will create the loop for you. The loop is snapped to the beats in the song detected by Scratch Live so even if you press the button slightly out of time Scratch Live will still create a perfect loop for you.

Five auto-loop buttons are available on screen at any one time. They range from 1/32 to 32 beats. The user can select the auto-loop range with the ◀ and ▶ buttons.

Pressing an auto-loop button will create a loop start point from the nearest beat to the playhead (within reason), and set a loop endpoint in the future. Pressing auto-loop 1 while auto-loop 1 is active will deactivate the loop. Pressing a different auto-loop button while looping is active will extend the endpoint of the current loop to the appropriate new auto-loop length.

You can also save an auto-loop to the next available slot. When using an auto-loop, a  save button is visible where the lock loop button normally is.

**NOTE: Auto-looping requires the track BPM to be set. See “Set Auto BPM” on page 20.**

## The A-Slot

A special loop slot ‘A’ exists for auto-looping. The act of using the auto-loop buttons sets a loop in the ‘A’ slot, following the rules above. Turning a loop off using the auto-loop buttons returns you to the loop slot that you were previously in at the time you started auto-looping. Turning the loop off using the LOOP button leaves you in the ‘A’ slot. The ‘A’ slot is not saved to disk automatically, pressing ‘save’ saves the loop to the first empty slot in 1-9.

Auto-looping shortcut keys are alt-1 to 5 for the Left Deck, and alt-6 to 0 for the Right Deck. They correspond to the looping buttons as laid out on screen. ie. if the onscreen buttons display 1 2 4 8 16 beat loops, alt-1 triggers a 1 beat loop, and alt-5 triggers a 16 beat loop.

## Loop Roll

Loop roll performs a standard auto-loop, but when the loop is turned off, the playback position is returned to the position where it would be if it had not entered the loop (much like censor).

The other difference between loop roll and standard auto-loop is the “roll” button is momentary. The loop is engaged when the button is pressed down, and disengaged when the button is released. Use short loop lengths to create “stutter” type effects.

To activate loop roll, hold control + alt while clicking on the desired autoloop increment, or use the keyboard shortcuts: control + alt + 1 through 5 for the Left Deck and control + alt + 6 through 0 for the Right Deck. (ie. the same as the auto-loop controls with the additional ‘alt’ key as a modifier).

The range of values available for loop roll are 1/32 through to 32 beats. The shortcut keys will activate whichever loop lengths are visible on screen, i.e., if you have lengths of a 1/4 beat through to 4 beats visible for the Left Deck, control + alt + 1 will activate a 1/4 beat loop roll, control + alt + 2 will activate a 1/8 beat loop roll and so on.

Use the ◀ and ▶ buttons to toggle through the range of possible lengths visible onscreen.

## Loop Roll with MIDI

You can assign loop roll to MIDI two ways:

1. After pressing the **MIDI** assign button in Scratch Live, press the control + alt keys, click on an auto-loop value, then click on the button/slider you want it mapped to on your MIDI controller.
2. You can assign the singular loop roll button to MIDI, then assign a MIDI knob or slider on your controller to the autoloop select knob (visible in the MIDI assign panel area when in MIDI assign mode) to change the values on the fly.

**TIP: When you have the “Autoloop Select” knob assigned to MIDI, you have all of the loop roll lengths at your disposal. This allows you to roll up and down the loop length scale, to create interesting stutter and build-up effects.**

**NOTE: Like auto-loop, loop roll requires a BPM value written to the ID3 tag in order to work. Build overviews with the “Set Auto BPM” box checked and the proper range for your music selected to ensure an accurate BPM value. See “Set Auto BPM” on page 20**

**To use the Loop controls on the Sixty-Two, see “Loops Manual / Auto” on page 10.**

# SP-6 Sample Player

The SP-6 Sample Player allows you to play up to six sources of audio, in addition to the tracks playing on the Virtual Decks. Any audio file in your Scratch Live library can be loaded to any one of the six slots, allowing playback of short samples, sound effects, or full length tracks.

The SP-6 is enabled when the Sixty-Two is plugged in, but not operational in the offline player mode.

Click on the SP-6 button to access the sample player window.

In the top right corner of the SP-6 there is a button which opens the Display Menu. Clicking on this drops down a menu with the list of available controls:



- **Mode:** Chooses the play mode: Trigger / On-Off / Hold / Repeat modes.
- **Output Select:** Assigns individual slot outputs to L (Left channel), A (Aux output), R (Right channel) or to the master output of the SP-6.
- **Pitch:** Pitch Slider / Bend / Nudge / Keylock controls.
- **Play from:** Choose which cue point / loop to use for the loaded track.
- **Overview:** Displays the overview of each track.
- **Level:** Individual sample slot level and Gain controls.
- **Level meter:** Displays the volume level for the sample slot.

This enables you to set up the sample player with the appropriate controls that suit your workflow.



## SP-6 Pitch Controls

There are individual Pitch Slider, Bend,



Nudge, and Keylock controls for each sample slot. The BPM is also displayed next to the pitch slider. If no BPM is present in the tracks ID3 tag, the pitch of the track is displayed as a percentage.

Click and drag the pitch slider to make regular pitch adjustments. Hold the shift key and move the pitch slider to make fine pitch adjustments.

Click on the + and – buttons to nudge the track into time. (temporary pitch adjustment)

Hold the ctrl key and click the + and – buttons to make ultra-fine pitch adjustments to nudge the track, adjusting the pitch permanently.

## SP-6 ‘Play From’ Selector

Use the “Play From”



selector to choose where the track will play from. You can choose to play a track from the start of the file, any one of the cue points, or any one of the loop in points.

When this is set to play from start, or play from a cue point, the track will play right through until stopped. When a loop is selected, the track will play until the loop out point, unless you have “repeat” on, in which case the track will loop using the in and out points of the selected loop.

The number of options will be dependent on the number of cue points and loops already set in your track. i.e if the track loaded has no cue points and loops set, then only “start” will be available as a “Play From” option.

**TIP: To set or adjust cue and loop information for a track, load it to a Virtual Deck, make your adjustments, then load it back into the sample slot.**

## Loading the SP-6

To load a track to the SP-6, drag and drop the desired file from your library into one of the sample slots. To eject a track, click the eject button to the right of the title display.

**TIP: You can load tracks to the SP-6 with the keyboard shortcuts: ctrl + alt + z to n.**

**TIP: Select and drag six tracks from your library onto the first sample player slot to simultaneously load six tracks across all six slots.**

## Playing Samples

Pressing the play button on each slot will play the loaded audio.



**TIP: Use the shortcut keys**

**z (slot 1)    x (slot 2)    c (slot 3)**  
**v (slot 4)    b (slot 5)    n (slot 6)**  
**to trigger each sample respectively.**

## SP-6 Instant Doubles

You can instant double from the Virtual Decks down to the SP-6, from the SP-6 up to the Virtual Decks and also between the sample slots themselves. This means the position, track gain and speed will match when you drag a track to from one location into another. This allows you to beat match tracks with your turntables/ CD players on the Virtual Decks, and then “instant double” the track down to a slot, freeing up the Virtual Decks to continue your mix with other tracks. Click and drag an already playing track from a Virtual Deck or sample slot and drop it on another sample slot to begin instant doubling.

## SP-6 Play Modes

Each sample slot has three different play modes:

**Trigger mode** - When play is pressed, the audio plays through until the end of the track. Pressing repetitively will trigger the audio from the beginning of the track. To stop the audio, hold the alt key while either clicking the play button, or pressing the corresponding shortcut key (e.g., alt - z for slot one).



**Hold Mode** - The sample will only play while you press and hold the play button or the corresponding shortcut key. Upon release of the play button, the audio stops immediately. This mode most closely resembles the function of the “note off” mode found on many samplers.



**On / Off Mode** - When play is pressed, the audio plays through until the end of the track. Pressing play again stops the audio.



**Repeat Mode** - Each slot has a repeat button. When activated, this will repeat the loaded audio file from beginning to end, or will turn on the loop selected in the “Play From” field.



**TIP: Short “loop” samples can be turned into a continuous track using the repeat function. Ensure there is a clean cut at the start and end of a bar.**

**TIP: If you don’t wish to use the SP-6, you can disable it in the Plugins tab on the Setup screen.**

**SP-6 Track Overviews**

Displays an overview of the track loaded to each sample slot. The waveform, play head position, cue points and selected loops will all be visible.

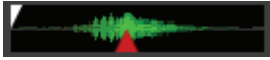

**SP-6 Slot Volumes**

Each individual sample slot has a separate volume slider and gain control.



**Volume Sliders** - Use the volume slider to mix and make temporary adjustments to the volume of the sample you are playing. These sliders act like your mixer's, fading from full volume right through to completely silent.

**Gain Knobs** - In addition to the volume slider there is an additional gain knob for each slot. These allow you to fine tune the maximum gain volume of the loaded sample. The gain adjustment will also be written to the track's ID3 tag, meaning that it will be the same everytime you load it.

**SP-6 Output Selector**

Use the master output selector button to choose where you wish to have the SP-6 output to.



**L** to PGM 1 with **A** or **B** selected as the PGM Source.

**A** to **AUX**.

**R** to PGM 2 with **A** or **B** selected as the PGM Source.

There is also a master sample player **Gain** knob to adjust the overall SP-6 volume.



**Individual Output Selectors**

By default each sample slot will be set to Master, mirroring the SP-6 master output setting. You can however, use the individual output selector buttons to override the Master output setting.



To send an individual slot to a different output from the Master, deselect the master option by clicking on the MASTER button for the corresponding slot.

This will unlink the sample slot from the master sample player output selection, allowing you to choose the 1, 2, 3 or 4 PGM output for each slot. These output routings will be saved when you close down Scratch Live, so the next time you launch Scratch Live, your preferred settings will remain the same.

**SP-6 Sample Banks**

The SP-6 has four separate sample banks, labeled A, B, C and D. To switch between the different banks click on the A, B, C or D buttons. Each bank will save the individual sample and sample slot settings you last used, allowing you to prepare banks for easy recall at a later stage. Sample Bank A will load as the default.



**SP-6 Mute Buttons**

Use the mute buttons to mute the audio output for each of the SP-6's sample slots. Click the mute button to silence the audio output, click the mute button again to turn the audio back on.



You can also ctrl-click on the mute buttons to mute the outputs momentarily, meaning that the audio will only be muted for as long as you hold your mouse click.

**TIP: You can MIDI assign these buttons, allowing you to create a virtual kill switch for the sample slot. To MIDI assign momentary mute, hold ctrl and click on the mute button before tapping your MIDI controller.**

**SP-6 MIDI**

All features of the SP-6 are MIDI assignable. The SP-6 window must be opened first before enabling MIDI assign mode. **See "MIDI Control" on page 32.**

**To trigger samples from the Sixty-Two, see "Cues / Samples control" on page 10.**



The DJ-FX Plugin gives you control of two FX units, each with three chained effects slots per unit. Each FX unit has two control modes: Ultra Knob Mode and Super Knob Mode, both of which can be fully customized. The DJ-FX plugin opens in Ultra Knob Mode by default.

The DJ-FX Plugin must be enabled in the Plugins tab in the setup screen. Once enabled, the DJ-FX panel button appears in the panels area on the main screen.

**See "Enable DJ-FX" on page 45.**

To enable post-fader DJ-FX with the **INSERT** button, **see "Enable Mixer DJ-FX Send" on page 45**

**NOTE: The DJ-FX plugin is not visible if your Rane hardware is not connected.**

**Ultra Knob Mode**

Click the Ultra Knob Mode button to select Ultra Knob Mode. This allows you to control up to three effects slots in one FX unit using the one Ultra Knob.



Click on the drop down menu to load an Ultra Knob effect. (This is "empty" before settings are saved in Macro Edit Mode.)

Click the **ON** button to enable the effect, and use the Ultra Knob to control the wet and dry amount of all effects.



Click the Show Parameters button to show the effects and parameters that are controlled by the loaded Ultra Knob preset.



## Super Knob Mode

Super Knob Mode allows you individual control of each effect in the FX unit. Each effect slot has a Super Knob which controls the wet and dry amount for the effect. 

Click the Effects drop down box to select an effect for the effect slot. You can leave a slot empty by selecting “empty.”

Click the **ON** button by the Super Knobs to toggle turning the effect(s) on and off.

The effects chain works in series going from effects slots 1 to 3, meaning that the effected audio from slot 1 passes through slot 2, which is then passed through slot 3.

## Effects BPM Multiplier

The Effects BPM Multiplier is used to adjust the effect time. The effect time is set using the track’s BPM value, but by applying the Effects BPM Multiplier you can increase or decrease the effect time. 

## Deck Assign

You can select which Deck the FX unit applies to by clicking the **Deck** buttons. Each Deck can only pass through one FX unit at a time. You can assign the Sixty-One PGM FlexFX buttons control DJ-FX: in the Plugins tab of the Setup screen, turn on “**Enable Mixer DJ-FX Send**” on **page 45**. The software Deck buttons are not visible with this enabled.

## Show Parameters

Press the Show Parameters button to expose the individual parameters for each effect. You can then control the individual parameters by adjusting their respective knobs. 









In Ultra Knob Mode, use this to select which effects are loaded and controlled by the Ultra Knob.

In Ultra and Super Knob Mode, you can link or unlink a parameter to the Super Knob by pressing the Link Button, allowing one master control of some parameters and individual control of others.

## Macro Edit Mode

Macro Edit Mode is an advanced option that allows you to create macro mappings for each effect and to save any effects edits made in Ultra or Super Knob Mode. Open Macro Edit Mode by clicking the Macro Edit Button while Show Parameters is open. Once opened, more controls appear which allow you to create and change parameter mappings. 

To map a parameter to the Ultra or Super Knob:

1. Unlink the parameter that you want to map to the knob. The Macro Min and Max buttons for this parameter are now displayed. 
2. Move the Ultra or Super Knob to the position that you want the parameter to start mapping from. 
3. Move the Parameter Knob to the position that you want the to be the lowest value of the parameter. 
4. Press the Macro Min button to set the minimum position. 
5. Move the Ultra or Super Knob to the position that you want the parameter to end being controlled from. 
6. Move the Parameter Knob to the position that you want the to be the highest value of the parameter. 
7. Press the Macro Max button to set the maximum. 
8. Link the parameter to the Ultra or Super Knob by pressing the Link button. 

Now when you adjust the Ultra or Super Knob you will see the parameter knob move within the range that you just specified. Any parameters not customized but linked to the Super or Ultra Knob will behave as normal.

You can save any macro mappings you have made to an effect by clicking the Save button by the Super Knob, and save effects combinations made in Ultra Knob Mode by clicking the Save button by the Ultra Knob. 



# MIDI Control

The MIDI Control feature in Scratch Live provides the ability to map MIDI controls to Scratch Live controls, and thus control the functions of Scratch Live using MIDI controllers such as keyboards, triggers, sliders, and knobs. Integrating MIDI controllers into your Scratch Live setup can improve live performance usability, such as hitting pads on a MIDI controller to trigger loops and cue points.

## MIDI Controller Setup

The process of setting up a MIDI controller for use with Scratch Live will vary depending on the hardware in question. Many devices can connect to a computer using MIDI over USB, and will either be supported directly by your operating system, or require installation of drivers and configuration utility software. Follow the manufacturers instructions for installation.

Other controllers may solely use a MIDI out connector to send control messages, and will require a separate MIDI interface unit to communicate to software. Generally the MIDI interface will come with drivers and configuration tools which pass your controller's output onto an available MIDI channel, which can be used by Scratch Live.

Once your controller is installed and functioning correctly, use these directions for assigning controls.

## Assigning Controls

To enable MIDI assign mode, click the MIDI button. Hovering the mouse pointer over a control shows the MIDI assignment box with the current assignment status.



To assign a MIDI control, click on the control in Scratch Live, then move the MIDI control. The MIDI assignment box should update to show it has mapped the controls to one-another.

To un-assign a MIDI control, click on the control in Scratch Live, and press return on your computer keyboard.

While in MIDI assign mode, controls which have MIDI inputs assigned show a green box indicator around them.

**NOTE: Once in MIDI assign mode, Scratch Live controls will no longer respond directly to the mouse. If you need to change a control using the mouse, disable MIDI assign mode.**

## MIDI Output Lighting

Any mappable software feature with an ON / OFF state (rather than momentary or toggle) has a lighting option. The light on the MIDI controller will stay ON when the function is ON rather than just lighting up when it is touched on the MIDI controller. You can disable it by pressing "L" whilst mapping. There is an "Enable MIDI Output Lighting" checkbox for global default in the MIDI Presets panel of the Setup screen.

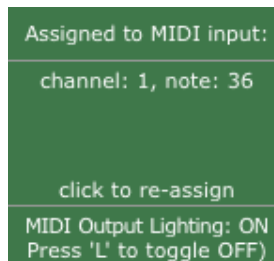

## MIDI Platters

The Scratch Live Virtual Decks are not user assignable to MIDI control. MIDI devices with platters on them all send different data so user mapping is not possible. To control the platter use a natively supported controller.

## Assign MIDI to Other Controls

Controls which are not normally visible are available for assignment in MIDI assign mode by clicking on the **Show MIDI Panel** button. This will open up a panel allowing MIDI assignment for controls including library navigation as well as additional Deck functions such as fine pitch control and extended cue and looping features.



## Ctrl-Click Functionality

Some Scratch Live screen controls have additional functionality assigned to ctrl-click. You can assign ctrl-click functionality to a MIDI control, alongside the normal functionality. For example, ctrl-click on the INT mode pitch slider returns pitch to zero. To assign this to MIDI control, enter MIDI assign mode, ctrl-click on the slider, and then assign one of the pads to it. When you press the pad, pitch goes to 0.

## Presets

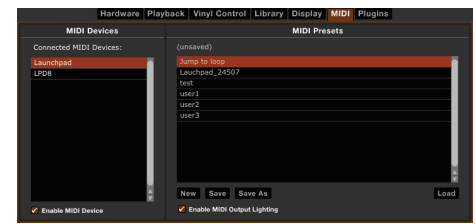

MIDI presets are accessible in the MIDI panel of the Setup screen. By default, the current MIDI assignments in Scratch Live are automatically remembered and loaded next time you start the program. The preset panel allows you to save and recall several different MIDI setups. This is useful if you are using several MIDI devices or want to quickly switch MIDI setups without having to reassign all your controls.

Make sure to create a new preset **before** you start MIDI-mapping so when you are finished there will be a preset to save to — just clicking 'New' will wipe your current MIDI settings.



**Native Controller Support**

This Scratch Live version currently has native support for the following 3rd party controllers:

- Denon DJ DN-HC1000S
- Denon DJ DN-HC4500
- Novation Dicer
- Vestax VFX-1
- Pioneer CDJ-350
- Pioneer CDJ-400
- Pioneer CDJ-850
- Pioneer CDJ-900
- Pioneer CDJ-2000
- Pioneer CDJ-2000nexus
- Pioneer MEP-7000

These controllers are plug and play, and can automatically control Scratch Live with no MIDI assignment necessary. Visit [serato.com](http://serato.com) for documentation on using these controllers.

**MIDI Devices**

Any connected MIDI device will be listed within the MIDI Device List in the MIDI panel of the Setup screen. You are able to enable or disable any of these devices using the “Enable MIDI Device” checkbox.

**MIDI Mapping**

When using Serato Scratch Live software, the mixer is plug-and-play with all required MIDI mapping done for you. For advanced users or with third-party DAWs, it is possible to custom MIDI-map most mixer controls on the Sixty-Two and control the lighting and color of buttons in the Scratch Live control strips. **See the charts in the Appendix for “MIDI Implementation” on page 53.**

- There are three groups of MIDI controls:
- Those associated with PGM 1 and the left-hand control strip.
  - Those associated with PGM 2 and the right-hand control strip.
  - Mixer controls not associated with PGM 1, PGM 2 or either control strip.

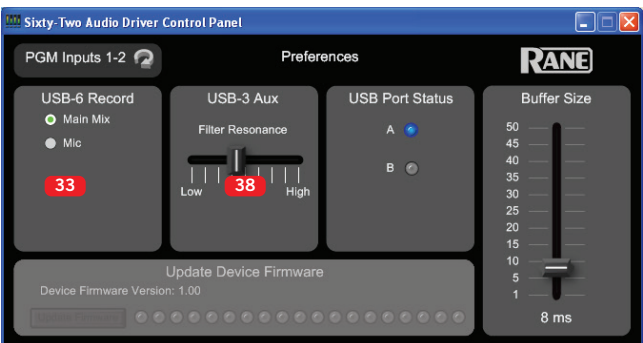
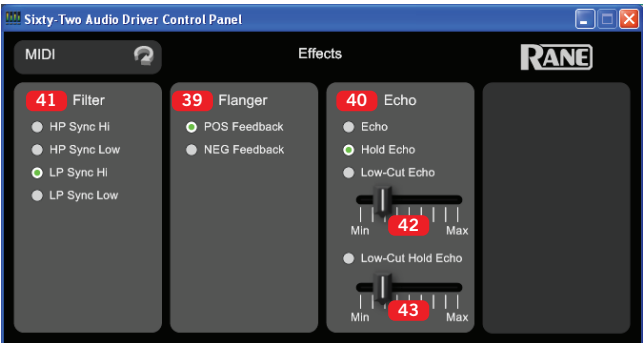
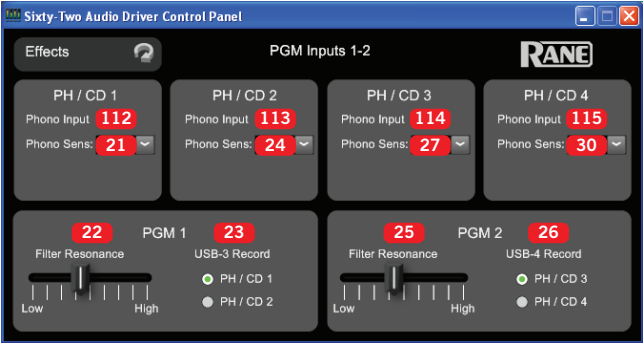
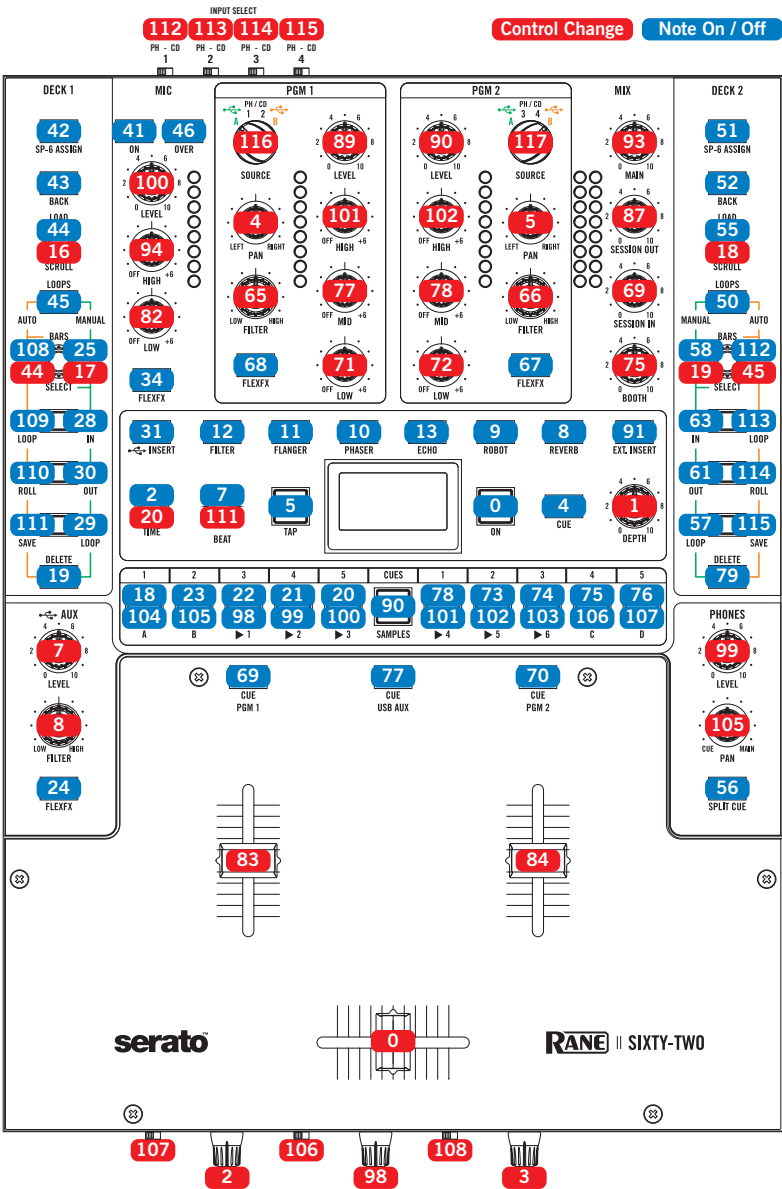

There are two USB ports on the mixer, **USB A** and **USB B**. Users can assign each of these three groups to **USB A** or **USB B** as follows:

- The **SOURCE** selector for PGM 1 determines which USB port will be used for PGM 1 controls and the associated left-hand control strip.
- The **SOURCE** selector for PGM 2 determines which USB port will be used for PGM 2 controls and the associated right-hand control strip.

To assign MIDI controls not related to PGM 1 or PGM 2, press the **SP-6 ASSIGN** button at the top of a control strip and it will light brightly to indicate that controls belonging to the third MIDI group are assigned to the same USB port. The one exception is the crossfader, which is always sent to both USB ports.

### MIDI Assignments

As indicated in the Top Panel MIDI Assignments graphic, there are unique MIDI assignments for Loop controls when in AUTO and MANUAL modes. There are also unique MIDI assignments for Cue and Sample buttons when in CUE and SAMPLES modes.

### MIDI Layers

The mixer is capable of changing MIDI Layers in order to MIDI map one control to multiple functions under different contexts. Changing the MIDI Layer is the same thing as changing the MIDI channel. The MIDI Layers used for Left Deck and Right Deck can be independently selected. The third group of controls that is not associated with PGM 1, PGM 2 or either control strip will use the MIDI Layer of the group that it is assigned to with the **SP-6 ASSIGN** button. By default, the other MIDI Layers inherit the functionality of the first Layer. The crossfader is the only control that will only send traffic on MIDI Layer 1.

- Holding down the **CUES / SAMPLES** button will turn all of the Cue buttons yellow. The Left Deck Cue buttons and Right Deck Cue buttons will each have one Cue button brightly lit. The button that is brightly lit indicates the current MIDI Layer for that group.
- While holding down the **CUES / SAMPLES** button, press the Cue button corresponding with the desired MIDI Layer. This will change the MIDI Layer for the deck that Cue button belongs to. It is not necessary to wait for the Cue buttons to display the current MIDI Layer in order to change the MIDI Layer.
- MIDI layer corresponds to the MIDI channel:

MIDI LAYER	MIDI CHANNEL
1	1
2	3
3	4
4	5
5	6

**NOTE: The Scratch Live controls on the mixer’s control strips are not mappable in Layer 1 because they are reserved for the default Scratch Live functions. These controls are fully mappable in Scratch Live on all other MIDI Layers. All controls on all layers are mappable in third-party applications that support MIDI Mapping.**

## Organizing Your Music

Scratch Live can support an unlimited number of tracks – the only limitation is the size of the hard drive of your computer. A number of features are included to help you to keep your music organized and find songs quickly and easily.

### Grouping Tracks into Crates

Scratch Live supports several ways of organizing and sorting your file library. iTunes users will notice that Scratch Live can incorporate your existing iTunes library and playlists.

Scratch Live uses digital “crates” for quick access to your favorite collections. There is no limit to the number of crates you can create, and any given track can be placed in multiple crates. For example, you could organize your files into the following crates, where any one track would be filed in more than one crate:

- Hip Hop
- UK Hip Hop
- French Hip Hop
- Inst Hip Hop
- Old Hip Hop
- Hip Hop LPs
- Bunny Hop



To make a new crate, click the Add New Crate button in the bottom left corner of the main screen  (brown crate icon). To rename a crate, double click the crate name.

You can change the order of tracks within a crate by sorting by the “#” column and dragging them up or down.

**TIP: Check the 'Protect library' option in the Library tab of the Setup screen to prevent changes to your crates. If you do delete a crate by accident, you can get it back from the recycle bin / trash. Crate files have the extension .crate.**

### Subcrates

You can drag and drop crates into other crates to make subcrates. If you drag a crate to the very left of the crate panel, it will stay in the top level of the crate structure. If you drag the crate a little to the right, onto the name of another crate, it will make the crate you are dragging a sub crate of the first crate.

### Smart Crates

Smart crates update their contents by using keywords which are matched with selected tags of your music library tracks. Smart crates can be updated automatically or at your discretion.

To create a smart crate, click the Add Smart Crate button in the bottom left corner of the main screen  (blue crate icon). A popup window will open which allows you to add the rules to fill your smart crate. Press **Add Rule** to add a rule for the smart crate to match with. For each rule you can choose a field to match on from the drop down menu:

- Added (date)
- Album
- Artist
- BPM
- Comment
- Composer
- Filename
- Genre
- Grouping
- Key
- Label
- Remixer
- Song
- Whitelabel
- Year

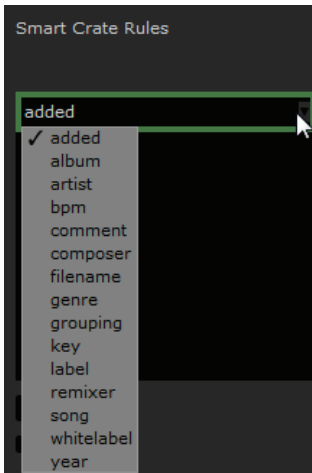

You can then choose the following inclusion / exclusion criteria:

- Contains
- Is
- Does not contain
- Is not

Check the **Match all of the following Rules** option so that tracks must match all the set rules to be added to the crate. If this option is not checked, any track which matches any of the rules will be added to the crate.

Check the **Live update** option to have the smart crate update when any tags are edited in your music library. With this option unchecked, the crate contents will be updated only when you click the refresh crate icon, which is not visible when Live update is checked.

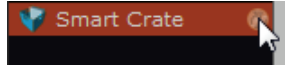

Click **Save** to save your crate or **Cancel** to exit without saving.

Click the **Edit** button (next to the Add Smart Crate button) to edit the rules of an existing Smart Crate.

### Sorting Your Files

The track information display area can be customized to display the columns listed below:

- Added
- Album
- Artist
- Bitrate
- BPM
- Comment
- Composer
- Filename
- Genre
- Grouping
- Key
- Label
- Length
- Location
- Remixer
- Sampling
- Size
- Track
- Video Track
- Year

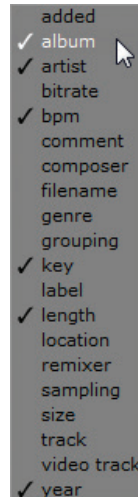

The column button  is located at the top of the library pane in the right hand corner. Click on the column button to select which columns you want to display. To sort your library by a column, click the column header so it highlights. For example, clicking on the album column

header will sort your library alphabetically by album title. To move a column, drag the header to the left or right. To resize a column, click on the column boundary and drag it to the left or right.

### Using the Song Browser



The song browser allows you to filter your song list by Genre, BPM, Artist and Album. To turn the song browser on or off, click the **Browse** button.

### Searching

Scratch Live includes a search function to help you find files quickly and easily. Enter text into the search box and Scratch Live will automatically find as you type. To select which fields the search function will look through, click on the left hand side of the search box. The drop down menu shows which fields are currently being used. Press esc or the **x** button on the right of the search box to clear the search.

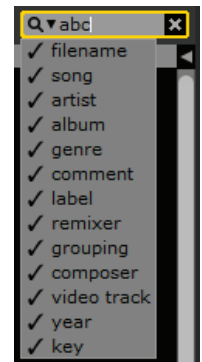

**TIP: Use the keyboard shortcut 'ctrl-f' to jump to the search box. This keyboard shortcut will also take you out of any crate or playlist that you might be in and into your main library, so you can find any track in your collection. If you then click on a crate or playlist, the search query will be cleared.**

## Prepare Window

The Prepare window is a holding area for tracks, much like preparing a set by lifting records part way out of your record bag. You can drag tracks (or whole crates) from the main track list into the Prepare window, or simply drag them onto the **Prepare** button. These tracks will be removed from the Prepare window once they have been played. All tracks in the Prepare window will be discarded when you exit Scratch Live.

**TIP: Use the keyboard shortcut ctrl-p to add tracks to the Prepare window.**

**TIP: Select the contents of the Prepare window and drag them onto the new crate button (+) to save your selection as a crate.**

## History

The **History** button opens a complete log of all the tracks you have played and allows exporting Scratch Live session information as a data file.



Each session is catalogued by date and time. Using the drop down arrow, you can navigate to and view detailed information of any previous sessions. There are columns for the period (i.e., date of session), name of track and artist name. In addition, these other categories listed below will give you more detailed information about your sessions:

**Start Time:** When viewing a song row, the start time of the song is displayed. When viewing a session row, the start time of the session is displayed with the date (in real time value).

**End Time:** When viewing a song row, the end time of the song is displayed. When viewing a session row, the end time of the session is displayed with the date (in real time value).

**Playtime:** When viewing a song row, the total played time of the song is displayed (i.e., 00:03:00). When viewing a session row, the total elapsed time of the session

is displayed with date (i.e., 10/09/08 01:38:16).

**Deck:** The Virtual Deck that the song was played on will be displayed under the deck column. In the song row, either left or right is displayed. The offline player will be listed as offline.

**Notes:** Use this field to list particular information about your songs and each session (i.e., note how you transitioned from one track to another).

### Start Session / End Session:

To start or end a session, click the corresponding button.

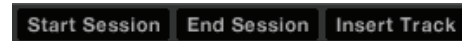

**Insert Track:** If you wish to add information for tracks not played in Scratch Live into your session (e.g., if you played one of your favorite vinyl or CDs), select the song you want to insert after and click the **Insert Track** button. Double click the inserted track fields and edit your information accordingly. When exporting an m3u playlist [see exporting below] “Inserted Tracks” will not be present.

**Export:** You can export each session as a data file using the **Export** button. Select a session, then choose your preferred file **Format**, and click **Export**. There are three possible export formats:

- **text:** to create a simple text file with your session information contained within.
- **csv:** to create a file for use in spreadsheet software.
- **m3u:** to create a playlist file, which can be imported into media players. Note that an m3u does not contain audio itself, it only points to the location of your audio files. (Inserted tracks within sessions will not be included in an m3u playlist.)
- **Serato Playlists:** see “Serato Playlists” on page 35.

**Delete:** To delete a history session, highlight the session, then press ctrl + del.

**TIP: To make a new Scratch Live crate containing your session information, select a session and drag it to the + new crate icon. The crate will automatically use the session date as the crate name.**

**Listing Behavior** - only the tracks you actually play are listed in history. This is done using an A-B algorithm, meaning a track on Deck A is only listed once the track on Deck B has been changed or ejected.

You can choose to show tracks which you have auditioned, but not actually played, by checking the **Show unplayed tracks** box. The session will then also list these tracks in grey, along with actual played tracks.

Alternatively, you can mark or unmark tracks as played manually. Select a track (or a group of tracks) and click the **Mark as played** or **Mark as unplayed** button. This may be useful if you play a track off regular vinyl or CD — breaking the A-B algorithm).

Songs that you have played are marked as green in your library. Click on the button marked **Clear** to reset the list of recently played tracks and turn the color of your library back to white.

## Serato Playlists

The Serato Playlists plugin allows you to upload your history sessions to your serato.com profile for viewing, sharing and editing. You can upload your playlist once your session is complete, or by using the Live Playlists feature to update your playlists online in real time!

To enable this plugin, go to the Plugins tab on the Setup screen and check the **Enable Serato Playlists Plugin** option. Open the History panel and you will now have access to the Serato Playlists options.

## Uploading Serato Playlists

Once you have finished your session, or to upload a previous history session, select the desired session in the History panel. Click the Format dropdown box, select **Serato Playlists** and click the **Export** button. You will receive the following warning:

Warning: This feature will submit play data from your History to your online Serato Playlists and may affect sound card performance while sending.

Do you wish to continue?

If you choose “Yes” you will then be taken to [www.serato.com](http://www.serato.com) where you can review your playlist before choosing to post it online. Once posted, you have the option to edit the playlist and track information.

**NOTE: We recommend that you turn off any wireless networking devices when using Scratch Live. If you export your playlist online whilst playing you may experience USB dropouts. If so, you may wish to avoid using this function.**

## Live Playlists

Serato Playlists has the Live Playlists option to allow you to display what you are playing online in realtime on your serato.com profile.

To enable the Live Playlists feature go to the Plugins tab on the Setup screen and check the **Enable Live Playlists** option. Once enabled, the **Start Live Playlist** button is now displayed in the History panel. Click this to start and stop your Live Playlist session.

**NOTE: Live Playlists requires you to be connected to the internet while playing, which may result in USB dropouts. If so, you may wish to avoid using this function.**

## Editing ID3 tags

Much of the information associated with each file can be edited from within Scratch Live. Double click on the attribute within the main library to edit the attribute. Filename, length, size, bit rate and sampling cannot be edited. This information is saved in the file itself. Note that the protect library option in setup must be unchecked to allow edits. **for details on auto-BPM See “Preparing Your Files” on page 20.**

**TIP: Use the keyboard shortcut ctrl-e to edit text. Hold down the ctrl key and move with the arrow keys to change to a different field while staying in edit mode. When you have more than one file selected, editing tags changes all the files in your selection.**

**TIP: The second column in the library is the label color for that file. Click it to bring up a color palette, and customize the Virtual Deck for that file.**

## Library Zoom

You can change the size of your library text by using the shortcuts ctrl + and ctrl -.

## Display Album Art

MP3 files can contain album art information. Click the **Album Art** button at the very bottom left of the screen to open a small window. This window displays the album art of the track currently selected in the library.

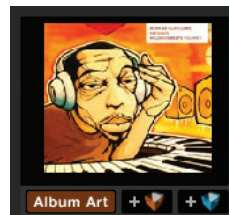





Album art can also be shown next to the track information display on each Virtual Deck. Click on the Display tab in the Setup screen to find this option. **See “Show Album Art On Deck” on page 45.**

## Adding Album Art

You can add album art to a file by dragging and dropping a jpeg or png file onto the track in any of the album art views, or onto the Album Art window. If you do this while the track is loaded to a Virtual Deck, the album artwork will not be added until the track is ejected.

## Status Icons

The leftmost column shows the status of each track. The image to the left shows five tracks with differing statuses.

- Scratch Live has detected some corruption in the MP3 file. If possible, re-encode the MP3. If you have a corrupt file in your library, hover your mouse over the status icon for information on what type of corruption was found. **See “Corrupt File Descriptions and Diagnoses” on page 47.** 
- The track has been imported from the iTunes library. 
- The track has been imported from the iTunes library, and Scratch Live has detected some corruption in the MP3 file. Solution: If possible, re-encode the MP3. 
- The track cannot be found. Most likely the file has been renamed or moved. 
- Tracks that are read-only have a locked icon. 

# File Management

Located in the files pane are two buttons, rescan ID3 tags and relocate lost files. Use these tools for ongoing file and library management.



## Rescan ID3 Tags

Click this button to force Scratch Live to re-read all file tags. Alternatively, you can drag and drop files, folders, or drives onto the rescan id3 tags button from the files pane. This will only scan the files that you drag and drop, resulting in much faster processing.

**TIP: Rescanning the tags is a handy way to identify all the files that Scratch Live can't find (for example if the files have been altered or moved). These tracks will show up red in the main track list, with an exclamation mark in the status column. You can sort by the status column to group all these tracks together.**

## Relocate Lost Files

This feature finds music and folders on your computer that you have either moved or altered.

1. Click the **Relocate Lost Files** button to search all your drives (internal and external) for files currently marked as not found in your library.
2. When this process is complete, your Scratch Live library will be updated with the new location of your files.

**TIP: Drag and drop files, folders, or drives onto the Relocate Lost Files button from the Files pane. This is**

**useful if you know the location of your files, as it only scans the drag and drop location, with faster relocation.**

## Deleting Crates and Tracks

To delete tracks from your Scratch Live library, select the track and use the keyboard shortcut ctrl-delete. Make sure you have the **Protect library** option unchecked in the Library tab of the Setup screen.

- Deleting a track when you are in the “\* All...” playlist removes it from your library and any crates that the track may be in.
- Deleting a track inside a crate removes it from that crate but the file will remain in your “\* All...” playlist.
- Deleting a track from a subcrate will remove it from the subcrate and the main crate but not the “\* All...” playlist.
- Crates that are deleted are sent to the recycle bin/trash.

**NOTE: To delete any files from your library and your hard drive (sending them to the recycle bin) use the shortcut ctrl-shift-delete.**

If you are using iTunes playlists, your files cannot be deleted this way. You will need to delete them from within iTunes.

## Copy & Move Files & Folders

Scratch Live gives you the ability to copy and move files, folders and crates between drives or to a new location on the same drive.

To copy or move your files and/or folders, open the Files panel and select, drag and drop them in the desired new location. Scratch Live will then prompt you with the following options:

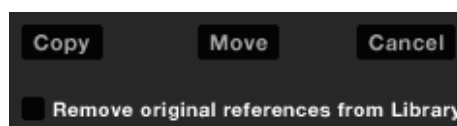

**Copy:** Select this to make a copy of the selected files and folders in the new

location. Your Scratch Live library will now contain entries for both the originals and copies.

**Move:** Select this to move the selected files and/or folders to the new location. Your Scratch Live library and crates will now reference the files in their new location.

**Cancel:** Cancel any changes.

**Remove original references from library:** Check this option when using the copy feature to remove the original references to these files in your Scratch Live library and replace them with the copies in the new location. The original files will still be kept in their current location, but will no longer be referenced in your Scratch Live library.

## Copy & Move Crates

You can also copy or move your Crates and Subcrates to another drive in the same way. Open the Files panel and select, drag and drop your Crates or Subcrates to the new drive. You will be presented with the same options as mentioned above. To move between drives, read the Scratch Live Support Articles at serato.com.

## Scratch Live Backup

Scratch Live stores your library database and crates information in the Scratch Live folder on your hard disk. This folder is created on a drive when files are added to Scratch Live. A copy of each Scratch Live folder called ScratchLiveBackup is created next to the folder it is backing up. This folder is created when exiting Scratch Live. You will be prompted to backup your Scratch Live library on exit if there is no backup for a drive or if the last backup is more than one week old.

Backup will only keep ONE level backup at a time; each time backup runs, it overwrites the previous backup.

**NOTE: Make sure you back up your music separately. This backup function only backs up the Scratch Live folder, not your music files.**

# Recording

Scratch Live allows you to record one of eight stereo signals from the Sixty-Two:

- PGM 1
- PGM 2
- Input 1
- Input 2
- Input 3
- Input 4
- Mic
- Main Mix

Stereo recording is possible even while using two stereo vinyl control inputs.

1. Select the **RECORD** button at the left of the screen to open the Record controls.
2. Choose the **Input Source** by clicking on the downward arrow (icon) to get the drop menu.
3. Click the red record icon to start recording.
4. The record icon flashes while recording and the display shows the elapsed recording time.
5. Click the flashing record icon again to stop the recording.
6. To save the recording, type in a name for the recording and click the save icon.
7. The recording is automatically placed in a crate named "RECORDED". If the crate does not already exist, it will be created automatically.
8. To start a new recording without saving, simply click the record button again.

Recordings can be loaded onto the Decks, renamed, and managed like other files. Recordings are saved as 24-bit, 48 kHz stereo AIFF files by default.

Recordings are saved in "My Documents\My Music\\_Serato\\_

Recording" in Windows XP, "Libraries\ Music\\_Serato\\_Recording" in Windows 7, and "~\Music\\_Serato\\_Recording Temp" on a Mac.

## Record Gain Knob

Adjust the record level using this Gain knob. The meter reveals the level of your audio. Ideally the meter should sit just below the red, meaning your signal is as loud as it can be without clipping.

**NOTE: If you turn the record Gain knob down and the red clip led is still illuminated, the signal is clipping the input of the Sixty-Two. If possible, turn down the level at your audio source before it reaches the Sixty-Two.**

## TIPS

- The keyboard shortcut ctrl-n turns recording on and off.
- Load a recording without saving it using the shortcut keys shift left arrow to the Left Deck or shift right arrow to the Right Deck.

**NOTE: Recording files are automatically split when the recording exceeds 3 hours (16-bit) or 1 hour 50 minutes (24-bit). See "Recording Bit Depth" on page 42.**

## Sampling From Vinyl

You can use the Sixty-Two to sample from vinyl or any other sound source. Click the ▼ triangle next to the record button to select the pre-fader signal your source is connected to.

**TIP: Remember that ctrl-n turns recording on and off, and you can load a recording without saving it using shift + left arrow or shift + right arrow. Drop the needle into a loud part of the track, record a few seconds, and then shift + left arrow or shift + right arrow to load it on to the Virtual Deck. This way you can double-check your levels and adjust with the Gain control.**

# Mixing With One Turntable Or CD Player

This single turntable technique allows you to mix as if you had two turntables, using just one. If one of your turntables is not performing properly, or if you only have one available, you will be able to continue to mix the way you are used to.

The following is a step-by-step description of how to perform a mix using only your right turntable or CDJ with the instant doubles feature.

## Menu Settings

Go to the Setup menu, click on the Playback tab. Make sure **Instant doubles** is checked, and **Lock playing deck** is unchecked.

1. Load a track onto the Right Deck in Scratch Live and play as usual.
2. Put the Left Deck into INT mode.
3. Load the same song you have playing on the Right Deck onto the Left Deck. The track on the Left Deck will start playing from the same point and at the same pitch as the Right Deck.
4. You can now quickly slide your mixer's crossfader over to the Left Deck.
5. Your Right Deck is now free to load up a new song ready to mix in.
6. Repeat!

**TIP: Instant doubles works with either Deck.**

See "Lock Playing Deck" on page 43.

See "Instant Doubles" on page 43.



# Two Computer Connection

The Sixty-Two allows two computers running Scratch Live to connect to the mixer simultaneously. This allows two DJs to play at the same time and for easy DJ handover.

Connect both computers to the two USB ports on the Sixty-Two. For each channel on the mixer, set the PGM source control to either **A** or **B** depending on which your computer is connected to.

**NOTE: If a channel is in use by a computer already, the second computer's Virtual Deck will become black and display IN USE.**

When a PGM channel is assigned to a USB port using the **SOURCE** selector, both MIDI and audio are assigned to the indicated port. MIDI assignment for PGM 1 and PGM 2 mixer controls and the associated side control strip follow the **SOURCE** selection. The color of the **SP-6 ASSIGN** button at the top of each control strip follows the USB port assignment made by the **SOURCE** selector: **GREEN** for USB A and **ORANGE** for USB B. Pressing the **SP-6 ASSIGN** button assigns SP-6 controls to the indicated port. It also assigns other mixer MIDI. See **“Control Strip Controls”** on page 9.

**NOTE: Settings are saved in the mixer. Software is updated with the mixer's settings. Therefore, the mixer may replace control source and effect settings in Scratch Live or software control panels with current mixer settings.**

## DJ Handover

Swapping between two DJs both using Scratch Live is now easier than ever! With a computer already connected to the Sixty-Two and playing, do the following:

1. Connect the second computer to the unused USB port on the Sixty-Two.
2. Switch the PGM Source on the non-playing mixer channel to the USB source of the second computer.
3. Play a track on this Deck and mix it in when ready — you'll now have audio from both computers in the mix.
4. Fade out the audio playing from the first computer to the audio playing from the second computer.
5. When only audio from the second computer is left in the mix, remove the first computer.
6. Assign the PGM Source for the remaining free mixer channel to the second computer and continue DJing.

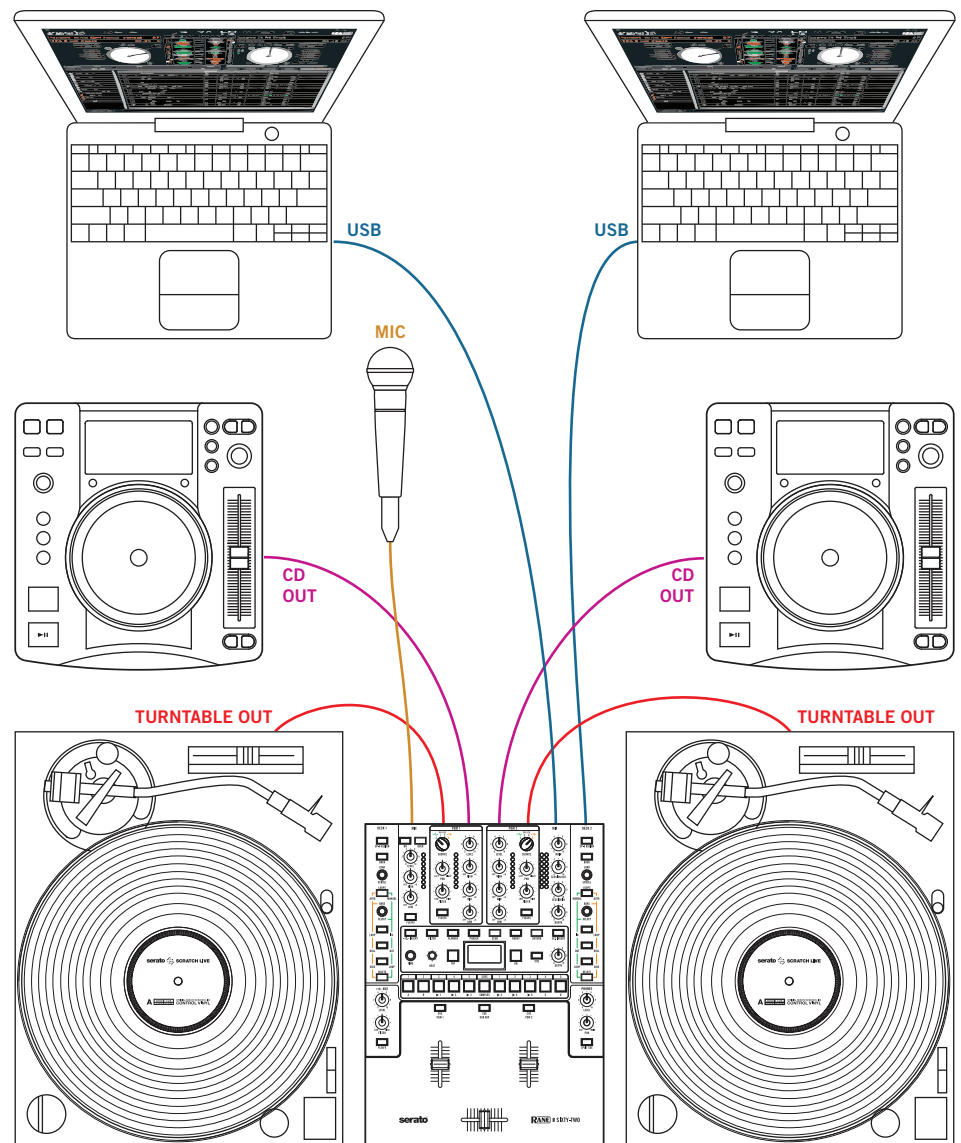



# Keyboard Shortcuts

These actions can be accessed directly from the computer keyboard.

**NOTE: Playback, cue and speed controls use Shift or Caps Lock. You can turn this off in the Setup screen.**

See “Playback Keys Use Shift” on page 43.

KEY	ACTION
<b>ctrl - L</b>	Locate the current track. This will highlight the track you most recently loaded. Pressing ctrl - L again will alternate between the tracks recently loaded on both decks.
<b>ctrl - R</b>	Reveal - the highlighted song is opened in a file browser.
<b>ctrl - F</b>	Find - moves the cursor to the search box.
<b>ctrl - A</b>	Select all.
<b>ctrl - C</b>	Copy text in edit mode.
<b>ctrl - E</b>	Edit text.
<b>ctrl - V</b>	Paste text in edit mode.
<b>ctrl - X</b>	Cut text in edit mode.
<b>ctrl - Z</b>	Undo last track load.
<b>shift - ctrl - ↑</b> <b>shift - ctrl - ↓</b>	Move focus up / down through the library or crates. Note that if you have a song highlighted in the song view, and use shift - ctrl - ↑ ↓ you will move up or down through the library or crates. When you release the shift or ctrl key, the focus will go back to the song view so that you can move up and down through songs using ↑ ↓.
<b>ctrl - P</b>	Add tracks to the prepare window.
<b>ctrl - N</b>	Start a new mic recording.
<b>ctrl - O</b>	Open the track in your default MP3/WAV/OGG/AIF player.
<b>- or +</b>	Zoom the main waveform display.
<b>ctrl - or +</b>	Zoom the library text size.
<b>tab</b>	Alternate focus between crates or songs.
<b>ctrl - del</b> and <b>ctrl - backspace</b>	Remove track from library., remove track from crate, delete crate (does not delete the file).
<b>alt - del</b> and <b>alt - backspace</b>	Remove track from crate and from library.
<b>ctrl - shift - del</b> and <b>ctrl - shift - backspace</b>	Delete the file from your library <i>and</i> send to the recycle bin. (Note to iTunes users: files in your iTunes library cannot be deleted this way).
<b>ctrl - shift - /</b>	Toggle the input reverse switch.
<b>~</b>	Toggle the Flashing Deck indicator between the Primary and Secondary Decks.
<b>esc</b>	Clear search string if searching, or exit Scratch Live.

SAMPLE PLAYER	slot 1	slot 2	slot 3	slot 4	slot 5	slot 6
Load to sample slot	<b>ctrl - alt - Z</b>	<b>ctrl - alt - X</b>	<b>ctrl - alt - C</b>	<b>ctrl - alt - V</b>	<b>ctrl - alt - B</b>	<b>ctrl - alt - N</b>
Play sample slot	<b>Z</b>	<b>X</b>	<b>C</b>	<b>V</b>	<b>B</b>	<b>N</b>

LEFT DECK	ACTION	RIGHT DECK
<b>ctrl - ←</b> or <b>shift - ←</b>	Load the highlighted song to a deck.	<b>ctrl - →</b> or <b>shift - →</b>
<b>ctrl - shift - →</b>	Load the track currently on one deck onto the other deck as well.	<b>ctrl - shift - ←</b>
<b>shift - alt - ←</b>	Unload the track from a deck.	<b>shift - alt - →</b>
<b>ctrl - , (comma)</b>	Place a cue point.	<b>ctrl - . (period)</b>
<b>ctrl - 1, 2, 3, 4, 5</b>	Place a cue point in a slot.	<b>ctrl - 6, 7, 8, 9, 0</b>
<b>1, 2, 3, 4, 5</b>	Jump to cue points slots. (REL and INT modes)	<b>6, 7, 8, 9, 0</b>
<b>F1</b>	Switch deck to ABS mode.	<b>F6</b>
<b>F2</b>	Switch deck to REL mode.	<b>F7</b>
<b>F3</b>	Switch deck to INT mode.	<b>F8</b>
<b>F5</b>	Key lock on / off.	<b>F10</b>
<b>Q</b>	Play / pause reverse.	<b>A</b>
<b>W</b>	Play / pause forward.	<b>S</b>
<b>E</b>	Pitch down.	<b>D</b>
<b>R</b>	Pitch up.	<b>F</b>
<b>T</b>	Bend down. (REL and INT modes)	<b>G</b>
<b>Y</b>	Bend up. (REL and INT modes)	<b>H</b>
<b>U</b>	Censor. (REL and INT modes)	<b>J</b>
<b>I</b>	Go to temporary cue point. (REL and INT modes)	<b>K</b>
<b>O</b>	Set / adjust loop in-point.	<b>L</b>
<b>P</b>	Set / adjust loop out-point.	<b>;</b>
<b>[</b>	Loop on / off.	<b>'</b>
<b>ctrl - [</b>	Jump to selected loop.	<b>ctrl - '</b>
<b>alt - Q</b>	Load previous track.	<b>alt - A</b>
<b>alt - W</b>	Load next track.	<b>alt - S</b>
<b>alt - 1, 2, 3, 4, 5</b>	Auto loop on / off.	<b>alt - 6, 7, 8, 9, 0</b>
<b>ctrl - alt - 1, 2, 3, 4, 5</b>	Loop roll.	<b>ctrl - alt - 6, 7, 8, 9, 0</b>
<b>alt - E</b>	Rewind. (REL and INT modes)	<b>alt - D</b>
<b>alt - R</b>	Fast forward. (REL and INT modes)	<b>alt - F</b>
<b>alt - O</b>	Previous loop.	<b>alt - P</b>
<b>alt - L</b>	Next loop.	<b>alt - ;</b>
<b>alt - space bar</b>	Activate the tempo tapper.	<b>alt - space bar (x2)</b>
<b>ctrl - I</b>	Set temporary cue point. (REL and INT modes)	<b>ctrl - K</b>

# Additional Setup

This section covers general preferences and adjustments you can make to improve the performance of Scratch Live. From the top of the main screen, click on **SETUP** to get to this area.

## Hardware: General

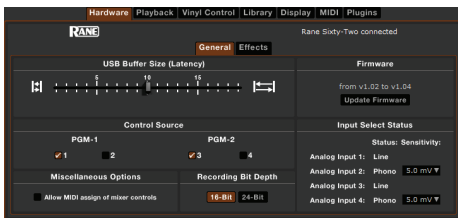

### USB Buffer Size (Latency)

Scratch Live processes audio in small chunks. When smaller chunks are used, the movement of the record is translated into audio more often, which results in a lower overall system latency. However, this requires more processing and therefore a higher CPU load, so lower buffer size settings require a more powerful computer to produce uninterrupted audio. If you want tighter control, try decreasing this setting. On the other hand, if you experience audio dropouts, you need to increase this setting (or use a more powerful computer).

## Updating Firmware

If a firmware update is available after installing a new Scratch Live software release, an **Update Firmware** button appears in the Hardware screen. During the firmware upgrade the Sixty-Two will not be usable. Only connect one USB port during a firmware update.

## Control Source

Select the Input you wish to use as your control source for both PGM 1 and PGM 2. Select 1 or 2 for PGM 1 and 3 or 4 for PGM 2.

The default control sources are Inputs 1 and 3. To reset the defaults of Control Sources, Phono Sensitivities, Channel Filter Resonances, Flanger, Echo and Filter Type to default settings, See **“Factory Defaults”** on page 15.

## MIDI Assign of Mixer Controls

Check this box to allow the mixer controls to be custom MIDI-mapped in Scratch Live. See **“MIDI Mapping”** on page 41.

## Input Select Status

The input level currently set on the Sixty-Two is displayed for each input. To change the input level setting, use the switches on the Sixty-Two. Choose **PH** for Phono and **CD** for Line level.

When Phono is selected, the **Phono Sensitivity** setting is also displayed. Click the down-arrow to display a list of 16 sensitivity settings between 2.5 mV and 10 mV in 0.5 mV steps. The default is 5 mV. Set the Phono Sensitivity to the same level of your cartridge (see your cartridge documentation for the correct value). Another method is to match the level of a CD on another input.

## Recording Bit Depth

Choose to record in either **16-Bit** (CD quality, smaller file size) or **24-Bit** (high quality, larger file size). see **“Recording”** on page 39.

## Hardware: Effects

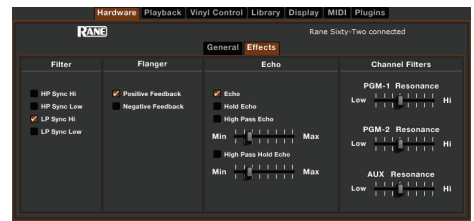

### Filter

Choose between:

- High-Pass Sync High
- High-Pass Sync Low
- Low-Pass Sync High
- Low-Pass Sync Low

### Flanger

Choose between modes:

- Positive Feedback
- Negative Feedback

### Echo

Choose between:

- Echo
- High Pass Echo
- Hold Echo
- High Pass Hold Echo

For High Pass Echo and High Pass Hold Echo, you can adjust the cutoff frequency of the High Pass filter.

### Channel Filters

Adjust the Resonance for the PGM 1, PGM 2 and AUX channel filters. High Resonance adds a “zip” effect to the Filter when it is moved. Low resonance is best when the Filter is used for mixing to extreme lows or highs.

See the **“Effects Parameter Table”** on page 13.

Default Effects settings are:

- Low-Pass Filter with high-frequency sync.
- Flanger with positive feedback.
- Echo with no feedback filter.
- Echo filter frequencies to 82 Hz.

To reset the defaults of Control Sources, Phono Sensitivities, Channel Filter Resonances, Flanger, Echo and Filter Type to default settings, See **“Factory Defaults”** on page 15.

## Playback



### Track End Warning

Enable this option to flash the Virtual Deck as you approach the end of the track. The label will start flashing 20 seconds from the end of the record. The Track end warning does not apply to any tracks under 1 minute long.

### Playback Keys Use Shift

When this option is checked you must have the shift key pressed for the playback keys to trigger. This applies to all keyboard shortcuts, including cue points, INT mode shortcuts, and the sample player shortcuts.

**TIP: You can also turn on Caps Lock instead of using Shift.**

### Lock Playing Deck

Every DJ's nightmare used to be lifting the needle off the wrong turntable in the middle of a set. This setting helps to avoid the digital equivalent; loading a new track to the wrong Deck. When this option is checked, you can only load a track if the target Deck is stopped.

### Sort Cues Chronologically

The five cue points can be placed in any order, and can be dragged up and down if you wish to reorder them. If you prefer to lock them to chronological order, turn this option on.

### Enable Hot Cues

When Hot Cues are enabled, you can set cue points simply by pressing the number keys 1 through 0 (no ctrl modifier required) from your keyboard. You can only add cues this way if the cue point slots are empty. **See "Cue Points" on page 26.**

### Use Auto Gain

Auto gain enables you to set a uniform volume level for the tracks in your library. When a track is in auto gain mode, the track gain knob appears recessed.

Check this box to enable auto gain. Provided you have analyzed your files, your tracks will now be loaded with the auto gain applied.

Next to this box is a drop down menu, in which you set the target gain volume level.

To find the optimum setting, load a track with an average volume level onto one of the Virtual Decks. Now play the track, and take note of the volume and LED lights inside the software.

The idea is for the track volume to be sitting just under the clipping point (indicated by the LED meter red-lining). If the track is too quiet, unload it, then go to the Playback setup screen and boost the auto gain dB value more.

Once you've made this adjustment, load the same track onto the Virtual Deck again. You'll notice that the volume knob has automatically adjusted itself.

Keep making adjustments on the same track until it's just below the clipping point. Once this is set you won't need to adjust the target gain level ever again.

Because the track you used had an average volume level, most of the other tracks in your library should be around the same volume. You may still need to make minor adjustments to some individual tracks, but once that's done these will stay saved in the ID3 tag of the file.

**TIP: Slightly too quiet is always better than too loud. If your LED meter is in the red, it is likely that it is clipping. Not only does clipping not sound very nice, it can damage your equipment.**

### Hi-Fi Resampler

This significantly reduces digital distortion at very slow or very fast record speeds, increasing the CPU load slightly. This option is off by default, the old resampler is used when switched off.

### Play From Start

Enable this to start all tracks from the beginning when loaded in REL and INT modes. If this setting is not enabled, freshly loaded tracks will continue to play from the point the last track was at. This option is on by default.

### Instant Doubles

This option allows you to quickly match the playhead position of two tracks. With this option enabled, when you load the same file on one Virtual Deck that is already loaded on the other Virtual Deck, the playhead will jump to the position of the track that was loaded first, with the keylock state and looping settings copied. This setting overrides the **Play from start** and **Play from first cue point** options.

### Play From First Cue Point

Enable this option to start all tracks from the first cue point when loaded in REL and INT modes. This setting overrides the **Play from start option**.

### Braking

#### (Internal Mode)

In INT mode, this controls how fast the deck stops when play is stopped. Counter-clockwise, the stop is immediate. Clockwise rotation increases the stop from a finger grab all the way to a slow turntable power-down.

### Audio Output

By default the output of Scratch Live is stereo. You can also select mono output. This setting is saved when you exit Scratch Live.

## Vinyl Control

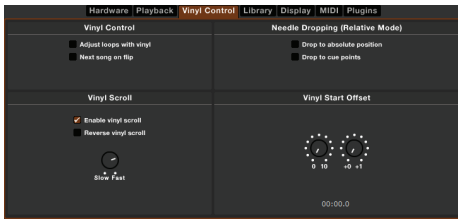

### Adjust Loops with Vinyl

Loop end points can be adjusted using the control vinyl. Disable this option if you wish to use the computer's arrow keys to adjust loops, and keep audio playback controlled by the vinyl. **See "Looping" on page 27.**

### Next Song On Flip

When this option is enabled, changing the side of control vinyl you're using ('flipping the record') loads the next song.

### Enable Vinyl Scroll

Uncheck this box to disable the Vinyl Scroll feature. **See "Vinyl Scroll" on page 21.**

### Reverse Vinyl Scroll

This setting allows you to reverse the direction of Vinyl Scroll. **SEE "Vinyl Scroll" on page 21.**

### Vinyl Scroll Speed

Vinyl Scroll allows you to load a new track without touching the computer, by lifting the needle and placing it in the special section of side A of the control record. This setting allows you to adjust the sensitivity of Vinyl Scroll, so that you can control the amount of record movement required to move between tracks.

### Drop To Absolute Position

#### (Relative Mode)

This detects a deliberate repositioning of the needle, and moves the playhead to the needle's absolute position, as if it were in ABS mode. Accidental skipping of the needle does not reposition the playhead. (REL mode only)

### Drop To Cue Points

#### (Relative Mode)

This option triggers the corresponding cue point when the needle is repositioned into one of the first five one-minute sections on the control vinyl. For instance: needle dropping into the second minute on the left turntable will send playback for Deck 1 to cuepoint 2, if that cuepoint is set. (REL mode only)

### Vinyl Start Offset

If there is cue burn at the beginning of the vinyl, you will notice that the tracking will be poor at this point. Use the two knobs to offset the start point, so that the track will start playing from a point further into the control record. The first knob sets the number of whole minutes to offset by, the second knob sets the number of whole rotations within that minute.

## Library

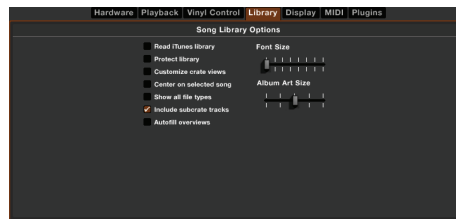

### Read iTunes Library

Check this option to show your iTunes library and playlists in Scratch Live. You can collapse your iTunes playlists by clicking on the blue folder icon. 

Uncheck this option to remove iTunes playlists and iTunes songs from your Scratch Live library.

To add your iTunes music to your Scratch Live library permanently, drag and drop tracks from the iTunes playlists onto the "\* All..." icon (on the far left hand side of the Scratch Live screen), or into individual Scratch Live crates.

Any files moved to "\* All..." an existing crate, or a new crate will now remain in Scratch Live even when the **Read iTunes library** option is unchecked. Once a file has been permanently added to Scratch Live, the iTunes logo will disappear.

We recommend unchecking this option after you have added your music into the Scratch Live library.

#### NOTES:

- If your iTunes library contains a large number of tracks it may take some time for Scratch Live to read it.
- Any changes made in Scratch Live to the file information of tracks in your iTunes library will not appear in iTunes until after you play the track.
- Scratch Live cannot play files that have been protected by Digital Rights Management systems, such as those previously sold through the Apple iTunes Music Store. iTunes Plus files are DRM-free.
- iTunes is available for Mac and PC. To get more information, visit [www.apple.com](http://www.apple.com).

### Protect Library

Uncheck this option to remove files and crates from your library. Check this option to lock your library and prevent accidental file or crate deletion while using Scratch Live. Enabling this option will also lock all file tags and crate names, so that no text can be changed.

### Customize Crate Views

Check this option to set custom column views for each crate and playlist. When the option is off (default), all crates will share the same column configuration as the "\* All..." crate.

### Center On Selected Song

With this option on, scrolling up and down in your library holds the selected track in the middle of the library panel.

### Show All File Types

Enable this option to show all files when importing tracks into Scratch Live. If this option is unchecked, only files that Scratch Live can play will be displayed.

## Include Subcrate Tracks

You can drag crates into other crates to make subcrates. If you have this option turned on, any crate will also display the contents of all its subcrates. **SEE “Organizing Your Music” on page 34.**

## AutoFill Overviews

Enable this option to automatically generate the track overview as soon as a track is loaded. If this setting is disabled, the track overview will be generated as the track plays. Automatically generating the track overview uses more of the computer’s CPU power, and should be disabled on slower computers.

**TIP: Analyze your files before you play to pre-build all your overviews. See “Preparing Your Files” on page 20.**

## Font Size

Adjust this slider to increase and decrease the font size for the main library and crates area.

**TIP: You can also use the keyboard shortcuts ctrl + and ctrl – to increase and decrease the font size.**

## Album Art Size

Adjust this slider to set the maximum album art size for any of the album art display modes. The artwork will still get larger if required to fit the track and will still scale with the library zoom keyboard shortcut.

## Display

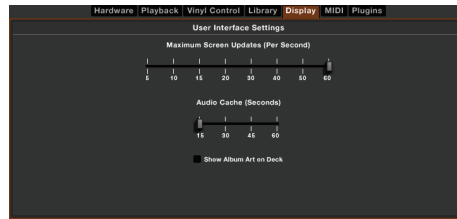

### Maximum Screen Updates

This slider allows you to throttle back the screen refresh rate. Users with slower computers might like to do this if they are having performance issues. It could also be useful if you want to limit Scratch Live’s processor usage, for example if you are running a recording program at the same time. The default setting is 60 Hz, or refreshed 60 times per second. This setting applies to the entire screen (i.e. the Virtual Decks, the Waveforms, the Library, and the Setup screen).

### Audio Cache

Use this slider to set the amount of audio that is loaded into memory. A small audio cache will place less load on your computer, and the tracks will load faster. A large audio cache will give you a bigger view of the waveform when the main waveform view is zoomed out. The default is 15 seconds.

### Show Album Art On Deck

Check this option to show the album art for your song next to the track information display on each Virtual Deck.

## Plugins

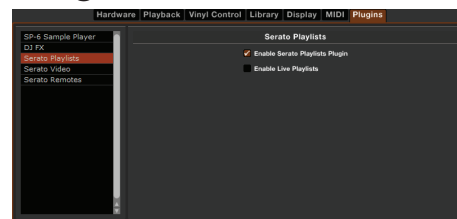

### Enable SP-6 Sample Player

Use the check box to enable and disable the SP-6 sample player plugin. The SP-6 is enabled by default.

## Enable DJ-FX

Use the check box to enable and disable the DJ-FX plugin. The DJ-FX plugin is disabled by default.

### Enable Mixer DJ-FX Send

Check this box to insert the Scratch Live DJ-FX into the Sixty-Two FlexFX loop. This allows you to assign and manipulate the software DJ-FX using hardware controls, and also makes the software effects post-fader.

Press the  INSERT button on the Sixty-Two to enable the software FlexFX loop, and then use the corresponding channel FlexFX buttons to insert DJ-FX.

### Enable Serato Playlists

Use the check boxes to enable and disable the Serato Playlists plugin and the Live Playlists feature. These are disabled by default.

### Enable Live Playlists

With this box is checked, and an active internet connection, the Start Live Playlist button in the History panel transmits what you are playing in real time to your serato.com profile. An internet connection could result in USB dropouts, therefore you may wish to leave this unchecked.

## Serato Video

This optional software plugin for Scratch Live adds the ability to play and mix video files. Serato Video is supported and available only from [serato.com](http://serato.com).

## Serato Remote

Designed to compliment an existing Scratch Live setup, Serato Remote lets you see and perform all of your favorite Scratch Live functions without needing to touch your laptop. Control Cue Points, Loops and Samples. Load tracks and manipulate FX in ways that weren’t previously possible. See Serato’s famous Virtual Decks and Track Overviews so you can focus on the crowd and free yourself from your laptop. Serato Remote is supported and available only from [serato.com](http://serato.com).

# Troubleshooting and FAQ

(Frequently Asked Questions)

## The audio playback is dropping out / clicking / popping.

Scratch Live is not getting a clear signal from the record, or your computer is not able to process quickly enough. Go to the Setup screen and check the scope views. When the record is playing, the circles should be round, and the value in the bottom right corner should be close to 100%. If this is not the case, you need to calibrate. **See “Calibrating Scratch Live” on page 18.**

Also try increasing the **USB Buffer Size** in Hardware Setup if your computer is close to the minimum spec.

Clean your needles! This is the most common cause of audio drop-out. Because you are playing the same record over and over, the needles will get dirty more quickly than usual.

## The threshold goes to the far right when I click the estimate button

Make sure the needle is on the record and the record is stopped when you click estimate. If the slider goes hard right and stays there, you most likely have an grounding problem with your turntables/mixer. If you cannot eliminate this problem, use REL mode instead of ABS mode.

## Scratch Live makes a strange digital noise, even when no track is playing

Scratch Live is interpreting background noise as record movement. In the Setup screen, move the threshold slider (located left of the Estimate button) to the right until the noise stops. **See “Calibrating Scratch Live” on page 18.**

## The tracks are playing backwards!

The inputs (from the turntables or CD players) are the wrong way around. Try swapping red and white wires at one end.

## I can't get the Scope View to show nice clean circles

Check your needles and make sure they are clean. If the circles look fuzzy, try cleaning your control record. If the Scope View shows a line instead of a circle, Scratch Live is only receiving a signal from one channel — check all your cables, and the connection between your cartridges and the tone arm. You can order replacement control records from your local distributor. You may also order these in the online store at [www.rane.com](http://www.rane.com) if you are in the USA.

## The first time I play a new track, it takes a while to load

Scratch Live has to read the entire file and create a file index (overview) the first time it is loaded. This may take a few seconds for longer files. After the first load, it should load instantly. **See “Preparing Your Files” on page 20.**

## I have a particular MP3 that won't play / plays badly / takes a long time to load / crashes the program.

The file may be damaged and may need to be deleted from your library. Please go to the forum at [serato.com](http://serato.com) and notify the support team that you have a bad file. By reporting damaged or corrupt files, you help the developers improve Scratch Live's ability to play damaged MP3 files in the future.

## Scratch Live freaks out when I use the master tempo (key correction) function on my CD player

Scratch Live interprets the signal coming out of the CD player, and uses this information to control the playback of the files on your computer. Any audio processing performed on the signal before it reaches the hardware interface, such as key correction, will scramble the signal

making it illegible to Scratch Live. Use key correction within Scratch Live instead.

**See “Key Lock” on page 23.**

## I want to backup my library and crates or move them to another machine, so where are they stored?

Your database and crates are stored in the folder Home\Music\\_Serato\_ on a Mac, and My Documents\My Music\\_Serato\_ in Windows XP, and Libraries\Music\\_Serato\_ in Windows 7. If your library contains tracks that are stored on a drive other than your boot drive, a folder called \_Serato\_ will be created in the root of that drive, and a separate database will be made in this folder. If it is a removable drive, the tracks will only appear in your library when the drive is connected. **See “Scratch Live Backup” on page 38.**

## I have pink files which don't play

These are files which Scratch Live thinks are missing. You can use the Relocate Lost Files feature in the Offline player to re-associate these with their new location. To do this you can: drag the file itself from Finder/Windows explorer onto the button to relocate an individual file, drag an entire folder onto this button, or press the button (this will search all connected drives for all the missing files in your library).

## Why are my hardware settings changing when i connect my laptop?

Settings are saved in the mixer. Software is updated with the mixer's settings. Therefore, the mixer may replace control source and effect settings in Scratch Live or software control panels with current mixer settings that may have been changed by a different laptop.

## What are the best cartridges to use with Scratch Live?

We recommend the Ortofon | Serato S-120 cartridges for use with Scratch Live. These employ revolutionary new cantilever suspension, which delivers high output volume, unrivaled tracking ability and low record wear.

**NOTE: To keep up with the latest tips, visit the [Official Scratch Live Forum](#).**

# Corrupt File Descriptions and Diagnoses

<b>Corrupt file: This MP3 contains invalid frames.</b>	This MP3 contains frames which do not conform strictly to the official MP3 specification. Scratch Live can not be certain that this file will play back 100% accurately.
<b>Corrupt file: This file contains corrupt frames that may result in audible glitches.</b>	This file contains two or more contiguous corrupt frames. Since corrupt frames are replaced with silence, this could result in what might sound like an audio glitch.
<b>Corrupt file: This file structure is incorrect.</b>	This file has caused the QuickTime metadata manager to fail.
<b>Corrupt file: This file has been split. You should check the beginning for audio glitches.</b>	The first MPEG audio frame in this file refers to audio that should be present before it but is not. This is usually the result of incorrect MP3 editing. Since a corrupt frame is replaced with silence and most songs start with silence, the resulting silence might not be noticeable. All the same, listen to the beginning of the song, just to be sure.
<b>Corrupt file: This MP3 contains frames with corrupt data.</b>	Decoding of an MPEG audio frame failed. This means that the frame contained invalid data. As usual with corrupt frames, this frame will be played as silence.
<b>Corrupt file: This MP3 lost synchronization between the frame index and the frames.</b>	Scratch Live is reading an old overview of an MP3 that has been edited in a third party editing program. Rebuilding the overviews for the affected files usually corrects this error.
<b>Corrupt file: This MP3 is completely invalid and is not playable.</b>	Self explanatory. Possible causes are disk bad sectors, file system corruption, wrong file types, wrong file extensions, etc.
<b>Corrupt file: This file contains invalid audio data.</b>	Scratch Live encountered invalid data while looking for audio in this file. This message alerts you to the fact that the file you're trying to play contains corrupt data. This may, or may not, affect playback.
<b>Corrupt file: This MP3 contains no valid frames.</b>	No audio could be found in this file, which means it is completely unplayable as far as Scratch Live is concerned. Please make sure this really is an audio file.
<b>Unsupported file: This MP3 contains multiple layers.</b>	While scanning this file, Scratch Live found frames belonging to multiple MPEG layers. Scratch Live does not support MP3s containing frames from multiple layers – some frames may output as silence.
<b>Unsupported file: This file is more than 2 GB in size.</b>	Self explanatory. At the moment, Scratch Live does not support files that are 2 GB in size (or larger).
<b>Unsupported file: This file has data blocks greater than 2 GB in size.</b>	This file contains chunks of data that are larger than 2 GB. Scratch Live does not support files that are more than 2 GB in size.
<b>Corrupt file: This WAV contains no valid chunks.</b>	This WAV file contains no recognizable WAV data. It is quite possible that this might not be a WAV file.
<b>Unsupported file: This file's data is not in PCM format.</b>	WAV files can contain data in several formats. Scratch Live only supports WAV files that contain data in the PCM format.
<b>Unsupported file: This file has a sampling rate greater than 96 kHz.</b>	Scratch Live does not support sampling rates greater than 96 kHz. If you see this message, the simplest approach is to re-sample the audio at 96 kHz and re-save the file.
<b>Unsupported file: This file uses more than 24 bits per sample.</b>	Scratch Live supports a maximum of 24 bits per sample of audio data.
<b>Corrupt file: This WAV is incomplete.</b>	Scratch Live expected more data in the file, but found none. This could be because the file was incorrectly truncated or because the data in the file is corrupt, causing Scratch Live to incorrectly estimate the amount of data present in the file.
<b>Corrupt file: This file contains corrupt blocks.</b>	This file contains blocks of data that report their size to be zero. This message was inserted to identify files that might cause lockups on previous versions of Scratch Live.
<b>Corrupt file: This song contains no audio data.</b>	Scratch Live could not find any audio in this file. Please check to make sure this file contains audio in a format that Scratch Live supports.
<b>Corrupt file: This song contains invalid samples.</b>	This file contains samples of audio that are too small to represent accurately and will therefore be truncated to zero. This should not result in any audible audio artifacts, but could cause audio dropouts on earlier versions of Scratch Live.

# Scope Reading and Fixes

Most of the problems that occur with Scratch Live can be attributed to it not getting a good reading of the control signal from your records or CDs. These examples show what the scopes on the setup screen can look like to help solve possible problems. Some problems cause similar looking scopes, e.g., if your scopes look like the Dusty Needle one, the cause could be a damaged needle.

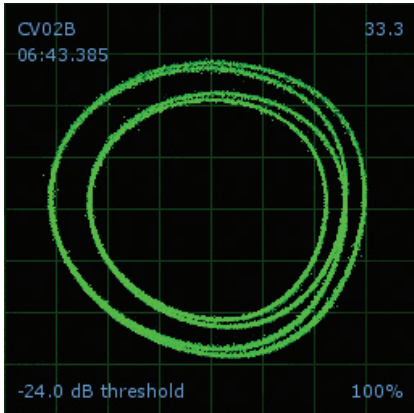

**GOOD SIGNAL** - Clean signal with 100% tracking.



**NO SIGNAL** - Scratch Live is not receiving any control signal - check your connections.

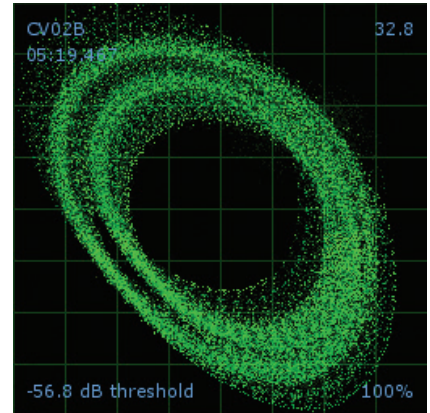

**BAD TURNTABLE VIBRATION** - Bass is reaching the stylus. Try to isolate the turntable from the speakers.



**CD PLAYER INTO PHONO INPUT** - The Sixty-Two is set to receive a phono level input. Switch to the correct setting on the mixer.

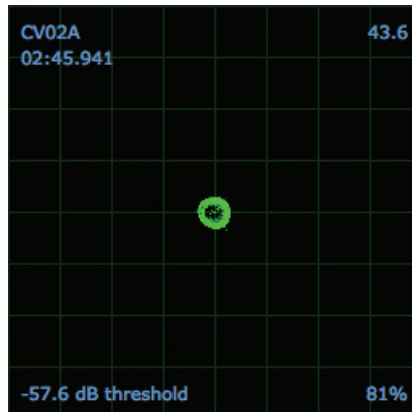

**PHONO INTO LINE INPUT** - The Sixty-Two is set to receive line level input. Switch to the correct setting on the mixer.

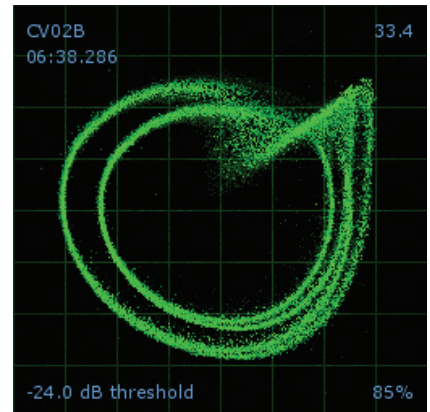

**DUSTY NEEDLE** - Dust is preventing the stylus from tracking the groove correctly. Clean your needle and the control vinyl.

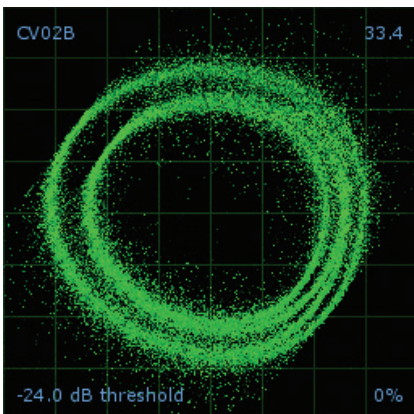

**UNEARTHED** - Very susceptible to interference. Attach the turntable's ground wire to the Sixty-Two.

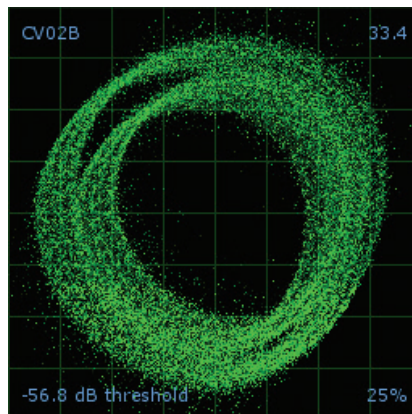

**USING PIGGYBACK CABLES** - Picking up huge amounts of noise, barely tracking. Check your cables.

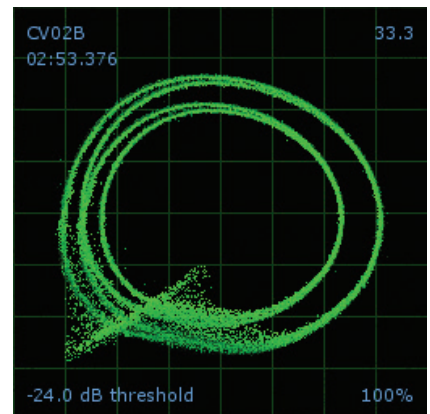

**DAMAGED NEEDLE** - Try re-seating, cleaning or replacing your stylus.



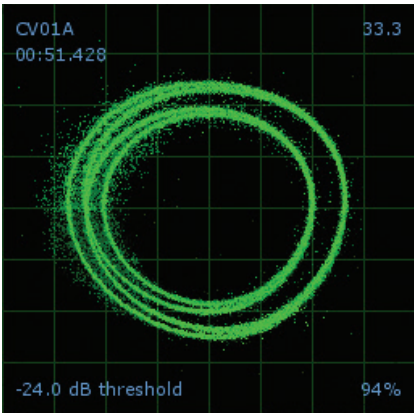

**RECORD BURN** - This section of the control vinyl has been worn. Swap sides or adjust the Vinyl Start Offset.

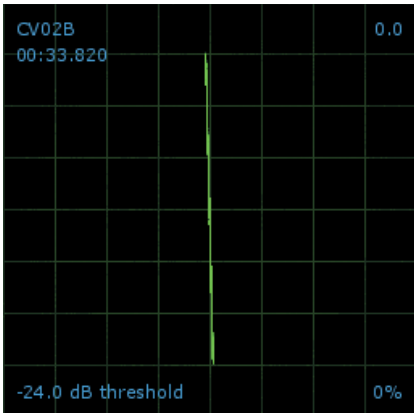

**LEFT CHANNEL MISSING** - The signal from the needle is not reaching the Sixty-Two. Check the cable and cartridge wiring.

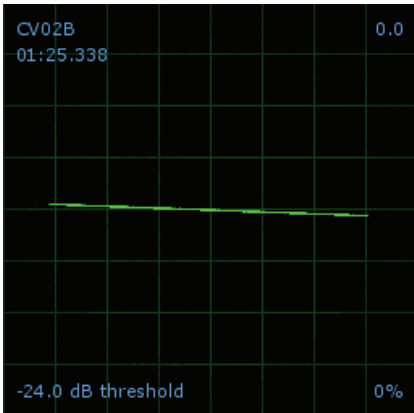

**RIGHT CHANNEL MISSING** - The signal from the needle is not reaching the Sixty-Two. Check the cable and cartridge wiring.

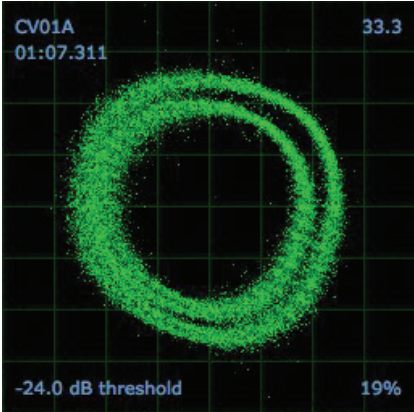

**BAD RECORD BURN** - Your record is worn and Scratch Live is unable to track correctly. Swap sides or get new vinyl ASAP.

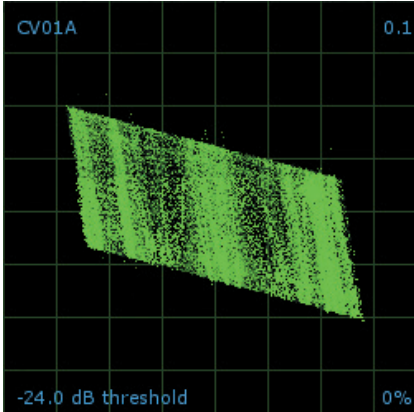

**LEFT CHANNEL IS NOISE** - Left signal has been lost with a noisy loose connection.

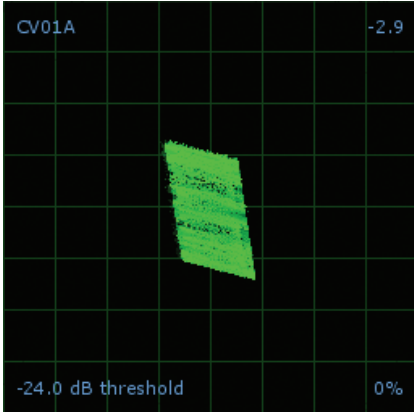

**RIGHT CHANNEL IS NOISE** - Right signal has been lost with a noisy loose connection.

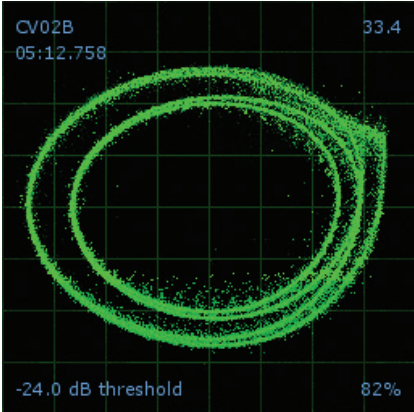

**TONEARM IS SLIGHTLY TOO LIGHT** - Susceptible to dust and vibration. Adjust the tonearm.

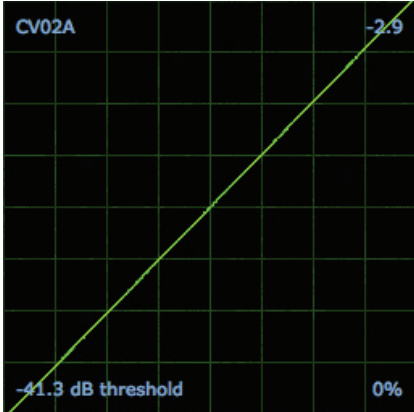

**SIGNALS ARE SUMMING TO MONO** - The left and right signals have been combined into one somewhere in your signal chain.

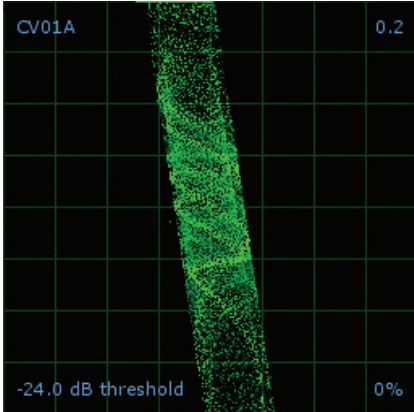

**RIGHT CHANNEL IS INTERFERENCE** - Right signal has been lost with a noisy loose connection and left channel crosstalk.

# Appendix

Sixty-Two Specifications	All specifications typical unless otherwise stated
Analog Inputs	4 Stereo unbalanced RCA jacks
.....Phono or Line level input	Rear panel switches for each input
.....Phono Response	RIAA $\pm 1$ dB, Gain: 31 dB at 1 kHz
.....Max Phono Input	126 mV
.....Max Line Input	4 Vrms
ADCs	24-bit, 48 kHz; Dynamic range 101 dB A-weighted
DACs	24-bit, 48 kHz; Dynamic range 107 dB A-weighted
Digital Signal Processing	48 kHz, 32-bit floating point
USB Audio	Six Stereo Record, Four Stereo Playback
.....	48 kHz, 32-bit floating point
FlexFX Return	Stereo unbalanced 1/4" TS (tip-sleeve) phone jack
FlexFX Send	Stereo unbalanced 1/4" TS phone jack
Mic Input	Balanced 1/4" TRS & XLR combination jack
.....Tone Controls	2-band, High and Low
.....Mic-Line level switch	Choose Line to connect wireless receiver
Line Outputs: Frequency Response	20 Hz to 20 kHz $\pm 0.25$ dB, Line in to Line out
.....THD+N	<0.01% re 0 dBFS, 20 to 20 kHz, 20 kHz BW
.....Unbalanced jacks (RCA & FlexFX)	Maximum 4 Vrms
.....Balanced jacks (Main & Booth)	Maximum 8 Vrms
Universal Power Supply	100 to 240 VAC, 50 Hz to 60 Hz, 15 W max
USB Power	Mixer is self-powered
Unit Size	14.25" x 10.5" x 4" (36.2 cm x 26.7 cm x 10.2 cm)
.....Weight	10 lb (4.3 kg)
Shipping Size	7.75" H x 15" W x 19.25" D (19.7 cm x 38.1 cm x 49 cm)
.....Weight	14 lb (6.4 kg)

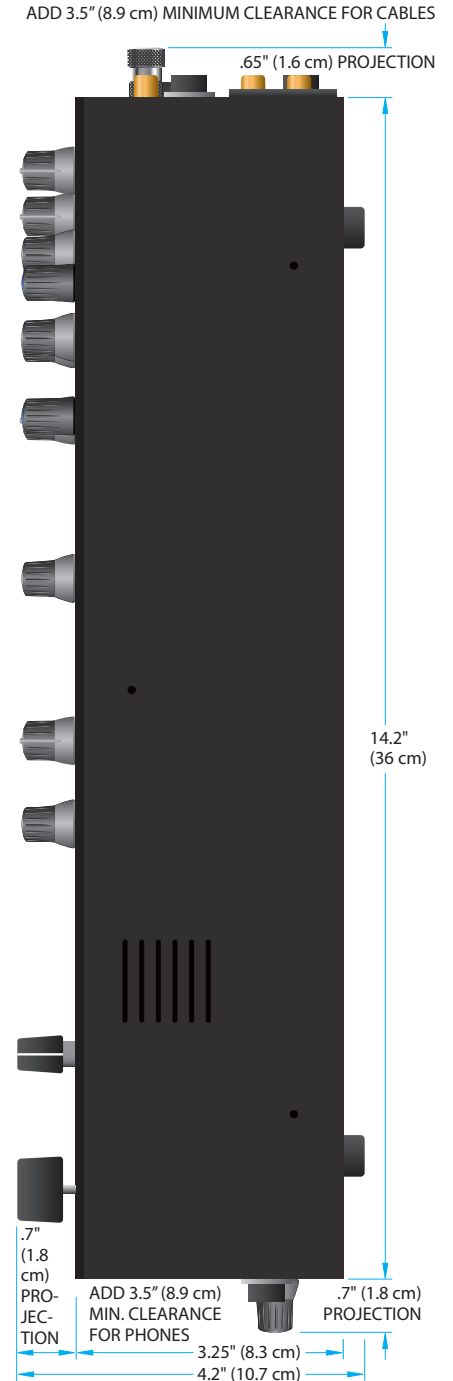

**Battle Bridge Accessory**

When installing a Sixty-Two mixer in a coffin case, it is important to leave 10 centimeters (3.9 inches) in front and in back of the mixer to allow room for cables and access to controls. The rubber feet provided on the chassis for table top use should remain in place when installing the mixer in a coffin case. When in operation, the coffin case must provide 1 centimeter

(0.39 inches) clearance on each side of the mixer and above the controls on the face of the mixer.

A battle bridge kit is available for the Sixty-Two Mixer (also fits the Sixty-Eight). The brackets install easily with three screws on each side. These are powder-coated electro-galvanized .075" steel.

**14" EARS** bring the total width of the mixer to 30.5 cm (12") for coffin mounting. These measure 35.8 x 1.9 x 7.7 cm (14" x .75" x 3"). Shipping weight is 1.36 kg (3 pounds).

If you live in the U.S.A., you may buy these ears in the Rane Factory Store at [dj.rane.com](http://dj.rane.com). Outside the U.S.A., contact your international representative – contacts are at [dj.rane.com](http://dj.rane.com).

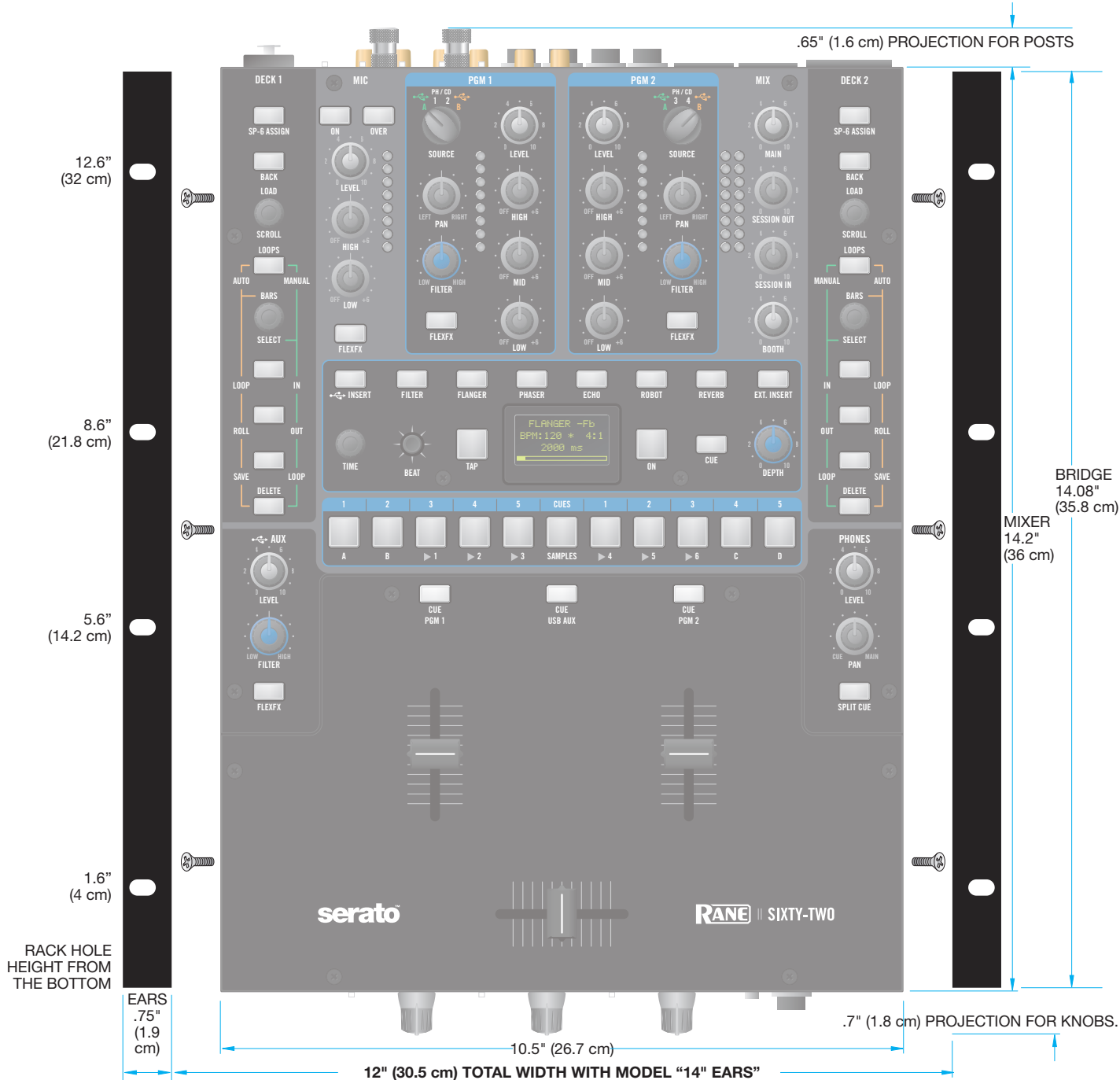

## Magnetic Fader Maintenance

The faders and crossfader in the Sixty-Two are designed with materials highly resistant to corrosion and most chemicals. While they will handle millions of operations, they may become dirty over time. Bad things may be spilled into a fader, but in many instances the fader may not be damaged and the sound quality thus unaffected. Cleaning is only required to maintain the feel of the fader.

In order to maintain the feel of your faders, they may occasionally require cleaning and lubrication. The bearings in the fader work best with DuPont Teflon Multi-use Lubricant (part # D00040101). Make sure to follow the instructions and warnings on the bottle.

This lubricant goes on wet to deeply penetrate moving parts, but sets up with a clean, dry, long-lasting film which will not attract and absorb dirt and grime. Wet or oily lubricants may feel good at first, but will attract dirt and evaporate or become dry over time. See the fader cleaning instructions below.

## Fader Assembly Removal

1. Remove all three fader knobs.
2. Remove all six screws holding the fader panel face plate.
3. Lift up the fader panel face plate and set it aside where it can't get damaged.
4. Remove the two screws at each end of a fader, holding the bottom of the fader in place with your other hand.
5. Take out the fader assembly completely.
6. Note the left connector goes to the left fader, the center connector goes to the crossfader, and the right connector goes to the right fader.
7. Unplug the connectors of the white wires at the fader assembly without pulling the wires.

Reverse this procedure to re-assemble.

- Plug in the connector before re-installing the fader. Note the connector only will fit one way.
- Test all the faders before installing the fader panel face plate and fader knobs.

## Fader Cleaning

1. For a light cleaning, move the carrier to one side and wipe rails with a lint-free cloth. Move the carrier to the other side and repeat.
2. If a heavier cleaning is required to remove oily lubricants or grease, first take the carrier off of the rails by removing one of the endblocks. Clean the rails using a lint-free cloth and alcohol. Use a cue-tip and alcohol to clean the carrier bearings.
3. With the fader clean, dry and assembled, add a couple of drops of Teflon Multi-use Lubricant to each rail of the fader.
4. Move the carrier back and forth to distribute lubricant.
5. Do not disturb the position of the small sensors at each end of the fader. If you accidentally do, make sure the parts are standing straight before re-installing.

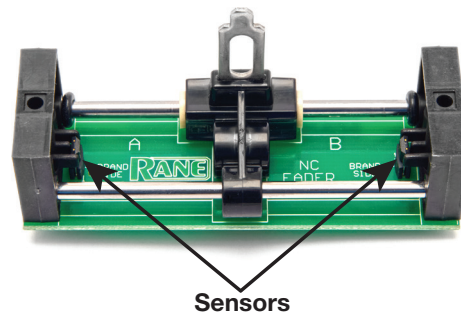

## Fader Calibration

After cleaning or replacement, the sensors may get moved, affecting the contour. After any fader service, perform this procedure to re-calibrate the faders and crossfader.

1. Power off the Sixty-Two.
2. Move all faders to the center-most position.
3. Push down both **PGM 1 CUE** and **PGM 2 CUE** buttons at the same time.
4. While holding these buttons down, power on the Sixty-Two.
5. Immediately after fading up, the **CUE** lights will flash one time, indicating a successful calibration. If the **CUE** lights flash three times, the sensors may have moved too far or all faders were not properly centered, and the faders cannot correctly calibrate.

**Problems?** Contact Rane Corporation customer service at 425-355-6000 or email us at [info@rane.com](mailto:info@rane.com). Online help is available at [serato.com](http://serato.com).

## MIDI Implementation

Scratch Live MIDI Control only supports:

- Note On/Off
- Standard 7-bit CC (Control Change)

### MIDI Note ON/OFF Chart

The note number for an LED indicator under a button is the same as for the button.

The color and brightness of an LED is determined by the velocity as follows:

- 0-30                    0x00-0x1E            Off
- 31-47                0x1F-0x2F            Primary Dim
- 48-78                0x30-0x4E            Primary Full
- 79-95                0x4F-0x5F            Secondary Dim
- 96-127                0x60-0x7F            Secondary Full

There are two categories of note on/off MIDI controls:

**RED:** Dedicated mixer controls are read only and not affected by MIDI in commands. A user is not able to control mixer functions via MIDI and is unable to change the color or intensity of an LED under one of these mixer controls. Users are able to use MIDI out for these controls to trigger or control software functions.

**GREEN:** MIDI controls on the mixer dedicated to Scratch Live or 3rd-party DAW control. These controls are read/write and a user is able to control the color and intensity of LEDs under these buttons.

Note #	Hex #	Function	LED States		Type
0	0x00	FlexFX On	Not Permitted		Mixer Control
2	0x02	FX Time Encoder Push	Not Applicable		Mixer Control
4	0x04	FlexFX Cue	Not Permitted		Mixer Control
5	0x05	FX Tap	Not Permitted		Mixer Control
7	0x07	Beat Joystick Push	Not Applicable		Mixer Control
8	0x08	Reverb	Not Permitted		Mixer Control
9	0x09	Robot	Not Permitted		Mixer Control
10	0x0A	Phaser	Not Permitted		Mixer Control
11	0x0B	Flanger	Not Permitted		Mixer Control
12	0x0C	Filter	Not Permitted		Mixer Control
13	0x0D	Echo	Not Permitted		Mixer Control
18	0x12	LH Cue-1	PRI – Green	SEC – Yellow	DAW MIDI Control
19	0x13	LH Delete	PRI – Red	SEC - Orange	DAW MIDI Control
20	0x14	LH Cue-5	PRI – Green	SEC – Yellow	DAW MIDI Control
21	0x15	LH Cue-4	PRI – Green	SEC – Yellow	DAW MIDI Control
22	0x16	LH Cue-3	PRI – Green	SEC – Yellow	DAW MIDI Control
23	0x17	LH Cue-2	PRI – Green	SEC – Yellow	DAW MIDI Control
24	0x18	USB AUX FlexFX	Not Permitted		Mixer Control
25	0x19	LH Manual Loop Select Encoder Push	Not Applicable		DAW MIDI Control
28	0x1C	LH Manual Loop In	PRI – Green	SEC – Orange	DAW MIDI Control
29	0x1D	LH Manual Loop	PRI – Green	SEC – Orange	DAW MIDI Control
30	0x1E	LH Manual Out	PRI – Green	SEC – Orange	DAW MIDI Control
31	0x1F	USB Insert	Not Permitted		Mixer Control
34	0x22	Mic FlexFX	Not Permitted		Mixer Control
41	0x29	Mic ON	Not Permitted		Mixer Control

42	0x2A	LH SP-6 Assign	Not Permitted		Mixer Control
43	0x2B	LH Back	PRI – Green	SEC – Orange	DAW MIDI Control
44	0x2C	LH Scroll Encoder Push	Not Applicable		DAW MIDI Control
45	0x2D	LH Manual/Auto Loop	Not Permitted		Mixer Control
46	0x2E	Mic Talk-over	Not Permitted		Mixer Control
50	0x32	SR Manual/Auto Loop	Not Permitted		Mixer Control
51	0x33	SR SP-6 Assign	Not Permitted		Mixer Control
52	0x34	RH Back	PRI – Green	SEC – Orange	DAW MIDI Control
55	0x37	RH Scroll Encoder Push	Not Applicable		DAW MIDI Control
56	0x38	Split Cue	Not Permitted		Mixer Control
57	0x39	RH Manual Loop	PRI – Green	SEC – Orange	DAW MIDI Control
58	0x3A	RH Manual Loop Select Encoder Push	Not Applicable		DAW MIDI Control
61	0x3D	RH Manual Out	PRI – Green	SEC – Orange	DAW MIDI Control
63	0x3F	RH Manual In	PRI – Green	SEC – Orange	DAW MIDI Control
67	0x43	PGM 2 FlexFX	Not Permitted		Mixer Control
68	0x44	PGM 1 FlexFX	Not Permitted		Mixer Control
69	0x45	PGM 1 Cue	Not Permitted		Mixer Control
70	0x46	PGM 2 Cue	Not Permitted		Mixer Control
73	0x49	RH Cue-2	PRI – Green	SEC – Yellow	DAW MIDI Control
74	0x4A	RH Cue-3	PRI – Green	SEC – Yellow	DAW MIDI Control
75	0x4B	RH Cue-4	PRI – Green	SEC – Yellow	DAW MIDI Control
76	0x4C	RH Cue-5	PRI – Green	SEC – Yellow	DAW MIDI Control
77	0x4D	USB Aux Cue	Not Permitted		Mixer Control
78	0x4E	RH Cue-1	PRI – Green	SEC – Yellow	DAW MIDI Control
79	0x4F	RH Delete	PRI – Red	SEC - Orange	DAW MIDI Control
90	0x5A	Cues/Samples	Not Permitted		Mixer Control
91	0x5B	Ext Insert	Not Permitted		Mixer Control
98	0x62	Sample-1	PRI – Green	SEC – Yellow	DAW MIDI Control
99	0x63	Sample-2	PRI – Green	SEC – Yellow	DAW MIDI Control
100	0x64	Sample-3	PRI – Green	SEC – Yellow	DAW MIDI Control
101	0x65	Sample-4	PRI – Green	SEC – Yellow	DAW MIDI Control
102	0x66	Sample-5	PRI – Green	SEC – Yellow	DAW MIDI Control
103	0x67	Sample-6	PRI – Green	SEC – Yellow	DAW MIDI Control
104	0x68	Bank A	PRI – Green	SEC – Yellow	DAW MIDI Control
105	0x69	Bank B	PRI – Green	SEC – Yellow	DAW MIDI Control
106	0x6A	Bank C	PRI – Green	SEC – Yellow	DAW MIDI Control
107	0x6B	Bank D	PRI – Green	SEC – Yellow	DAW MIDI Control
108	0x6C	LH Auto Loop Select Encoder Push	Not Applicable		DAW MIDI Control
109	0x6D	LH Auto Loop	PRI – Green	SEC – Orange	DAW MIDI Control
110	0x6E	LH Auto Roll	PRI – Green	SEC – Orange	DAW MIDI Control
111	0x6F	LH Auto Save	PRI – Green	SEC – Orange	DAW MIDI Control
112	0x70	RH Auto Loop Select Encoder Push	Not Applicable		DAW MIDI Control
113	0x71	RH Auto Loop	PRI – Green	SEC – Orange	DAW MIDI Control
114	0x72	RH Auto Roll	PRI – Green	SEC – Orange	DAW MIDI Control
115	0x73	RH Auto Save	PRI – Green	SEC – Orange	DAW MIDI Control

## MIDI Control Change Chart

Functions highlighted in **RED** are MIDI-Out Mixer controls.

Functions highlighted in **BLUE** are MIDI-In mixer controls.

Functions highlighted in **GREEN** are MIDI-Out Scratch Live or 3rd-party DAW controls.

Control #	Hex #	Function	Values																																																																				
0	0x00	Crossfader	0-127, 0x00-0x7F																																																																				
1	0x01	FX Depth	0-127, 0x00-0x7F																																																																				
2	0x02	PGM 1 Contour	0-127, 0x00-0x7F																																																																				
3	0x03	PGM 2 Contour	0-127, 0x00-0x7F																																																																				
4	0x04	PGM 1 Left-Right Pan	0-127, 0x00-0x7F																																																																				
5	0x05	PGM 2 Left-Right Pan	0-127, 0x00-0x7F																																																																				
7	0x07	USB Aux Level	0-127, 0x00-0x7F																																																																				
8	0x08	USB Aux Filter	0-127, 0x00-0x7F																																																																				
16	0x10	LH Scroll Encoder	2's Complement from 64 / Relative (Binary Offset)																																																																				
17	0x11	LH Manual Loop Select Encoder	2's Complement from 64 / Relative (Binary Offset)																																																																				
18	0x12	RH Scroll Encoder	2's Complement from 64 / Relative (Binary Offset)																																																																				
19	0x13	RH Manual Loop Select Encoder	2's Complement from 64 / Relative (Binary Offset)																																																																				
20	0x14	FX Time Encoder	2's Complement from 64 / Relative (Binary Offset)																																																																				
21	0x15	Analog 1 Phono Sensitivity	<table border="1"> <thead> <tr> <th>Value</th> <th>Hex</th> <th>Sensitivity (mV)</th> <th>dB</th> </tr> </thead> <tbody> <tr><td>0</td><td>0x00</td><td>2.5</td><td>16.04</td></tr> <tr><td>1</td><td>0x01</td><td>3</td><td>14.46</td></tr> <tr><td>2</td><td>0x02</td><td>3.5</td><td>12.12</td></tr> <tr><td>3</td><td>0x03</td><td>4</td><td>11.96</td></tr> <tr><td>4</td><td>0x04</td><td>4.5</td><td>10.94</td></tr> <tr><td>5</td><td>0x05</td><td>5 (Default)</td><td>10.02</td></tr> <tr><td>6</td><td>0x06</td><td>5.5</td><td>9.19</td></tr> <tr><td>7</td><td>0x07</td><td>6</td><td>8.44</td></tr> <tr><td>8</td><td>0x08</td><td>6.5</td><td>7.74</td></tr> <tr><td>9</td><td>0x09</td><td>7</td><td>7.10</td></tr> <tr><td>10</td><td>0x0A</td><td>7.5</td><td>6.5</td></tr> <tr><td>11</td><td>0x0B</td><td>8</td><td>5.94</td></tr> <tr><td>12</td><td>0x0C</td><td>8.5</td><td>5.41</td></tr> <tr><td>13</td><td>0x0D</td><td>9</td><td>4.92</td></tr> <tr><td>14</td><td>0x0E</td><td>9.5</td><td>4.45</td></tr> <tr><td>15</td><td>0x0F</td><td>10</td><td>4.00</td></tr> </tbody> </table>	Value	Hex	Sensitivity (mV)	dB	0	0x00	2.5	16.04	1	0x01	3	14.46	2	0x02	3.5	12.12	3	0x03	4	11.96	4	0x04	4.5	10.94	5	0x05	5 (Default)	10.02	6	0x06	5.5	9.19	7	0x07	6	8.44	8	0x08	6.5	7.74	9	0x09	7	7.10	10	0x0A	7.5	6.5	11	0x0B	8	5.94	12	0x0C	8.5	5.41	13	0x0D	9	4.92	14	0x0E	9.5	4.45	15	0x0F	10	4.00
Value	Hex	Sensitivity (mV)	dB																																																																				
0	0x00	2.5	16.04																																																																				
1	0x01	3	14.46																																																																				
2	0x02	3.5	12.12																																																																				
3	0x03	4	11.96																																																																				
4	0x04	4.5	10.94																																																																				
5	0x05	5 (Default)	10.02																																																																				
6	0x06	5.5	9.19																																																																				
7	0x07	6	8.44																																																																				
8	0x08	6.5	7.74																																																																				
9	0x09	7	7.10																																																																				
10	0x0A	7.5	6.5																																																																				
11	0x0B	8	5.94																																																																				
12	0x0C	8.5	5.41																																																																				
13	0x0D	9	4.92																																																																				
14	0x0E	9.5	4.45																																																																				
15	0x0F	10	4.00																																																																				
22	0x16	PGM 1 Filter Resonance	0-127, 0x00-0x7F Low to High Resonance																																																																				
23	0x17	PGM 1 Input Record Source (USB 5-6)	1 0x01 Record A1 2 0x02 Record A2																																																																				
24	0x18	Analog 2 Phono Sensitivity	Same as Analog 1 Phono Sensitivity																																																																				
25	0x19	PGM 2 Filter Resonance	0-127, 0x00-0x7F Low to High Resonance																																																																				
26	0x1A	PGM 2 Input Record Source (USB 7-8)	1 0x01 Record A3 2 0x02 Record A4																																																																				
27	0x1B	Analog 3 Phono Sensitivity	Same as Analog 1 Phono Sensitivity																																																																				
30	0x1E	Analog 4 Phono Sensitivity	Same as Analog 1 Phono Sensitivity																																																																				
33	0x21	Main Record Select, (USB 11-12)	1 0x01 Record Main Mix 2 0x02 Record Mic																																																																				
38	0x26	USB Aux Filter Resonance	0-127, 0x00-0x7F Low to High Resonance																																																																				
39	0x27	FX Flanger Type	0-63, 0x00-0x3F Negative 64-127 0x40-0x7F Positive																																																																				

40	0x28	FX Echo Type	0-31 32-63 64-95 96-127	0x00-0x1F 0x20-0x3F 0x40-0x5F 0x60-0x7F	Echo High-Pass Echo Hold Echo HP Hold Echo
41	0x29	FX Filter Type	0-31, 32-63, 64-95, 96-127	0x00-0x1F 0x20-0x3F 0x40-0x5F 0x60-0x7F	Low-Pass Sync Low Low-Pass Sync High High-Pass Sync Low High-Pass Sync High
42	0x2A	Echo HP Frequency	0-127	0x00-0x7F	20 Hz-10 kHz, Uniform Octave Steps
43	0x2B	Hold Echo HP Frequency	0-127	0x00-0x7F	20 Hz-10 kHz, Uniform Octave Steps
44	0x2C	LH Auto Loop Bars Encoder	2's Complement from 64 / Relative (Binary Offset)		
45	0x2D	RH Auto Loop Bars Encoder	2's Complement from 64 / Relative (Binary Offset)		
65	0x41	PGM 1 LP/HP Filter	0-127	0x00-0x7F	
66	0x42	PGM 2 LP/HP Filter	0-127	0x00-0x7F	
69	0x45	Session In Level	0-127	0x00-0x7F	
71	0x47	PGM 1 Low	0-127	0x00-0x7F	
72	0x48	PGM 2 Low	0-127	0x00-0x7F	
75	0x4B	Booth Level	0-127	0x00-0x7F	
77	0x4D	PGM 1 Mid	0-127	0x00-0x7F	
78	0x4E	PGM 2 Mid	0-127	0x00-0x7F	
82	0x52	Mic Low	0-127	0x00-0x7F	
83	0x53	PGM 1 Fader	0-127	0x00-0x7F	
84	0x54	PGM 2 Fader	0-127	0x00-0x7F	
87	0x57	Session Out Level	0-127	0x00-0x7F	
89	0x59	PGM 1 Level	0-127	0x00-0x7F	
90	0x5A	PGM 2 Level	0-127	0x00-0x7F	
93	0x5D	Main Level	0-127	0x00-0x7F	
94	0x5E	Mic High	0-127	0x00-0x7F	
98	0x62	Crossfader Contour	0-127	0x00-0x7F	
99	0x63	Phones Level	0-127	0x00-0x7F	
100	0x64	Mic Level	0-127	0x00-0x7F	
101	0x65	PGM 1 High	0-127	0x00-0x7F	
102	0x66	PGM 2 High	0-127	0x00-0x7F	
105	0x69	Headphone Cue / Main Pan	0-127	0x00-0x7F	
106	0x6A	Crossfader Reverse	0 – Normal, 1 – Reversed	0x00 – Normal, 0x01 – Reversed	
107	0x6B	PGM 1 Reverse	0 – Normal, 1 – Reversed	0x00 – Normal, 0x01 – Reversed	
108	0x6C	PGM 2 Reverse	0 – Normal, 1 – Reversed	0x00 – Normal, 0x01 – Reversed	
111	0x6F	FX Beat Joystick	0-120	0x00-0x78	(0 = is 12:00 o'clock, value increments by 8 moving clockwise)
112	0x70	PH/CD 1 Select	0 – Phono, 1 – Line	0x00 – Phono, 0x01 – Line	
113	0x71	PH/CD 2 Select	0 – Phono, 1 – Line	0x00 – Phono, 0x01 – Line	
114	0x72	PH/CD 3 Select	0 – Phono, 1 – Line	0x00 – Phono, 0x01 – Line	
115	0x73	PH/CD 4 Select	0 – Phono, 1 – Line	0x00 – Phono, 0x01 – Line	
116	0x74	PGM 1 Source Select	1 2 3 4	0x01 0x02 0x03 0x04	USB A Left Virtual Deck, Analog 1 Analog 2 USB B Left Virtual Deck
117	0x75	PGM 2 Source Select	1 2 3 4	0x01 0x02 0x03 0x04	USB A Right Virtual Deck Analog 3, Analog 4 USB B Right Virtual Deck



# Declaration of Conformity

**Application of**

**Council Directives:**

2001/95/EC      2002/96/EC  
 2004/108/EC    2006/95/EC  
 2011/65/EU

**Standard(s) to which  
 conformity is declared:**

EN60065:2002/A1:2006/A11:2008  
 EN55103-1:2009  
 EN55103-2:2009  
 EN50581:2012  
 ENVIRONMENT E2  
 SERIAL NUMBERS 850000 - 950000  
 CE MARK FIRST AFFIXED IN: 2012

**Manufacturer:**

**Rane Corporation**  
**10802 47th Avenue West**  
**Mukilteo WA 98275-5000 USA**

This equipment has been tested and found to be in compliance with all applicable standards and regulations applying to the EU's Low Voltage (LV) directive 2006/95/EC and Electromagnetic Compatibility (EMC) directive, 2004/108/EC. In order for the customer to maintain compliance with this regulation, high quality shielded cable must be used for interconnection to other equipment. Modification of the equipment, other than that expressly outlined by the manufacturer, is not allowed under this directive. The user of this equipment shall accept full responsibility for compliance with the LV directive and the EMC directive in the event that the equipment is modified without written consent of the manufacturer. This declaration of conformity is issued under the sole responsibility of Rane Corporation.

**Type of Equipment:** Professional Audio Signal Processing

**BRAND:** Rane

**Model:** Sixty-Two

Immunity Results:      THD+N: 4 dBu, 400 Hz, BW 20 Hz - 20 kHz

**Test Description      Measurement      Conditions**

**RF Electromagnetic Fields Immunity**

80 MHz -1000 MHz, 1 kHz AM, 80% depth, 3V/m      <-72 dB  
 1400 MHz - 2700 MHz, 1 kHz AM, 80% depth, 3V/m      <-72 dB

**Conducted RF Disturbances Immunity**

150 kHz - 80 MHz, 1 kHz AM, 80% depth, 3V rms      <-71 dB

**Magnetic Fields Immunity**

50 Hz - 10 kHz, 3.0 - 0.3 A/m      <-75 dB

**Common Mode Immunity (Signal Ports)**

50 Hz - 10 kHz, -20 dBu      <-69 dB      Bandpass re: 4 dBu, 1/3-octave

*I, the undersigned, hereby declare that the equipment specified above conforms to the Directive(s) and Standard(s) shown above.*

  
 \_\_\_\_\_  
 (Signature)

**Greg Frederick**  
 \_\_\_\_\_  
 (Full Name)

**Compliance Engineer**  
 \_\_\_\_\_  
 (Position)

**January 25, 2012**  
 \_\_\_\_\_  
 (Date)

**Mukilteo WA USA**  
 \_\_\_\_\_  
 (Place)

# Limited Warranties

## Factory Authorized Service

Your unit may someday need to be serviced by the Rane Factory if you live in the USA. International customers should contact your dealer or distributor for service. You must call the Rane factory before shipping. Please do not return your unit to Rane without prior authorization.

Rane Corporation

To obtain service or a Return Authorization in the USA, please phone 425-355-6000  
or Fax 425-347-7757

## Limited U.S.A. Warranty

RANE CORPORATION WARRANTS ALL RANE PRODUCTS (EXCEPT THOSE ITEMS CLASSIFIED AS *WEAR PARTS*, AND LISTED ON THE MANUAL-1 PAGE OF EACH OPERATORS MANUAL) PURCHASED IN THE U.S. AGAINST DEFECTS IN MATERIAL OR WORKMANSHIP FOR A PERIOD OF TWO (2) YEARS. *WEAR PARTS* ARE LIMITED TO A PERIOD OF NINETY (90) DAYS FROM THE INITIAL DATE OF RETAIL PURCHASE FROM AN AUTHORIZED RANE DEALER—*WEAR PARTS* REQUIRE PROOF OF PURCHASE DATE. This limited warranty extends to all purchasers or owners of the product during the warranty period beginning with the original retail purchase. Rane Corporation does not, however, warrant its products against any and all defects: 1) arising out of material or workmanship not provided or furnished by Rane, or 2) resulting from abnormal use of the product or use in violation of instructions, or 3) in products repaired or serviced by other than the Rane Factory, or 4) in products with removed or defaced serial numbers, or 5) in components or parts or products expressly warranted by another manufacturer. Rane agrees to supply all parts and labor to repair or replace defects covered by this limited warranty with parts or products of original or improved design, at its option in each respect, if the defective product is shipped prior to the end of the warranty period to the Rane Factory in the original packaging or a replacement supplied by Rane, with all transportation costs and full insurance paid each way by the purchaser or owner.

## Limited Warranty Outside the U.S.A.

RANE PRODUCTS ARE WARRANTED ONLY IN THE COUNTRY WHERE PURCHASED, THROUGH THE AUTHORIZED RANE DISTRIBUTOR IN THAT COUNTRY, AGAINST DEFECTS IN MATERIAL OR WORKMANSHIP, THE SPECIFIC PERIOD OF THIS LIMITED WARRANTY SHALL BE THAT WHICH IS DESCRIBED TO THE ORIGINAL RETAIL PURCHASER BY THE AUTHORIZED RANE DEALER OR DISTRIBUTOR AT THE TIME OF PURCHASE. Rane Corporation does not, however, warrant its products against any and all defects: 1) arising out of materials or workmanship not provided or furnished by Rane, or 2) resulting from abnormal use of the product or use in violation of instructions, or 3) in products repaired or serviced by other than authorized Rane repair facilities, or 4) in products with removed or defaced serial numbers, or 5) in components or parts or products expressly warranted by another manufacturer. Rane agrees, through the applicable authorized distributor, to repair or replace defects covered by this limited warranty with parts or products of original or improved design, at its option in each respect, if the defective product is shipped prior to the end of the warranty period to the designated authorized Rane warranty repair facility in the country where purchased, or to the Rane factory in the U.S., in the original packaging or a replacement supplied by Rane, with all transportation costs and full insurance paid each way by the purchaser or owner.

ALL REMEDIES AND THE MEASURE OF DAMAGES ARE LIMITED TO THE ABOVE SERVICES, IT IS POSSIBLE THAT ECONOMIC LOSS OR INJURY TO PERSON OR PROPERTY MAY RESULT FROM THE FAILURE OF THE PRODUCT; HOWEVER, EVEN IF RANE HAS BEEN ADVISED OF THIS POSSIBILITY, THIS LIMITED WARRANTY DOES NOT COVER ANY SUCH CONSEQUENTIAL OR INCIDENTAL DAMAGES. SOME STATES OR COUNTRIES DO NOT ALLOW THE LIMITATIONS OR EXCLUSION OF INCIDENTAL OR CONSEQUENTIAL DAMAGES, SO THE ABOVE LIMITATION MAY NOT APPLY TO YOU.

ANY AND ALL WARRANTIES, EXPRESS OR IMPLIED, ARISING BY LAW, COURSE OF DEALING, COURSE OF PERFORMANCE, USAGE OF TRADE, OR OTHERWISE, INCLUDING BUT NOT LIMITED TO IMPLIED WARRANTIES OF MERCHANTABILITY AND FITNESS FOR A PARTICULAR PURPOSE, ARE LIMITED TO A PERIOD OF TWO (2) YEARS FROM EITHER THE DATE OF ORIGINAL RETAIL PURCHASE OR, IN THE EVENT NO PROOF OF PURCHASE DATE IS AVAILABLE, THE DATE OF MANUFACTURE, SOME STATES OR COUNTRIES DO NOT ALLOW LIMITATIONS ON HOW LONG AN IMPLIED WARRANTY LASTS, SO THE ABOVE LIMITATIONS MAY NOT APPLY TO YOU. THIS LIMITED WARRANTY GIVES YOU SPECIFIC LEGAL RIGHTS, AND YOU MAY ALSO HAVE OTHER RIGHTS WHICH VARY FROM STATE TO STATE, COUNTRY TO COUNTRY.

## Warranty Procedure - Valid in U.S.A. only

**NOTICE! You must complete and return the warranty card or register your product online to extend the Warranty from 2 years to 3 years!**

TO VALIDATE YOUR EXTENDED WARRANTY: Use the postcard that came in the box with your unit, or go to **product registration** under **support** at **dj.rane.com**. Fill out the warranty completely, being sure to include the model and serial number of the unit since this is how warranties are tracked. If your Rane product was purchased in the U.S.A., mail the completed card or register online with to Rane Corporation within 10 days from the date of purchase. **If you purchased the product outside the U.S.A. you must file your warranty registration with the Rane Distributor in that country.** It is advised that you keep your bill of sale as proof of purchase, should any difficulties arise concerning the registration of the warranty card. **NOTICE: IT IS NOT NECESSARY TO REGISTER IN ORDER TO RECEIVE RANE CORPORATION'S STANDARD TWO YEAR LIMITED WARRANTY.**

WARRANTY REGISTRATION is made and tracked by MODEL AND SERIAL NUMBERS ONLY, not by the purchaser's or owner's name. Therefore any warranty correspondence or inquires **MUST** include the model and serial number of the product in question. Be sure to fill in the model and serial number in the space provided below and keep this in a safe place for future reference.

WARRANTY SERVICE **MUST BE PERFORMED ONLY BY AN AUTHORIZED RANE SERVICE FACILITY LOCATED IN THE COUNTRY WHERE THE UNIT WAS PURCHASED, OR (if product was purchased in the U.S.) AT THE RANE FACTORY IN THE U.S..** If the product is being sent to Rane for repair, please call the factory for a Return Authorization number. We recommend advance notice be given to the repair facility to avoid possible needless shipment in case the problem can be solved over the phone. **UNAUTHORIZED SERVICE PERFORMED ON ANY RANE PRODUCT WILL VOID ITS EXISTING FACTORY WARRANTY.**

FACTORY SERVICE: If you wish your Rane product to be serviced at the factory, it must be shipped **FULLY INSURED, IN THE ORIGINAL PACKING OR EQUIVALENT.** This warranty will **NOT** cover repairs on products damaged through improper packaging. If possible, avoid sending products through the mail. Be sure to include in the package:

1. Complete return street shipping address (P.O. Box numbers are **NOT** acceptable).
2. A detailed description of any problems experienced, including the make and model numbers of any other system equipment.

Repaired products purchased in the U.S. will be returned prepaid freight via the same method they were sent to Rane. Products purchased in the U.S., but sent to the factory from outside the U.S. **MUST** include return freight funds, and the sender is fully responsible for all customs procedures, duties, tariffs and deposits.

**In order to qualify for Rane's one year extended warranty (for a total of 3 years parts and labor), the warranty must be completely filled out and sent to us immediately. Valid in USA only.**

**We recommend you write your serial number here in your owners manual and on your sales receipt for your records.**

**SERIAL NUMBER:** \_\_\_\_\_ **PURCHASE DATE:** \_\_\_\_\_

