

# BF-3 Flanger

## Owner's Manual

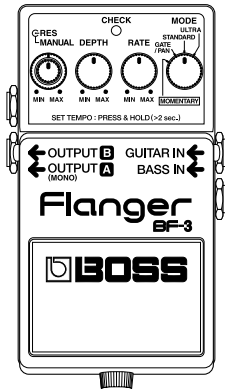

**BOSS**<sup>®</sup>

---

Thank you, and congratulations on your choice of BOSS BF-3 Flanger.

Before using this unit, carefully read the sections entitled: “USING THE UNIT SAFELY” and “IMPORTANT NOTES” (separate sheet). These sections provide important information concerning the proper operation of the unit. Additionally, in order to feel assured that you have gained a good grasp of every feature provided by your new unit, this manual should be read in its entirety. The manual should be saved and kept on hand as a convenient reference.

**A battery is supplied with the unit. The life of this battery may be limited, however, since its primary purpose was to enable testing.**

**Copyright © 2001 BOSS CORPORATION**

**All rights reserved. No part of this publication may be reproduced in any form without the written permission of BOSS CORPORATION.**

---

## Features

- Stereo output gives your sound greater breadth along with a deep effect that imparts a sense of three-dimensional rotation.
- Includes a new “ULTRA” mode for a more intense flanging effect.
- Also features a “GATE/PAN” mode. When outputting in mono, a slicer effect is added to the flanging sound, resulting in a “gate flanger” effect; and when using stereo output, you get a flanging effect that is panned three-dimensionally across the sound field.
- Includes a “MOMENTARY” mode, which allows you to apply the flanger effect exactly at the point in a phrase you want.
- Also includes a “Tap Tempo” function that lets you set the RATE to the tempo at which the pedal is pressed.

# Panel Description

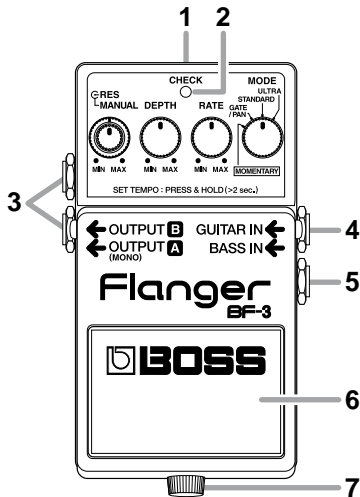

## 1. AC Adaptor Jack

Accepts connection of an AC Adaptor (optionally available BOSS PSA-Series). By using an AC Adaptor, you can play without being concerned about how much battery power you have left.

- \* Use only the specified AC adaptor (PSA-Series), and make sure the line voltage at the installation matches the input voltage specified on the AC adaptor's body. Other AC adaptors may use a different polarity, or be designed for a different voltage, so their use could result in damage, malfunction, or electric shock.
- \* As soon as you connect the AC adaptor, the unit is turned on.
- \* If there is battery in the unit while an AC adaptor is being used, normal operation will continue should the line voltage be interrupted (power blackout or power cord disconnection).

---

## 2. CHECK Indicator

This indicator shows whether an effect is ON/OFF, indicates the tempo (TEMPO mode: p. 11–12), and also doubles as the Battery Check indicator.

The indicator lights when an effect is ON.

- \* *If this indicator goes dim or no longer lights while an effect is ON or while the BF-3 is in TEMPO mode, the battery is near exhaustion and should be replaced immediately. For instructions on changing the batteries, refer to “Changing the Battery” (p. 14).*
- \* *The CHECK indicator shows whether the effect is being applied or not, and is used to indicate other effects. It does not indicate whether the power to the device is on or not.*

## 3. OUTPUT A (MONO)/ OUTPUT B Jack

The output jacks are used to connect the unit to an amplifier or another effects unit. For monaural use, make the connection to the OUTPUT A (MONO) jack.

## 4. GUITAR IN Jack

This jack accepts input signals (coming from a guitar, some other musical instrument, or another effects unit).

## 5. BASS IN Jack

This jack accepts input signal coming from a bass guitar.

- \* *BASS IN is disabled when the GUITAR IN jack is used.*
- \* *When running the unit on battery power, the GUITAR IN and BASS IN jacks double as power switches. Power to the unit is turned*

on when you plug into the GUITAR IN or BASS IN jack; the power is turned off when the cable is unplugged. Be sure to disconnect any cord plugged into the GUITAR IN or BASS IN jack when not using this effects device.

### 6. Pedal Switch

Used for switching effects on/off, and for inputting the tempo.

\* You cannot input the tempo in MOMENTARY mode.

### 7. Thumbscrew

When this screw is loosened, the pedal will open, allowing you to change the battery.

\* For instructions on changing the batteries, refer to “Changing the Battery” (p. 14).

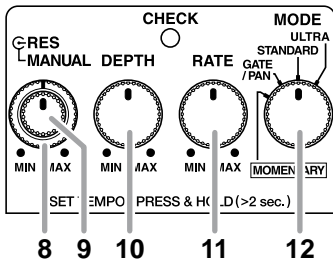

### 8. MANUAL Knob

Adjusts the center frequency to which the effect is applied.

The range is raised as you turn the knob to the right (clockwise).

\* The settings range varies with the selected mode, as well as when an instrument is connected to BASS IN.

## 9. RES (resonance) Knob

Adjusts the amount of resonance (feedback). The more the knob is turned to the right, the more the flanger sound is emphasized, and the stronger the characteristic effect in the sound becomes.

## 10. DEPTH Knob

Adjusts the sweep depth. The effect deepens as you turn the knob to the right.

*\* The MANUAL knob has no function when this knob is turned completely clockwise.*

## 11. RATE Knob

Adjusts the rate of the flanging. The flange effect speeds up as you turn the knob to the right.

## 12. MODE Knob

Selects the flanger effect and pedal mode.

### ULTRA:

Provides a stronger flanger effect than STANDARD.

### STANDARD:

Provides a normal flanger effect.

### GATE/PAN:

When playing in mono, this creates radical changes in the output volume. When playing in stereo, this alternately pans the output to the left and right, resulting in a flanger effect that imparts a sense of rotation or spinning.

### MOMENTARY:

The flanger effect is applied only while the BF-3's pedal is depressed. The STANDARD tone is applied, and flanging starts in the low end.

*\* You cannot input the tempo in MOMENTARY mode.*

# Connections

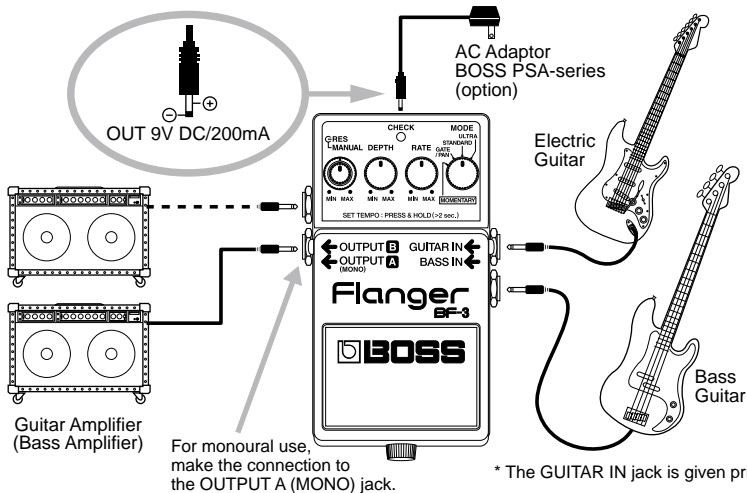



- 
- \* *Inserting a plug into the GUITAR IN or BASS IN Jack will automatically switch the unit on.*
  - \* *The use of an AC adaptor is recommended as the unit's power consumption is relatively high. Should you prefer to use batteries, please use the alkaline type.*
  - \* *Noise may be produced if wireless communications devices, such as cell phones, are operated in the vicinity of this unit. Such noise could occur when receiving or initiating a call, or while conversing. Should you experience such problems, you should relocate such wireless devices so they are at a greater distance from this unit, or switch them off.*
  - \* *To prevent malfunction and/or damage to speakers or other devices, always turn down the volume, and turn off the power on all devices before making any connections.*
  - \* *If there are batteries in the unit while an AC adaptor is being used, normal operation will continue should the line voltage be interrupted (power blackout or power cord disconnection).*
  - \* *Once the connections have been completed (p. 8), turn on power to your various devices in the order specified. By turning on devices in the wrong order, you risk causing malfunction and/or damage to speakers and other devices.*  
*When powering up: Turn on the power to your guitar amp **last**.*  
*When powering down: Turn off the power to your guitar amp **first**.*
  - \* *Always make sure to have the volume level turned down before switching on power. Even with the volume all the way down, you may still hear some sound when the power is switched on, but this is normal, and does not indicate a malfunction.*
  - \* *When operating on battery power only, the unit's indicator will become dim when battery power gets too low. Replace the battery as soon as possible.*
-

# Operating the Unit

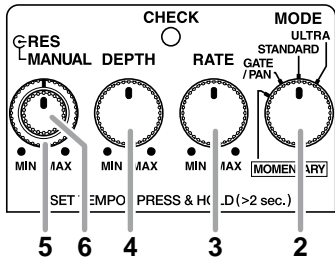

1. When you have made the necessary connections (p. 8), depress the pedal switch to turn the effect on. (the CHECK indicator turns red.)









\* When *MOMENTARY* mode is selected, continue pressing the pedal switch. (the effect is on only while the pedal is depressed)

2. Select the mode with the MODE knob.  
\* When *MOMENTARY* is selected, the CHECK indicator light goes off, and the effect is switched off. Hold the pedal down when using the following settings in *MOMENTARY* mode (the effect is on only while the pedal is depressed).
3. Set the flanging rate with the RATE knob.
4. Set the sweep depth with the DEPTH knob.
5. Set the center frequency to which the effect is applied with the MANUAL knob.
6. Turn the RES knob to set the strength of the effect.

## Setting the RATE by Inputting the Tempo with the Pedal Switch

### When Switching to Tempo Input with the Effect ON (CHECK indicator: Red)

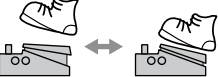
\* RATE cycles for use with the tempo settings can be made in the range of 0.1–18 seconds.

<b>CHECK Indicator</b>	Red 	Off 	Red/Green Blinking 	Red 
<b>Flanger Effects</b>	On	Off	On	Off
<b>Pedal Switch</b>		 <b>1</b> Press and hold the BF-3's pedal switch for at least two seconds.	 <b>2</b> Press the BF-3's pedal switch in timing with the tempo.	 <b>3</b> Press and hold the BF-3's pedal switch for at least two seconds.
<b>RATE</b>	Effect reflects knob positions		Effect synchronized to tempo	









\* If you carry out Step **3** immediately after Step **2**, Step **3** may inadvertently be interpreted as tempo input, thus changing the RATE setting. Allow a brief interval to pass before progressing from Step **2** to Step **3**.

\* If you adjust the RATE knob after completing the settings, the effect then reflects the position of the RATE knob.

\* You cannot input the tempo in MOMENTARY mode.

## When Switching to Tempo Input with the Effect OFF (CHECK indicator: Off)

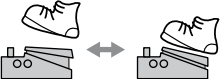
\* RATE cycles for use with the tempo settings can be made in the range of 0.1–18 seconds.

<b>CHECK Indicator</b>	Off 	Red 	Red/Green Blinking 	Red 
<b>Flanger Effects</b>	Off	On	On	Off
<b>Pedal Switch</b>		 <b>1</b> Press and hold the BF-3's pedal switch for at least two seconds.	 <b>2</b> Press the BF-3's pedal switch in timing with the tempo.	 <b>3</b> Press and hold the BF-3's pedal switch for at least two seconds.
<b>RATE</b>	Effect reflects knob positions		Effect synchronized to tempo	

\* If you carry out Step **3** immediately after Step **2**, Step **3** may inadvertently be interpreted as tempo input, thus changing the RATE setting. Allow a brief interval to pass before progressing from Step **2** to Step **3**.

\* If you adjust the RATE knob after completing the settings, the effect then reflects the position of the RATE knob.

\* You cannot input the tempo in MOMENTARY mode.

## Relationship Between the Flanger and Gate Effects

- \* The gate effect switches on and off 32 times over the period of the flanger effect's rise and fall.
- \* If you want to have the gate working on eighth notes, press the pedal switch at the beginning of the fourth measure of the song you want to have synchronized.

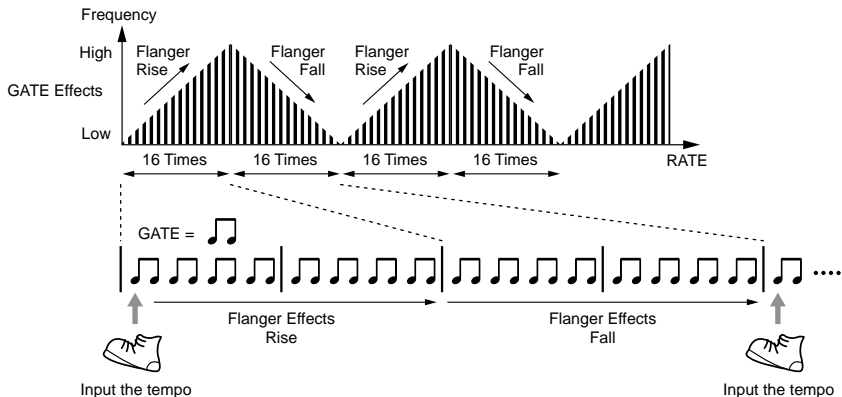

# Changing the Battery

When the indicator goes dim or no longer lights while an effect is on, it means that the battery is nearly dead and must be replaced. Replace the battery following the steps below.

\* *This device consumes considerable power, so use of the AC adaptor is recommended. When powering the unit with batteries, use alkaline batteries.*

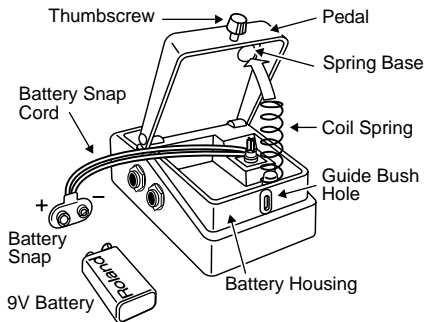

1. Loosen the thumbscrew at the front of the pedal, then lift the pedal upwards to open the unit.
  - \* *The thumbscrew can be left in the pedal while changing the battery.*
2. Remove the old battery from the battery housing, and remove the snap cord connected to it.
3. Connect the snap cord to the new battery, and place the battery inside the battery housing.
  - \* *Be sure to carefully observe the battery's polarity (+ versus -).*
4. Slip the coil spring onto the spring base on the back of the pedal, then close the pedal.
  - \* *Carefully avoid getting the snap cord caught in the coil spring.*
5. Finally, insert the thumbscrew into the guide bush hole and fasten it securely.

# Troubleshooting

## Power won't come on:

- **Is the specified adaptor (PSA-series; sold separately) properly connected?**

Check the connection once more (p. 8).

*\* Never use any AC adapter other than one specified for use with the BF-3.*

- **Is the battery low or dead?**

Replace with a new battery (p. 14).

- **Is the guitar connected properly to the GUITAR IN or BASS IN jack?**

Check the connection once more (p. 8).

*\* To prevent excess battery drainage, turn the power on without the plug inserted in the GUITAR IN or BASS IN jack.*

*\* The battery that was supplied with the unit is for temporary use-intended primarily for testing its operation. For using the unit for more extended periods of time, we recommend the use of alkaline batteries.*

*\* The CHECK indicator shows whether the effect is being applied or not, and is used to indicate other effects. It does not indicate whether the power to the device is on or not.*

## CHECK indicator doesn't light:

- **Is the MODE knob set to MOMENTARY?**

When in MOMENTARY mode, the CHECK indicator light is normally off (the effect is off). The indicator lights (the effect is on) only while the pedal is depressed.

The CHECK indicator lights up for several seconds immediately after the power is turned on.

### **No sound / Low volume:**

- **Is the BF-3 properly connected to your instrument?**  
Check the connection once more (p. 8).
- **Is the volume turned down on any guitar amp or effects device you have connected?**
- **Are you inputting to both the GUITAR IN and BASS IN jacks?**  
The GUITAR IN jack is given priority. If both jacks are used at the same time, the signal that has been applied at BASS IN will not be heard.

### **Sound is distorted:**

- **Is the battery low?**  
As the battery is drained, the CHECK indicator dims, and the BF-3 may start to function incorrectly. Replace with a new battery (p. 14).

- **Could the level of the sound being input be excessive?**  
With some guitars, distortion may be produced. Be careful of your guitar's output level.

### **Can't input the tempo:**

- **Is the MODE knob set to MOMENTARY?**  
In MOMENTARY mode, the pedal switch only functions as an effect on/off switch.

### **Tempo not synchronized with the tempo input:**

- **Is the MODE knob set to GATE?**  
When synchronizing to GATE, please refer to "Relationship Between the Flanger and Gate Effects" (p. 13).



# Setting Samples

## For Guitar

### Standard Flanger

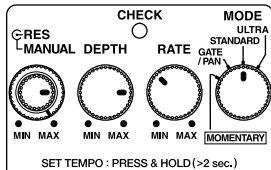

### Stereo Flanger

Stereo  
Out

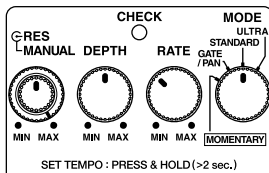

### Ultra Flanger

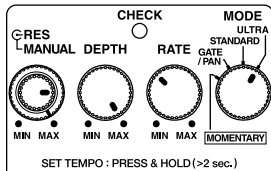

### Rotary Flanger

Stereo  
Out

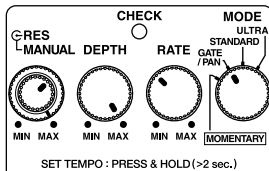

## For Guitar

### Gate Flanger

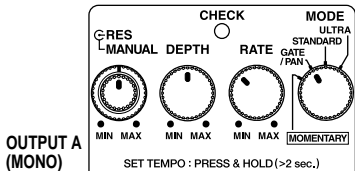

### Tremolo Flanger

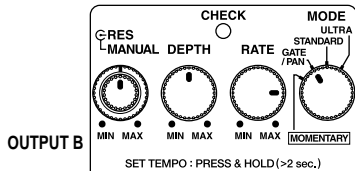

### Chorus Sound

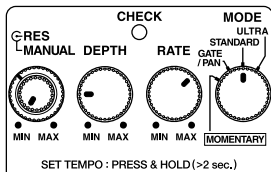

### Fixed Flanging

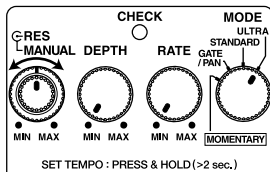

## For Bass

### Strong Flanging

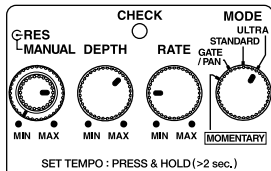

### Vibrato Sound

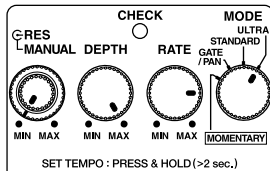

### Deep Flanger

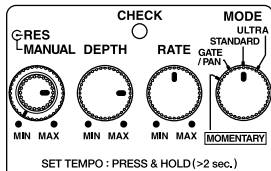

### Slicer Sound

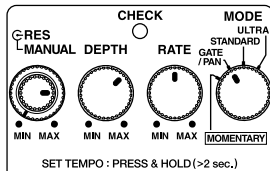

# Setting Memo

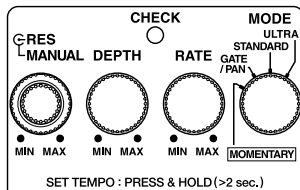
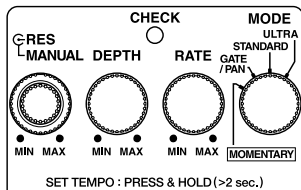
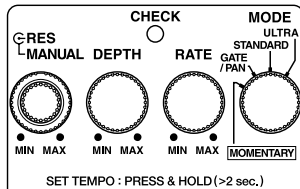
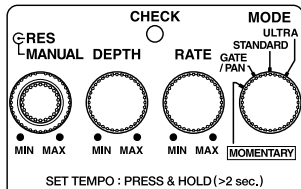

# Specifications

## BF-3: Flanger

Nominal Input Level.....	-20 dBu
Input Impedance.....	1 M $\Omega$
Nominal Output Level.....	-20 dBu
Output Impedance .....	1 k $\Omega$
Recommended Load Impedance ....	10 k $\Omega$ or greater
Delay Time.....	0.3 mS–14.4 mS (GUITAR IN) 0.3 mS–6.3 mS (BASS IN)
LFO Speed .....	100 mS–18 S
Residual Noise .....	-95 dBu (IHF-A Typ.)
Controls.....	Pedal Switch, MANUAL Knob, RES (resonance) Knob, DEPTH Knob, RATE Knob, MODE Knob
Indicator .....	CHECK Indicator (Serves also as tempo and battery check indicator)
Connectors.....	GUITAR IN Jack, BASS IN Jack, OUTPUT A (MONO) Jack, OUTPUT B Jack, AC adaptor Jack (DC 9 V)
Power Supply.....	DC 9 V; Dry battery (9 V type) S-006P/9 V (6F22/9 V) Dry battery (9 V type) 6AM6/9 V (alkaline) AC Adaptor (PSA-series: optional)

## Specifications

---

Current Draw .....	40 mA (DC 9 V)
	<i>* Expected battery life under continuous use: Carbon: 3 hours Alkaline: 10 hours These figures will vary depending on the actual conditions of use.</i>
Dimensions .....	73 (W) x 129 (D) x 59 (H) mm 2-7/8 (W) x 5-1/8 (D) x 2-3/8 (H) inches
Weight .....	420 g / 15 oz (including Battery)
Accessories.....	Owner's Manual Leaflet ("USING THE UNIT SAFELY," "IMPORTANT NOTES," and "Information") Dry battery (9 V type) S-006P/9 V (6F22/9 V) <i>* The battery that was supplied with the unit is for temporary use-intended primarily for testing its operation.</i>
Options.....	AC Adaptor PSA-Series

*\* 0 dBu = 0.775 Vrms*

*\* In the interest of product improvement, the specifications and/or appearance of this unit are subject to change without prior notice.*



For EU Countries

This product complies with the requirements of European Directive 89/336/EEC.

For the USA

## FEDERAL COMMUNICATIONS COMMISSION RADIO FREQUENCY INTERFERENCE STATEMENT

This equipment has been tested and found to comply with the limits for a Class B digital device, pursuant to Part 15 of the FCC Rules. These limits are designed to provide reasonable protection against harmful interference in a residential installation. This equipment generates, uses, and can radiate radio frequency energy and, if not installed and used in accordance with the instructions, may cause harmful interference to radio communications. However, there is no guarantee that interference will not occur in a particular installation. If this equipment does cause harmful interference to radio or television reception, which can be determined by turning the equipment off and on, the user is encouraged to try to correct the interference by one or more of the following measures:

- Reorient or relocate the receiving antenna.
- Increase the separation between the equipment and receiver.
- Connect the equipment into an outlet on a circuit different from that to which the receiver is connected.
- Consult the dealer or an experienced radio/TV technician for help.

---

This device complies with Part 15 of the FCC Rules. Operation is subject to the following two conditions:

- (1) This device may not cause harmful interference, and
- (2) This device must accept any interference received, including interference that may cause undesired operation.

---

Unauthorized changes or modification to this system can void the users authority to operate this equipment.  
This equipment requires shielded interface cables in order to meet FCC class B Limit.

For Canada

### NOTICE

This Class B digital apparatus meets all requirements of the Canadian Interference-Causing Equipment Regulations.

### AVIS

Cet appareil numérique de la classe B respecte toutes les exigences du Règlement sur le matériel brouilleur du Canada.



**BOSS Corporation**

G6017305